

EPSON

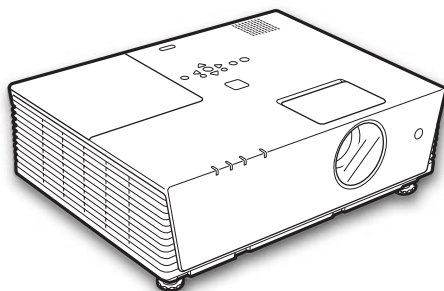

Multimedia Projector

EMP-6100 EMP-6000



EN Quick Start Guide

DE Kurzanleitung

FR Guide de démarrage rapide

IT Guida di avvio rapido

ES Guía de inicio rápido

PT Guia de Referência Rápida

NL Introductiehandleiding

DA Introduktion

FI Pika-aloitusopas

NO Hurtigveiledning

SV Snabbstartsguide

CS Úvodní příručka

HU Bevezetés

PL Przewodnik szybkiego startu

SK Stručná príručka

BG Ръководство за бърз старт

RO Ghid de pornire rapidă

EE Lühijuhend

LV Ātrās darba uzsākšanas pamācība

LT Trumpas pradžios vadovas

EL Οδηγός γρήγορης εκκίνησης

TR Hızlı Başlangıç Kılavuzu

SL Priročnik za hitri zagon

HR Kratke upute

MK Прирачник брз почеток

SR Uputstvo za brz početak

RU Руководство по быстрой установке

AR دليل البداية السريعة

FA راهنمای سریع برای شروع بکار

TC 設定説明書

SC 设定手册

EN	For detailed information, refer to the Safety Instructions and the User's Guide on the Document CD-ROM.
DE	Weitere Informationen finden Sie in den Sicherheitsanweisungen und in der Bedienungsanleitung auf der CD-ROM mit der Dokumentation.
FR	Pour des informations détaillées, consultez les Consignes de sécurité et le Guide de l'utilisateur figurant sur le CD-ROM de documentation.
IT	Per informazioni dettagliate, consultare la sezione relativa alle Istruzioni sulla sicurezza e il Manuale dell'utente disponibili nel CD-ROM della documentazione.
ES	Para obtener información detallada, consulte las Instrucciones de seguridad y el Manual de usuario en el CD-ROM de la documentación.
PT	Para mais informações, consulte as Instruções de Segurança e o Manual do Utilizador no CD-ROM com documentação.
NL	Raadpleeg voor meer informatie de Veiligheidsvoorschriften en de Gebruikershandleiding op de cd-rom met documentatie.
DA	Yderligere oplysninger finder du i Sikkerhedsinstruktionerne samt i Brugerhåndbogen på cd-rom'en med dokumenter.
FI	Lisätietoja on Turvaohjeissa ja dokumentaatio-CD-levyllä olevassa Käyttäjän oppaassa.
NO	Du finner mer detaljert informasjon i Brukerhåndboken og i Sikkerhetsinstruksjonene på dokument-CD-ROMen.
SV	Se Bruksanvisningen och Säkerhetsinstruktionerna på cd-rom-skivan med dokument för ytterligare information.
CS	Podrobné informace naleznete v Bezpečnostních pokynech a Uživatelské příručce na disku Documentace CD-ROM.
HU	Részletesebb információk a CD-ROM-on lévő Biztonsági előírásokban és a Használati útmutatóban találhatók.
PL	Szczegółowe informacje zawierają Instrukcje dotyczące bezpieczeństwa oraz Przewodnik użytkownika na dysku CD-ROM z dokumentacją.
SK	Podrobné informácie nájdete v Bezpečnostných pokynoch a Príručke používateľa na disku Documentacion CD-ROM.
BG	Подробна информация можете да намерите в Инструкциите за безопасност и Ръководството за потребителя в компактдиска с документация.

RO	Pentru informații detaliate, consultați Instrucțiunile pentru lucrul în siguranța și Ghidul utilizatorului de pe CD-ul cu documentație.
EE	Lähemat teavet vaata ohutusjuhistest ja kasutusjuhendist dokumentatsiooni CD-ROM-ilt.
LV	Sīkāka informācija atrodama drošības instrukcijā un lietotāja rokasgrāmatā uz kompaktdiska.
LT	Detalios informacijos ieškokite saugumo instrukcijoje ir vartotojo žinyne, esančiame dokumentacijos kompaktiniame diske.
EL	Για λεπτομερείς πληροφορίες, ανατρέξτε στις Οδηγίες για την ασφάλεια και στο Εγχειρίδιο χρήσης στο αρχείο στο CD-ROM.
TR	Ayrıntılı bilgi için Documents (Dokümanlar) CD'sindeki Güvenlik Talimatlarına ve Kullanım Kılavuzuna başvurun.
SL	Podrobne informacije najdete v Varnostnih navodilih in Uporabniškim priločniku na zgoščenki.
HR	Detaljnije informacije potražite u Sigurnosnim uputama i Korisničkom uputama na CD-ROM-u s dokumentima.
MK	За детална информација погледнете во напатствието за безбедност и прирачникот за употреба на ЦД-РОМ - од со документи.
SR	Detaljnije informacije naći ćete u Sigurnosnim uputstvima u Korisničkom uputstvu na CD-ROM-u sa dokumentacijom.
RU	Для получения дополнительной информации см. Правила техники безопасности и Руководство по эксплуатации на компакт-диске с документацией.
AR	للمعلومات تفصيلية، ارجع إلى "تعليمات الأمان" و"دليل المستخدم" الموجودة بالمرجع الموجودة بالقرص المضغوط.
FA	برای اطلاعات مشروح، به "دستورالعملهای ایمنی" و "راهنمای کاربر" بروی دیسک فشرده اسناد مراجعه شود.
TC	有關詳細資訊，請參閱 Document CD-ROM 中的安全使用須知和使用說明書。
SC	有关详细信息，请参阅 Document CD-ROM 中的安全使用须知和使用说明书。

EN	Content of the box	RO	Conținutul cutiei
DE	Packungsinhalt	EE	Kasti sisu
FR	Contenu de la boîte	LV	Komplektācija
IT	Contenuto della confezione	LT	Dėžės turinys
ES	Contenido del paquete	EL	Περιεχόμενα της συσκευασίας
PT	Conteúdo da embalagem	TR	Kutunun içeriği
NL	Inhoud van de doos	SL	Vsebina paketa
DA	Æskens indhold	HR	Sadržaj paketa
FI	Laatikon sisältö	MK	Содржина на кутијата
NO	Innholdet i esken	SR	Sadržaj kutije
SV	Innehåll i lådan	RU	Содержимое упаковки
CS	Obsah balení	AR	محتوى الصندوق
HU	A doboz tartalma	FA	محتویات جعبه
PL	Zawartość opakowania	TC	包裝箱內容
SK	Obsah balenia	SC	包裝箱內容
BG	Съдържание на кутията		

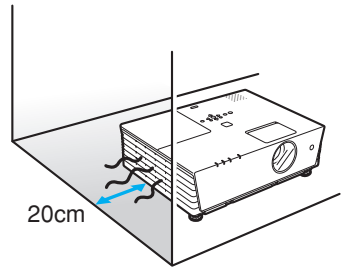
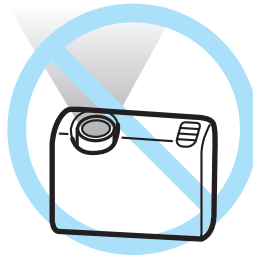
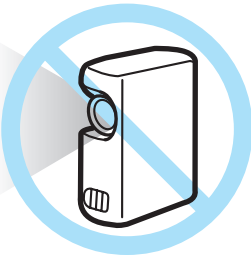
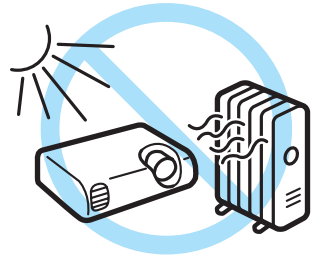
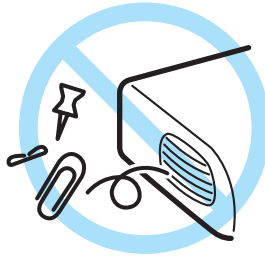
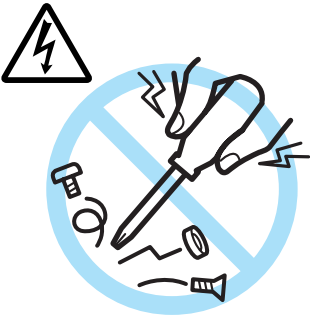

1

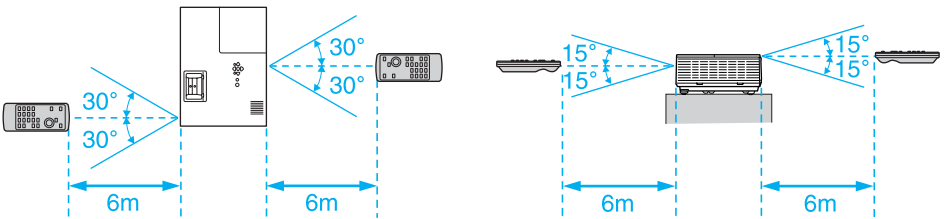
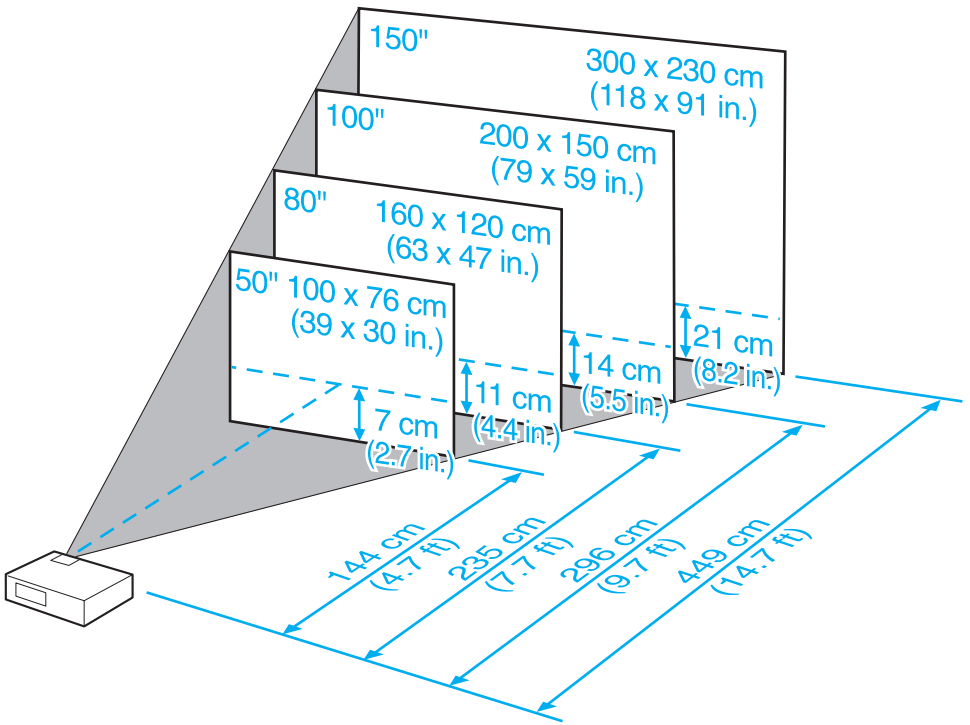

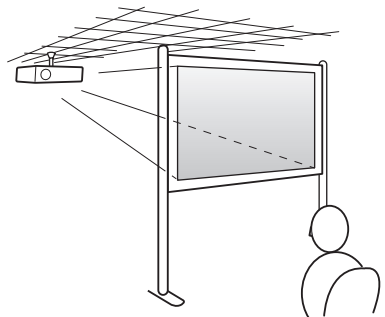
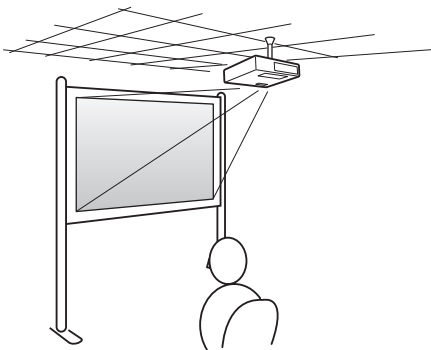
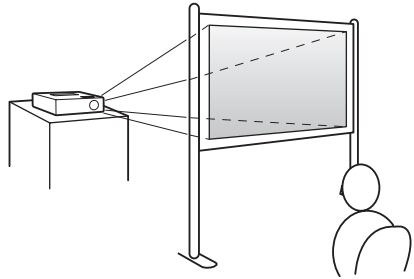
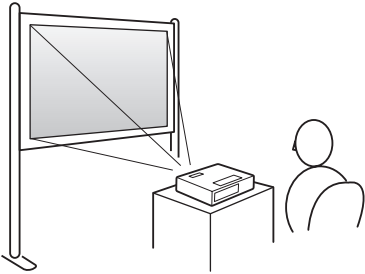
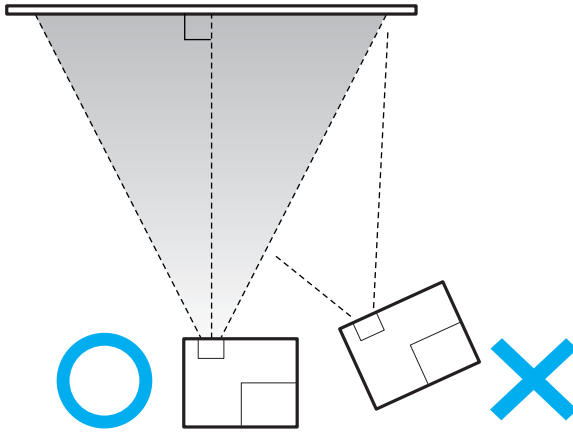

2

EMP-6100

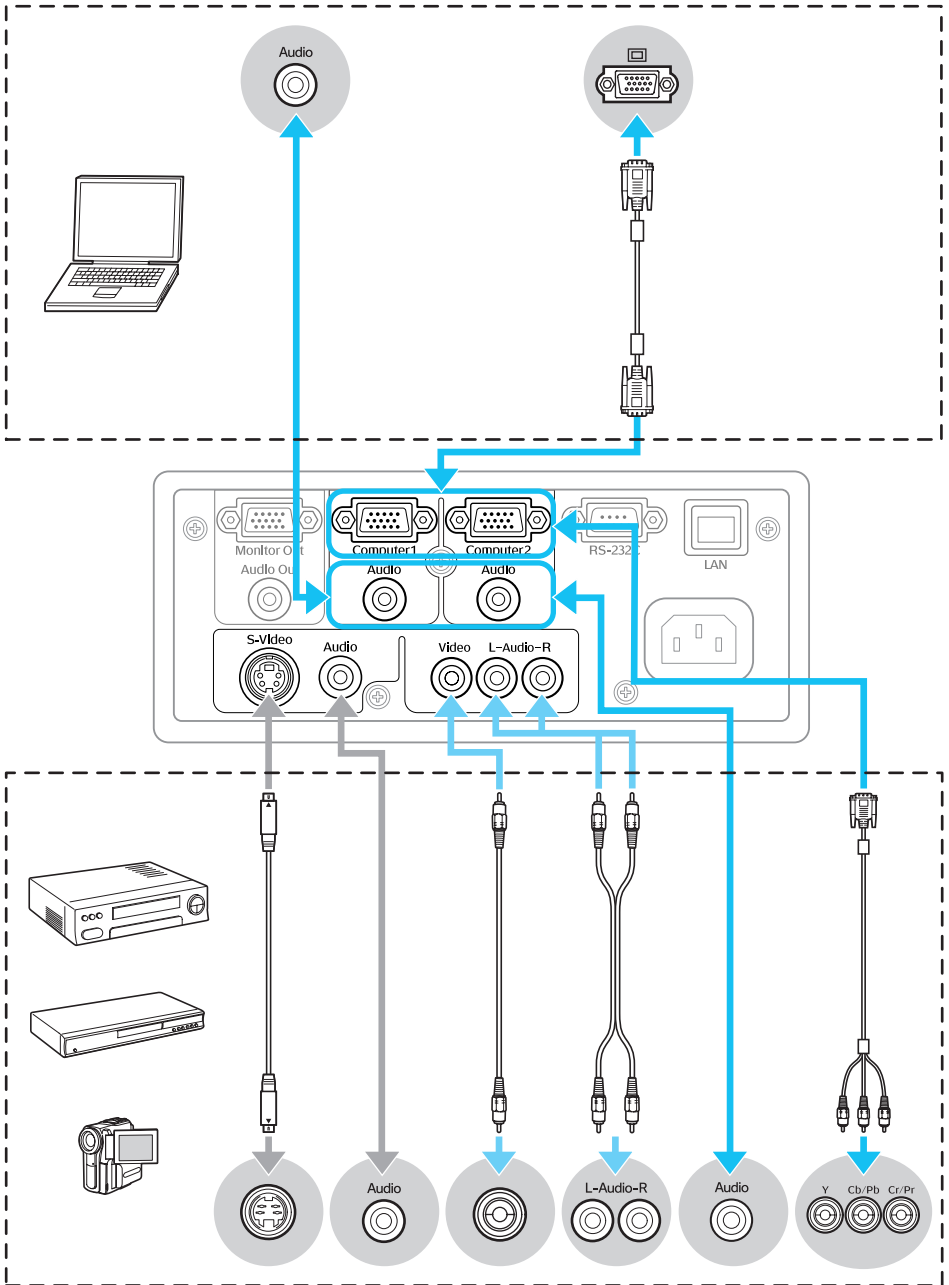

EMP-6000

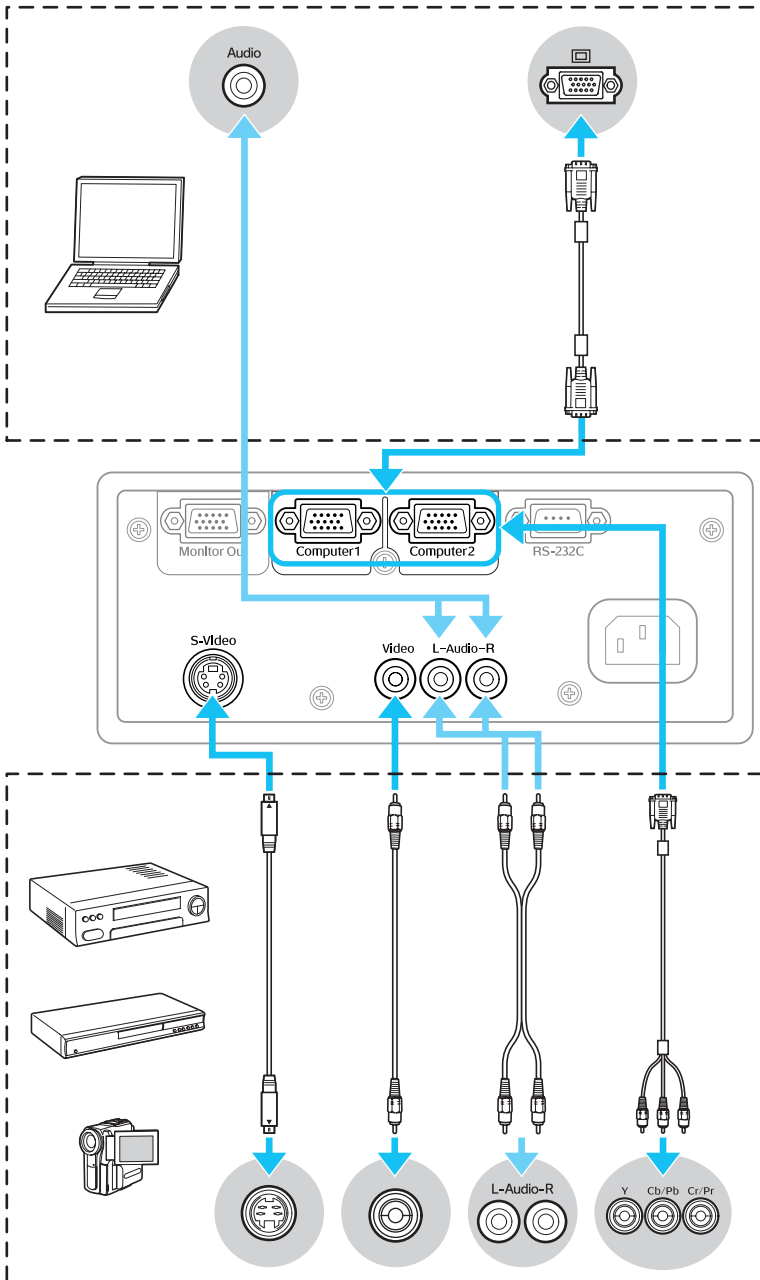

3

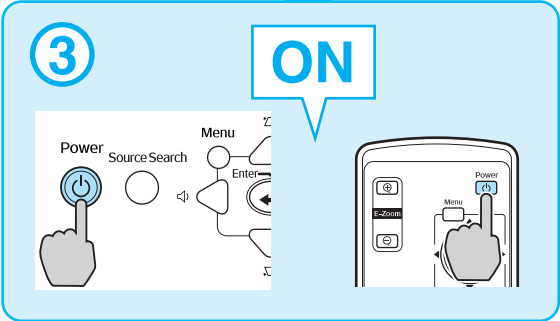
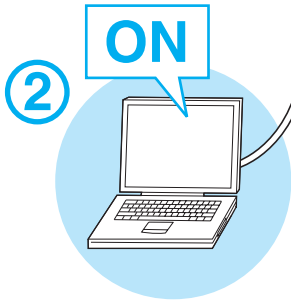
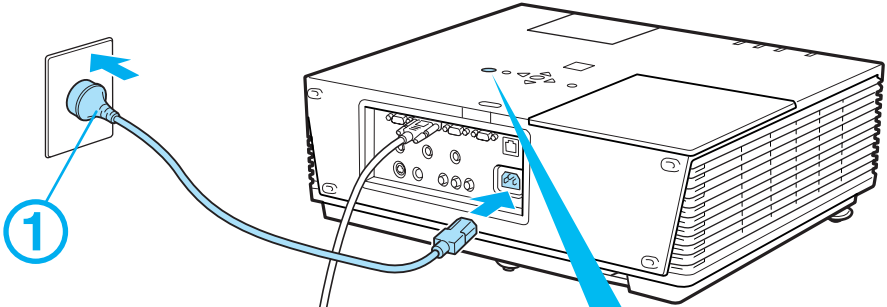

4

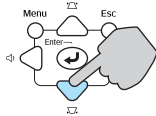
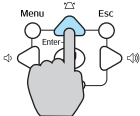
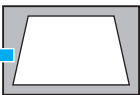
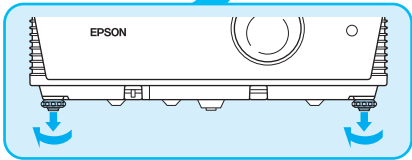
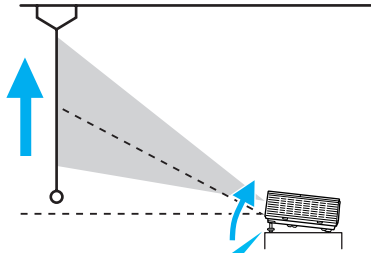
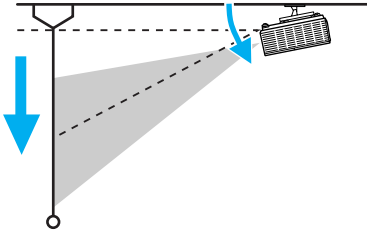
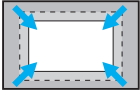
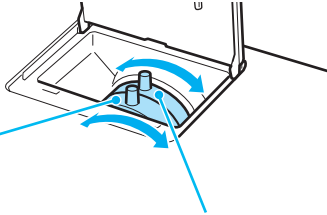
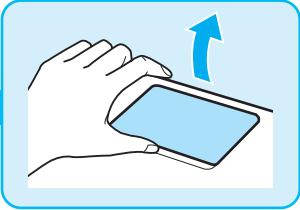
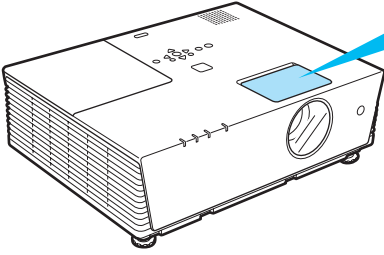

5

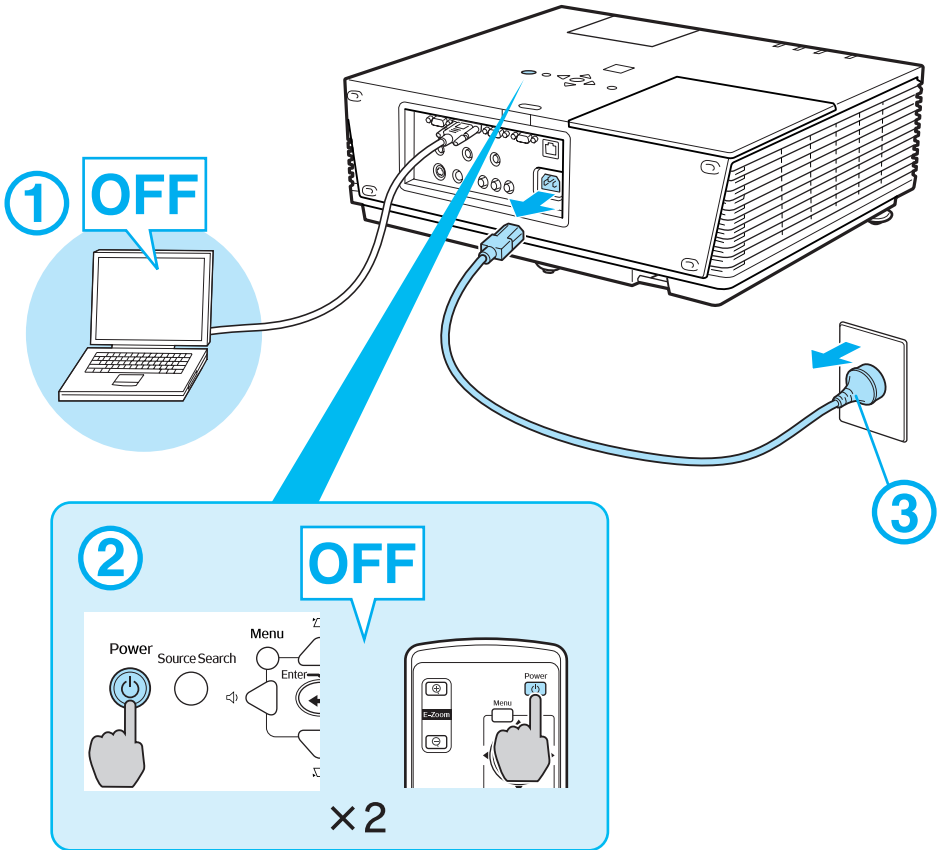

EMP-6100

