

EPSON®

EMP-7850 User's Guide





Features of the Projector

Network Correspondence

Some examples of the projector's many useful functions include:

- Projecting images from a computer connected via a network.
- Automatically sending email notifications if errors occur with the projector, such as if the lamp cuts out during projection.

Before using EasyMP, refer to the *EasyMP Setup Guide* and *EasyMP Operation Guide*.

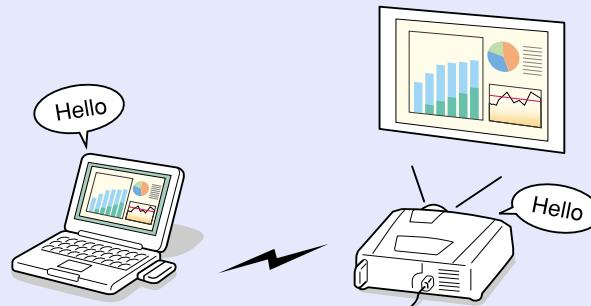

Position adjustment function for a variety of projection screens

Images can be projected regardless of the location.

- The keystone distortion that occurs as a result of the projector being tilted using the front adjustable foot can be corrected. (Automatic keystone correction [p.46](#))
- The keystone distortion that occurs when projecting from the side of the screen can also be corrected. (Vertical correction and horizontal correction [p.47](#))

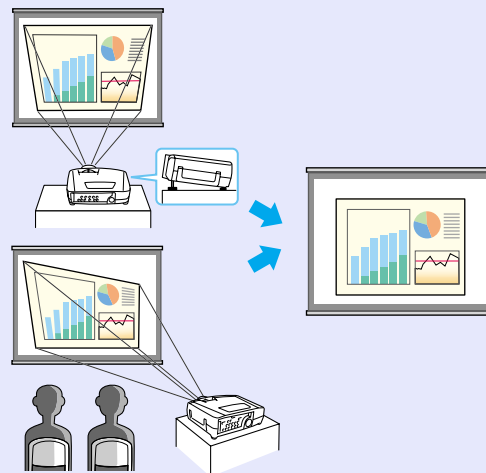

- If vertical keystone correction causes the height of projected images to be too short, the height of the projection area can also be adjusted. (Height correction [p.48](#))



- The Quick Corner function can be used to correct the four corners of the projection area to make the images fit the screen exactly. [p.49](#)



Wall Shot

Images can be projected in places without a screen with no loss of original colour.

This automatically adjusts image colours to their natural colours even when projecting onto surfaces such as blackboards and partitions. [p.51](#)

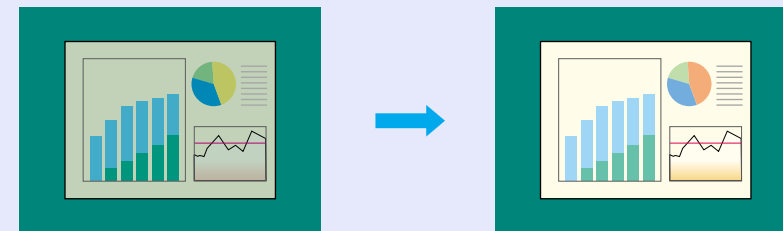



Colour mode function

Optimum images can be projected simply by selecting the image quality from the following five preset settings according to the projection environment being used. No other colour adjustments are necessary.

☞ p.56

• Dynamic • Presentation • Theatre • Living Room • [sRGB](#)

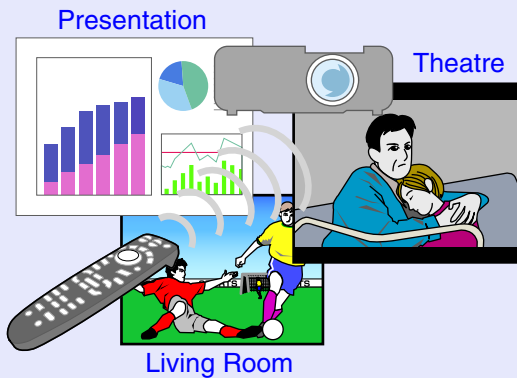

Effects functions

These functions allow you to indicate important points using a pointer and draw straight lines and freehand curves to help make explanations easier to understand. ☞ p.66

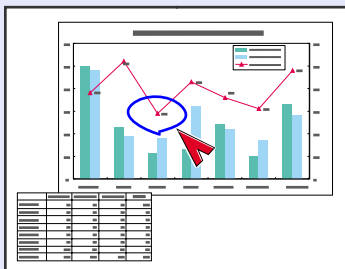

Brilliant, attractive images

The projector can display images at high resolutions with a high degree of luminance.

In addition, images can be switched to low luminance if they are too bright when projecting in dark rooms or onto small screens. ☞ p.89

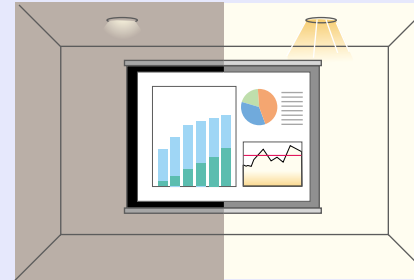



Features of the Projector	1
---------------------------------	---

Before Using the Projector

Part Names and Functions	6
Front/Top/Side	6
Base	7
Rear	7
Remote Control	8
Control Panel	9
Input/Output Ports	10
Before Using the Remote Control	11
Inserting the Batteries	11
Using the Remote Control and Remote Operating Range	12
Installation	14
Setting Up the Projector	14
Screen Size and Projection Distance	15
Inserting and Removing Cards	16
Installation	16
Removal	17
Connecting to a Computer	18
Eligible Computers	18
Projecting Images from the Computer	19
If Connecting More Than One Computer	23
Using the Remote Control to Operate the Mouse Pointer (Wireless Mouse Function)	24
Connecting an External Monitor	26
Connecting to a Video Source	27
Projecting Composite Video Images	27
Projecting S-Video Images	28
Projecting Component Video Images	28
Projecting RGB Video Images	29

Playing Sound from the Video Equipment	31
Playing Sound from External Speakers	32
Connecting to a Digital Camera	33
Connecting to a Digital Camera Using a USB Cable	33
Removing the USB Cable from the Projector	33

Basic Operations

Turning the Projector On	35
Connecting the Power Cable	35
Turning the Power On and Projecting Images	36
Selecting an Image Source While Viewing Projected Images (Preview Function)	38
Turning the Projector Off	40
Adjusting the Screen Image	42
Adjusting the Image Size (Zoom Function)	42
Focusing the Screen Images (Focus Adjustment)	42
Adjusting the Image Angle	43
Manually Correcting Keystone Distortion	45
Adjusting the Image Quality	51
Projecting Easy-to-see Images Without a Screen (Wall Shot)	51
Adjusting Computer Images	53
Selecting the Projection Quality (Colour Mode Selection)	56
Adjusting the Volume	57
Preventing theft (Password Protect)	58
When Password Protect is enabled	58
Entering a password with the remote control	59
Changing the Password Protect settings	59





Advanced Operations

Functions for Enhancing Projection	62
A/V Mute Function	62
Freeze Function	63
E-Zoom Function	63
P in P (Picture in Picture) Function.....	64
Effect Function	66
Preset Function	68
Changing the Resize/Aspect Ratio	70
Projector ID/Remote Control ID	73
Using the Configuration Menu Functions.....	75
List of Functions.....	76
Using the Configuration Menus	92

Troubleshooting

Using the Help	95
Problem Solving.....	97
Reading the Indicators.....	97
When the Indicators Provide No Help	100

Appendices

Maintenance	119
Cleaning.....	119
Replacing Consumables	120
Saving a User's Logo	126
Optional Accessories.....	129
Glossary	130
List of ESC/VP21 Commands	133
Command List	133
Communication Protocol.....	133
Cable Layouts.....	134
USB Connection Setup.....	135
List of Supported Monitor Displays.....	136
Specifications	137
Appearance	139





Before Using the Projector

This chapter describes the procedures for setting up the projector before use.











Part Names and Functions.....	6	• Projecting Images from the Computer	19
• Front/Top/Side	6	• If the Monitor Port is a Mini D-Sub 15-pin Port	19
• Base.....	7	• If the Monitor Port is a 13w3 Port	20
• Rear	7	• If the Monitor Ports are a 5BNC Ports	21
• Remote Control	8	• If the Monitor Port is a Digital RGB Port.....	22
• Control Panel	9	• If Connecting More Than One Computer.....	23
• Input/Output Ports.....	10	• Using the Remote Control to Operate the	
Before Using the Remote Control	11	Mouse Pointer (Wireless Mouse Function)	24
• Inserting the Batteries	11	• Connecting an External Monitor	26
• Using the Remote Control and		Connecting to a Video Source	27
Remote Operating Range	12	• Projecting Composite Video Images	27
• Using the Remote Control.....	12	• Projecting S-Video Images.....	28
• Remote Operating Range	13	• Projecting Component Video Images	28
Installation	14	• Projecting RGB Video Images.....	29
• Setting Up the Projector	14	• If the RGB Output Port is a Mini D-Sub 15-pin Port	29
• Screen Size and Projection Distance.....	15	• If the RGB Output Ports are the 3BNC Ports	30
Inserting and Removing Cards	16	Playing Sound from the Video Equipment.....	31
• Installation	16	Playing Sound from External Speakers	32
• Removal.....	17	Connecting to a Digital Camera	33
Connecting to a Computer.....	18	• Connecting to a Digital Camera Using a USB Cable	33
• Eligible Computers	18	• Removing the USB Cable from the Projector	33



Part Names and Functions

The illustration below shows the projector with a standard lens fitted.

Front/Top/Side

-
- **Zoom ring**  [p.42](#)
Adjusts the image size.
 - **Focus ring**  [p.42](#)
Adjusts the image focus.
 - **Air exhaust vent**
 Do not touch during or immediately after projection, as it can become hot.
 - **Remote control light-receiving area**  [p.12](#)
Receives signals from the remote control.
 - **Foot adjust lever**  [p.44](#)
Pull out the foot adjust lever to extend and retract the front foot.
 - **Front adjustable foot**  [p.44](#)
Extend and retract to adjust the projection angle when the projector is placed on a surface such as a shelf.
 - **(Temperature) indicator**  [p.97](#)
Flashes or lights in different colours to indicate problems with the internal temperature of the projector.
 - **(Lamp) indicator**  [p.97](#)
Flashes or lights in different colours to indicate problems with the projection lamp.
 - **(Operation) indicator**  [p.97](#)
Flashes or lights in different colours to indicate the operating status of the projector.
 - **Control panel**  [p.9](#)
 - **Handle**
Use this handle when lifting and transporting the projector.
 - **Air filter (Air intake vent)**  [p.119](#), [p.125](#)
Prevents dust and other foreign particles from being drawn into the projector. Clean the air filters periodically.
 - **Lens cover**
Attach when not using the projector in order to prevent the lens from becoming dirty or damaged.



Part Names and Functions

Base

- **Suspension bracket fixing points (4 points)** [p.14](#), [p.129](#)

Connect an optional ceiling mount here when suspending the projector from the ceiling.

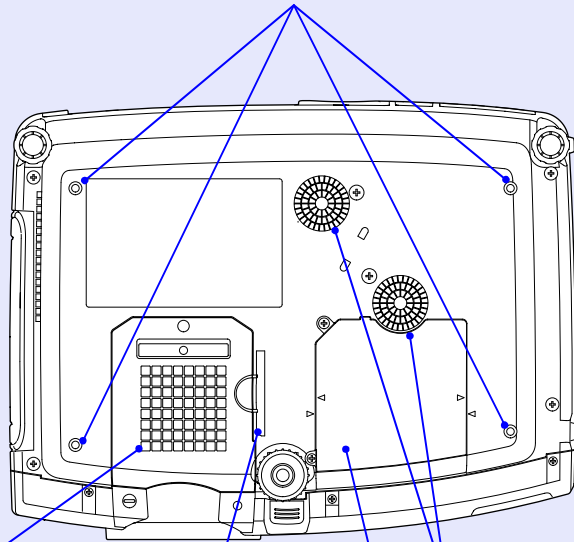

- **Air intake vent** [p.119](#)
Clean the air filters periodically.
- **Air filter** [p.119](#), [p.125](#)
Prevent dust and other foreign particles from being drawn into the projector. Clean the air filters periodically.
- **Air intake vents** [p.119](#)
Clean the air filters periodically.
- **Lamp cover** [p.121](#)
Open this cover when replacing the lamp inside the projector.

Rear



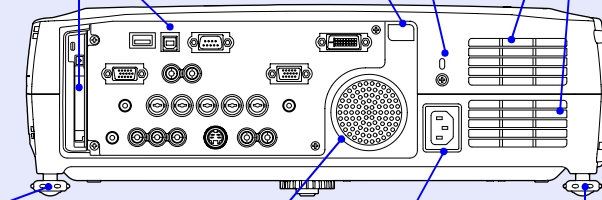









- **Security lock (🔒)** [p.131](#)
- **Remote control light-receiving area** [p.12](#)
Receives signals from the remote control.
- **Input/output ports** [p.10](#)
- **Card slot** [p.16](#)
- **Air intake vents** [p.119](#)
Clean the air filters periodically.
- **Rear adjustable foot**
- **Speaker**
- **Power inlet** [p.35](#)
Connect the power cable here.
- **Rear adjustable foot**











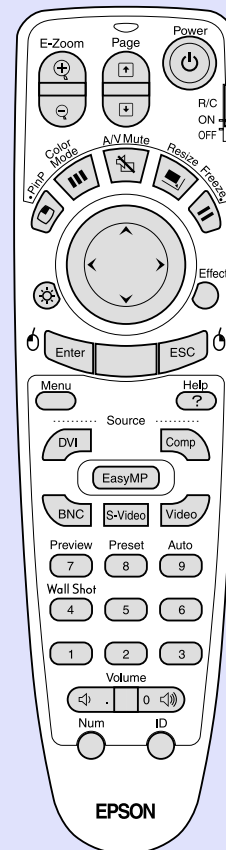









Remote Control

If you position the  over the button icon or button name, a description of that button will appear.

- Remote control light-emitting area  [p.13](#)
- Indicator
- [E-Zoom] buttons  [p.63](#)
- [Page] buttons  [p.24](#)
- [PinP] button  [p.64](#)
- [Color Mode] button  [p.56](#)
- [☀] (illumination) button
- [Enter()] button  [p.25, p.92, p.95](#)
- [Menu] button  [p.92](#)
- [Preview] button  [p.38](#)
- [Preset] button  [p.68](#)
- [Wall Shot] button  [p.51](#)
- [Volume] buttons  [p.57](#)
- [Num] button  [p.59](#)



- [Power] button  [p.36, p.40](#)
- [R/C] switch  [p.12](#)
- [A/V Mute] button  [p.62](#)
- [Resize] button  [p.70](#)
- [Freeze] button  [p.63](#)
- [] button  [p.25, p.92, p.95](#)
- [Effect] button  [p.66](#)
- [ESC()] button  [p.25, p.93, p.95](#)
- [Help] button  [p.95](#)
- [Source] buttons  [p.37](#)
- [Auto] button  [p.53](#)
- Numeric buttons  [p.59, p.74](#)
- [ID] button  [p.74](#)
- [Remote] port  [p.13](#)



Control Panel

Buttons with no description are the same as the remote control buttons. Refer to the remote control descriptions for details.

- **[Auto/Enter] button** [p.53](#), [p.92](#), [p.95](#)

Works the same as the [Auto] button on the remote control.

When pressed while a configuration menu or help menu is being displayed, it works the same as the [Enter] button on the remote control.

- **[▲] and [▼] buttons** [p.55](#), [p.92](#), [p.95](#)

Use these buttons for vertical keystone correction and correction using Quick Corner.

If you press one of these buttons while holding down the [Shift] button, you can adjust the [sync](#) of computer images.

- **[◀] and [▶] buttons** [p.54](#), [p.93](#), [p.95](#)

Use these buttons for horizontal keystone correction and correction using Quick Corner.

If you press one of these buttons while holding down the [Shift] button, you can adjust the [tracking](#) of computer images.

When pressed while a configuration menu or help menu is being displayed, these buttons function as [◀] and [▶] (left and right) buttons for selecting items in the menu.

- **[Menu] button** [p.92](#)

- **[Power] button** [p.36](#), [p.40](#)

- **[Source] buttons** [p.37](#)

[Computer/DVI] button:

Switches the input source between the [Computer] port, [DVI] port and [EasyMP] in that order each time the button is pressed.

[Video/BNC] button:

Switches the input source between the [S-Video] port, [Video] port and the [BNC] ports in that order each time the button is pressed.

- **[Wall Shot] button** [p.51](#)

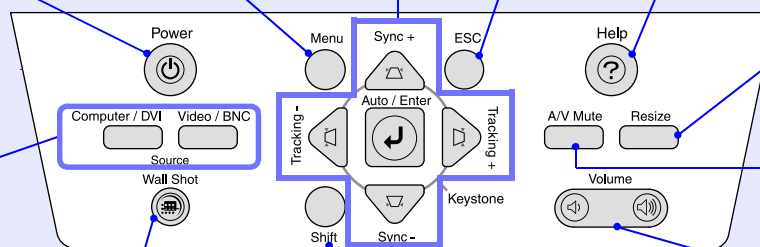

- **[ESC] button** [p.93](#), [p.95](#)

- **[Help] button** [p.95](#)

- **[Resize] button** [p.70](#)

- **[A/V Mute] button** [p.62](#)

- **[Volume] button** [p.57](#)

- **[Shift] button** [p.54](#), [p.55](#), [p.72](#)

This button has no function by itself, but is used when adjusting the sync and tracking and when using the resize function.



Part Names and Functions

Input/Output Ports

-
- [Monitor Out] port** [p.26](#)
 Outputs analogue-RGB signals from a computer connected to the projector by a computer cable, to an external monitor. It is not compatible with digital-RGB signals from computers, video images and EasyMP images.
 - Access Lamp**
EasyMP Setup Guide, EasyMP Operation Guide
 The access status of a memory card inserted in the PC card slot is indicated by coloured lights that may be on or off.
 - Eject button** [p.16](#)
 Press this button to eject a PC card when it has been inserted into the card slot.
 - Card Slot** [p.16](#)
 Insert a wireless LAN card, wired LAN card, or memory card into the slot when using EasyMP.
 - [Audio Out] port** [p.32](#)
 Outputs the audio signals from the selected video source to external speakers.
 - [Remote] port**
[p.129](#)
 Connect the optional remote control cable set to input signals from the remote control.
 - [Video] port** [p.27](#)
 Inputs [composite video](#) signals from a video source.
 - [Audio] ports (for [Video] port)** [p.31](#)
 Input audio signals from the source that is connected to the [Video] port.
 - [S-Video] port** [p.28](#)
 Inputs [S-Video](#) signals from a video source.
 - [Audio] ports (for [S-Video] port)** [p.31](#)
 Input audio signals from the source that is connected to the [S-Video] port.
 - [USB TypeA] port** [p.33](#)
 Connects a digital camera to the projector when projecting digital camera image files with EasyMP.
 - [USB TypeB] port** [p.24, p.134](#)
 When the projector is connected to a computer with a computer cable, use this port to connect a USB cable to the computer to use the wireless mouse function.
 - [Control (RS-232C)] port** [p.134](#)
 Connects the projector to a computer using an RS-232C cable. This port is for control use and should not be used by the customer.
 - [Computer] port**
[p.19, p.23, p.29](#)
 Inputs analogue-RGB signals from a computer and RGB-video signals from video equipment.
 - [DVI] port** [p.22, p.23](#)
 Inputs digital RGB computer video signals.
 - [Audio] port (for [Computer], [DVI] port)** [p.31](#)
 Inputs audio signals from the equipment connected to the [Computer] port or the [DVI] port.
 - [BNC] ports** [p.22, p.23, p.28](#)
 Inputs analogue-RGB signals from a computer and RGB-video signals and [component video](#) signals from video equipment.
 - [Audio] ports (for [BNC] port)** [p.31](#)
 Input audio signals from the source that is connected to the [BNC] ports.



Before Using the Remote Control

Inserting the Batteries

The batteries are not already inserted into the remote control at the time the projector is purchased. You will need to insert the batteries that are provided with the projector before the remote control can be used.



CAUTION

Be sure to read the Safety Instructions/World-Wide Warranty Terms before handling the batteries.

PROCEDURE

1 Remove the battery cover.

While pushing down on the rib of the battery cover, slide the battery cover in the direction of the arrow.

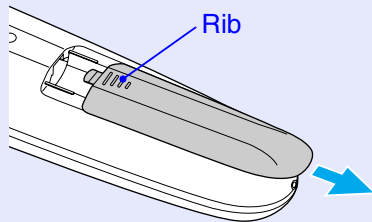
**2**

Insert the batteries.

Check the positions of the (+) and (-) marks inside the battery holder to ensure that the batteries are inserted the correct way.

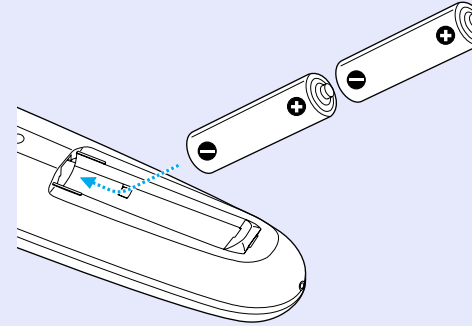
**3**

Replace the battery cover.

Slide the battery cover in until the tab clicks into place.

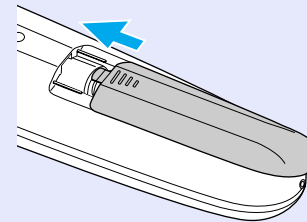

TIP

If delays in the responsiveness of the remote control occur or if it does not operate after it has been used for some time, it probably means that the batteries are becoming flat. If this happens, replace the batteries with two new AA alkali batteries.



Using the Remote Control and Remote Operating Range

Using the Remote Control

The remote control is used in the following way.

PROCEDURE

- 1 Set the [R/C] switch of the remote control to "ON".

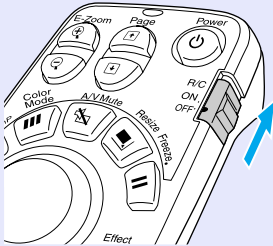

- 2 Point the remote control light-emitting area towards one of the remote control light-receiving areas on the projector and operate the remote control buttons.

Remote control light-receiving area (front)

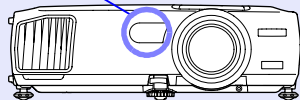

Remote control light-receiving area (rear)



Remote control light-emitting area



TIP

- Do not allow sunlight or light from fluorescent lamps to shine directly onto the projector's remote control light-receiving areas, otherwise it may interfere with the reception of signals from the remote control.
- When not using the remote control, set the [R/C] switch on the remote control to "OFF". If you leave the [R/C] switch at "ON", it will consume battery power.
- If a button on the remote control is pressed down for more than 1 minute while the [R/C] switch is at "ON", the signal for that button operation will stop being transmitted (the remote control will change to sleep mode). The purpose of this is to prevent the batteries from being consumed due to something being placed on top of the remote control. When the button is released, normal remote control operation will resume.



Before Using the Remote Control

Remote Operating Range

Use the remote control within the ranges indicated below. If the distance or angle between the remote control and the remote control light-receiving area is outside the normal operating range, the remote control may not work.

Operating distance	Operating angle
Approx. 10 m (30 ft.)	Approx. $\pm 30^\circ$ horizontally Approx. $\pm 15^\circ$ vertically

Operating angle (horizontal)

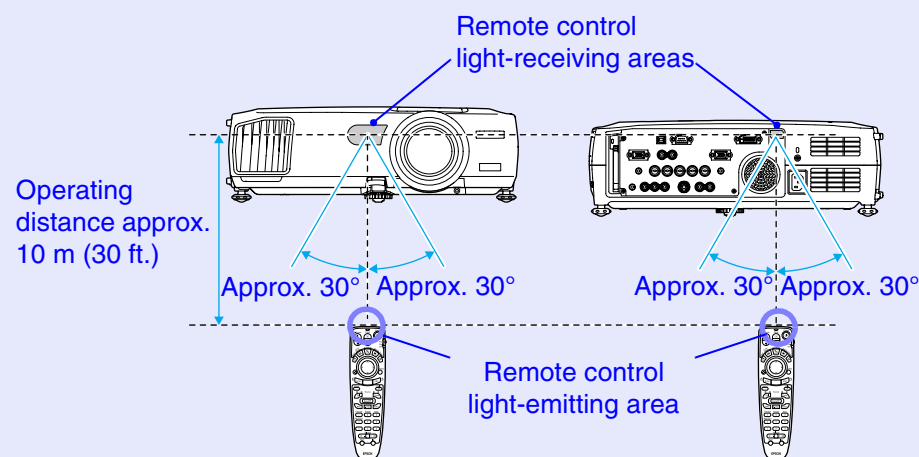

Operating angle (vertical)

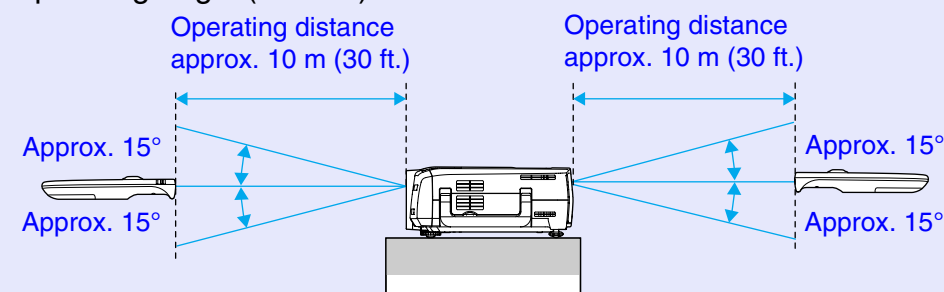

When suspended from the ceiling

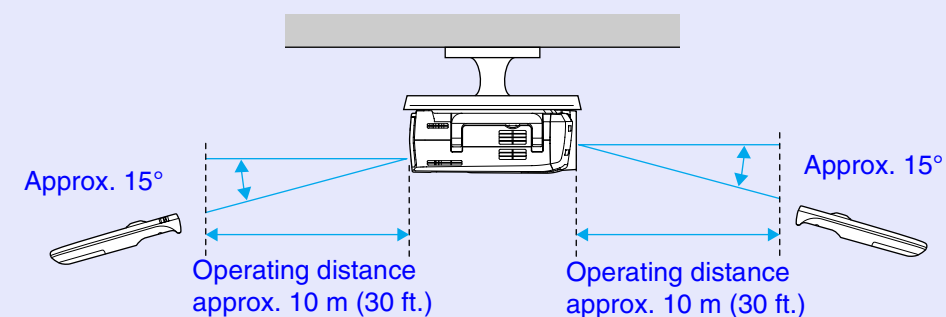

TIP

If you would like to ensure that remote control operations work properly from a distance, use the optional remote control cable set to connect the [Remote] port of the remote control to the projector's [Remote] port.

See "Appendices: Optional Accessories" p.129



Installation

Setting Up the Projector

The projector supports the following four different projection methods, allowing you to choose the best method for displaying your images.



CAUTION

Before setting up the projector, be sure to first read the separate Safety Instructions/World-Wide Warranty Terms.

• Front projection

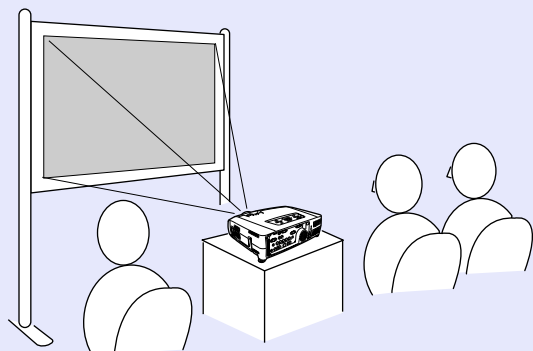

• Rear projection using a translucent screen

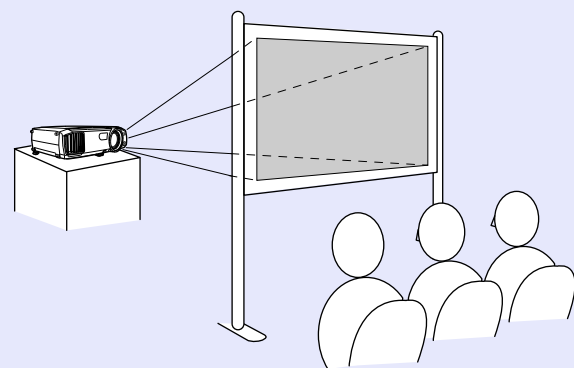

• Front/ceiling projection

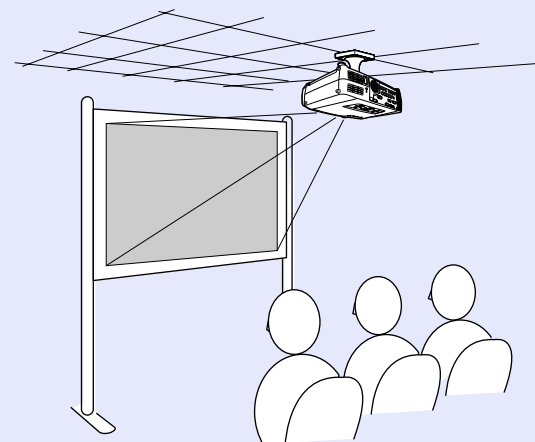

• Rear/ceiling projection using a translucent screen

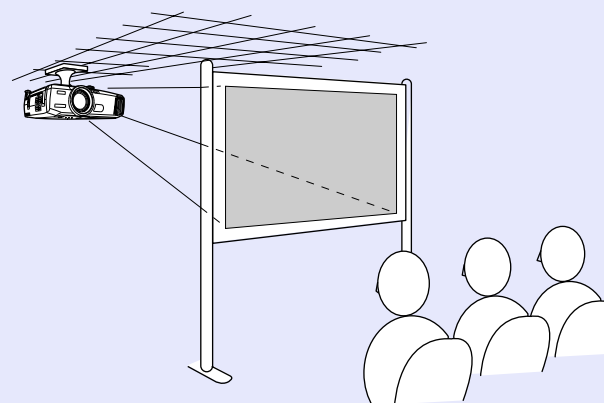

* A special method of installation is required for suspending the projector from the ceiling. Please contact your supplier if you would like to use this installation method. The optional ceiling mount is required when installing the projector on the ceiling.

☞ p.129



TIP

When using rear/ceiling projection using a translucent screen, set the "Ceiling" and "Rear Proj." commands in the "Advanced1" menu to match the installation method. ☞ p.87



Screen Size and Projection Distance

The distance from the lens to the screen determines the actual image size. The recommended distance and projection distance values given below are for when the projector is fitted with a standard lens. If the projector has been fitted with an optional lens, refer to the documentation provided with the lens.

Recommended distance	77–1113 cm (2.5–36.5 ft.)
-----------------------------	---------------------------

While referring to the following table, position the projector so that the images are projected onto the screen at the optimum size. The values should be used as a guide for setting up the projector. The actual values will vary depending on projection conditions and the zoom setting.

4:3 screen size (cm (in.))	Projection distance (cm (ft.))
30" (61 × 46 (24.0 × 18.1))	77–107 (2.5–3.5)
40" (81 × 61 (31.9 × 24.0))	105–144 (3.5–4.7)
60" (120 × 90 (47.2 × 35.4))	161–219 (5.3–7.2)
80" (160 × 120 (63.0 × 47.2))	216–293 (7.1–9.6)
100" (200 × 150 (78.7 × 59.1))	272–368 (8.9–12.1)
200" (410 × 300 (161.4 × 118.1))	550–740 (18.0–24.3)
300" (610 × 460 (240.2 × 181.1))	827–1113 (27.1–36.5)

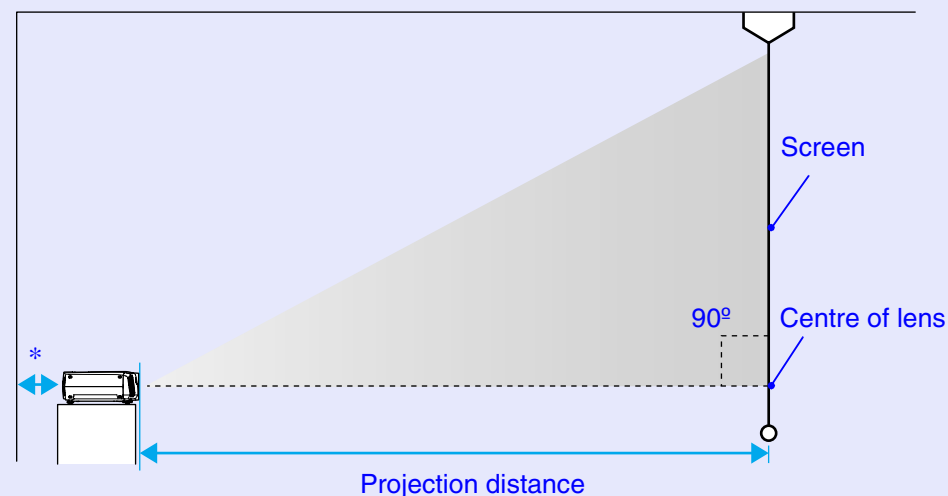

* When installing against a wall, leave a space of 20 cm (7.9 in.) or more between the projector and the wall.



TIP

The standard lens allows a zoom ratio of up to about 1.35. The image size at the maximum zoom setting is about 1.35 times bigger than the image size at the minimum zoom setting.

- *When keystone correction is carried out, the projected images will become smaller. Use the zoom function to adjust the size of the images if necessary. [p.42](#)*



Inserting and Removing Cards

Inserting and removing PC cards will be explained using the included wireless LAN card provided as an example. When using other cards, or inserting or removing a card in a PC card slot on a computer, refer to the documentation included with the card.



TIP

The following PC cards can be inserted in the card slot on this projector.

- *Wireless LAN card (only compatible with the included accessory)*
- *Memory card*
- *Wired LAN card*

For details on compatible wired LAN cards see "Compatible PC Cards" in the EasyMP Setup Guide

Installation



- *Insert the PC card facing the right way. Installing the device back to front or upside down may cause failure or damage.*
- *Always remove the card before transporting the projector.*

PROCEDURE

Hold the wireless LAN card with the face outward and insert it into the projector card slot.

Insert firmly into the slot until it is secure. Once the wireless LAN card has been fully inserted in the card slot, the rear edge of the card will protrude from the slot.

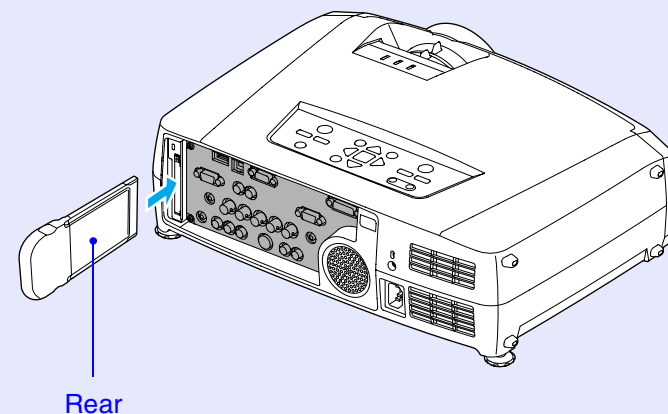



Removal

CAUTION

- Do not remove a PC card when the access lamp is lit green, when connected to a network or when projecting a scenario. Improperly removing a PC card may result in damage to the card or data destruction on a memory card.
- The PC card gets hot during and after projector use. Please handle the card carefully to avoid personal injury or burns.
- When you wish to remove a memory card whilst using CardPlayer, be sure to close CardPlayer before removal. CardPlayer may malfunction if a memory card is removed without closing CardPlayer first. ➔ ["Closing CardPlayer"](#) in the EasyMP Operation Guide

PROCEDURE

- 1 Press the eject button above the card slot.
The eject button will pop out.

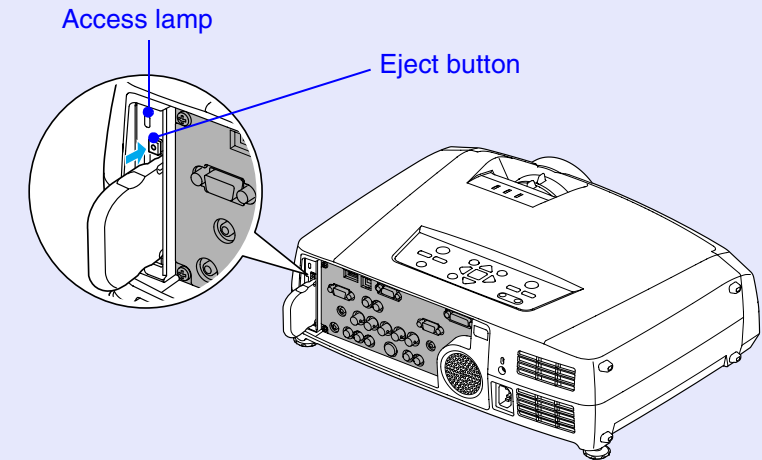

- 2 Press the eject button again.
Enough of the wireless LAN card will be ejected so that you can grasp the edge of the card and pull it straight out of the slot.

CAUTION

Be sure to press the eject button back in to prevent it from being broken or damaged.



Connecting to a Computer

CAUTION

When connecting the projector to a computer, be sure to check the following.

- *Turn the power off for both the projector and the computer before connecting them. If the power for either device is on at the time of connection, damage may result.*
- *Check the shapes of the cable connectors and the device ports before making the connections. If you try to force a connector to fit a device port with a different shape or number of terminals, a malfunction or damage to the connector or port may result.*
- *Do not bind the power cable and the connecting cable together. If the power cable and the connecting cable are bound together, image interference or errors in operation may result.*

- Condition 2: The display resolution and frequency of the computer must be listed in the "List of Supported Monitor Displays".  [p.136](#)
Some computers allow you to change the output resolution, so if necessary, change the resolution to one that matches a setting in the "List of Supported Monitor Displays". Refer to the documentation provided with the computer.

TIP

- *You may need to purchase a commercially-available adapter depending on the shape of the computer's port. Refer to the documentation provided with the computer for further details.*
- *If the computer and projector are too far away from each other for the accessory computer cable to reach, use the optional VGA-HD15 PC cable. See  "Appendices: Optional Accessories" [p.129](#)*

Eligible Computers

The method for connecting the projector to a computer using a cable is explained here. Refer to the *EasyMP Setup Guide* when connecting to a computer via a network.

The projector cannot be connected to some types of computer, or projection of images may not be possible even if actual connection is possible. Make sure that the computer you intend to use satisfies the conditions given below.

- Condition 1: The computer must have an image signal output port. Check that the computer has a port such as an "RGB port", "monitor port" or "CRT port" which can output image signals.
If the computer has a built-in monitor, or if using a laptop computer, it may not be possible to connect the computer to the projector, or alternatively you may need to purchase a separate external output port. Refer to the documentation for your computer under a heading such as "Connecting an external monitor" or similar for further details.



Projecting Images from the Computer

The shape and specifications of the computer's monitor port will determine what type of cable should be used. Check the following to see which type of port your computer has.

■ If the Monitor Port is a Mini D-Sub 15-pin Port

Use the accessory computer cable to make the connections.

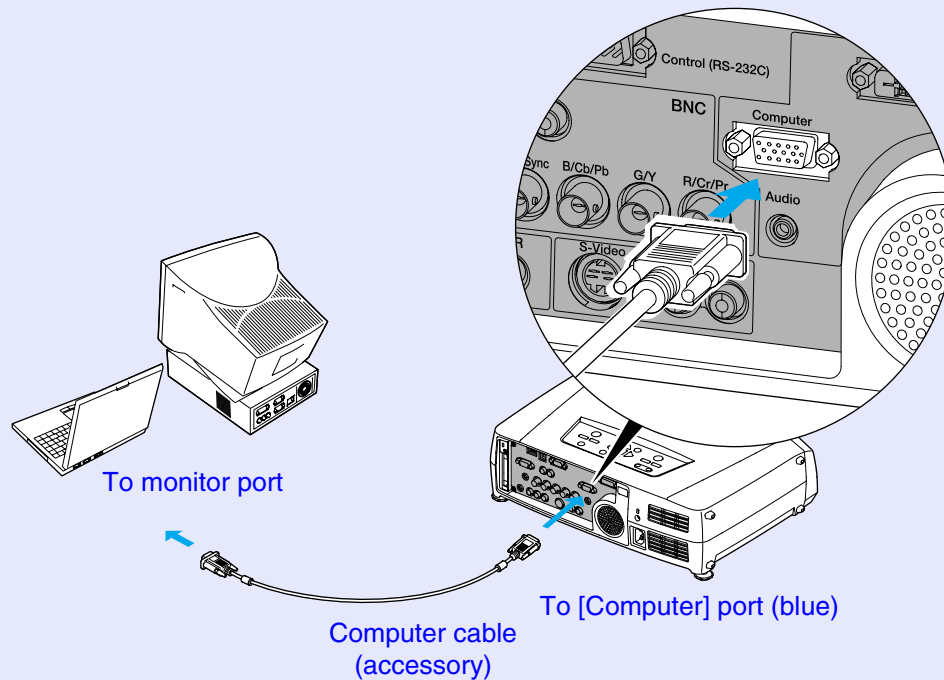

TIP

- After projection starts, change the "Computer Input" setting in the "Setting" menu to "Analog-RGB". ➔ p.84
- If more than one external component is connected to the projector, press the [Comp] button on the remote control after projection starts, or repeatedly press the [Computer/DVI] button on the projector's control panel until "Computer (Analog-RGB)" is displayed on the projected image to select the signal to be projected. ➔ p.37



■ If the Monitor Port is a 13w3 Port

Some workstation-type computers have a 13w3 monitor port.

In such cases, use a commercially-available 13w3 ↔ D-Sub 15-pin cable to make the connection.

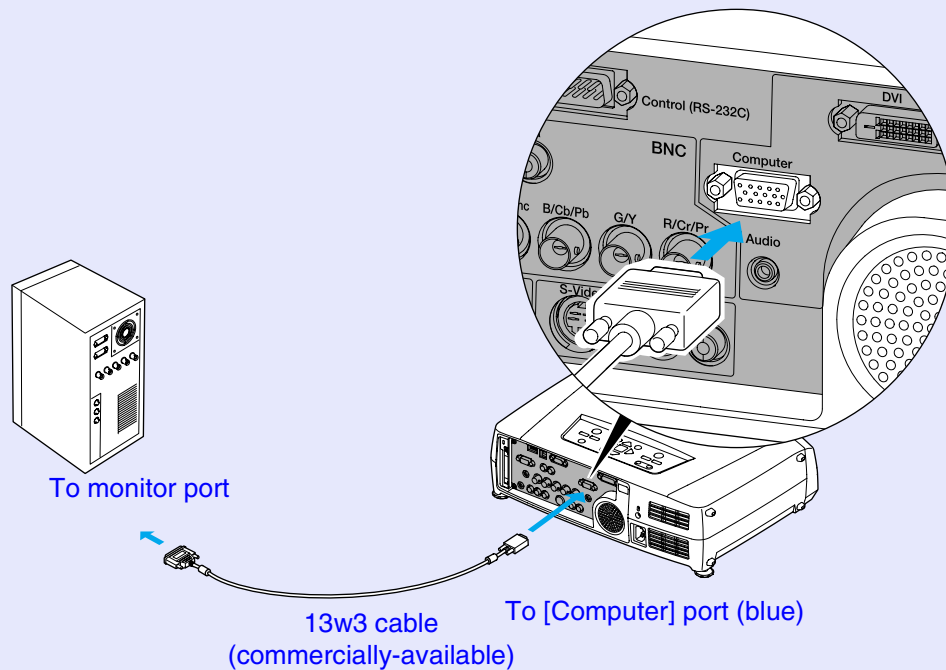

TIP

- After projection starts, change the "Computer Input" setting in the "Setting" menu to "Analog-RGB". [☛ p.84](#)
- If more than one external component is connected to the projector, press the [Comp] button on the remote control after projection starts, or repeatedly press the [Computer/DVI] button on the projector's control panel until "Computer (Analog-RGB)" is displayed on the projected image to select the signal to be projected. [☛ p.37](#)
- Some workstations may require a special cable. Consult the workstation manufacturer for further details.



■ If the Monitor Ports are a 5BNC Ports

Either of the following two connection methods can be used depending on the connection ports or the type of cable being used.

- Use the optional VGA-HD15/BNC PC cable to connect the monitor port of the computer to the [Computer] port at the rear of the projector.
- See "Appendices: Optional Accessories" p.129
- Use a commercially-available 5BNC monitor cable ([5BNC](#) /male-male) to connect the monitor ports of the computer to the [BNC] port at the rear of the projector.

If connecting to the [Computer] port

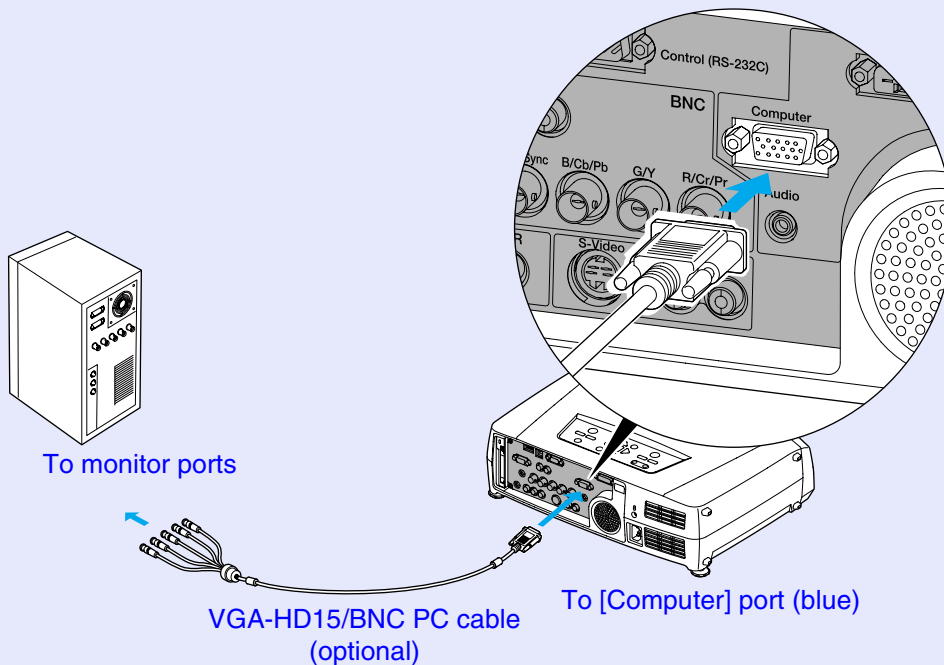

TIP

- After projection starts, change the "Computer Input" setting in the "Setting" menu to "Analog-RGB". p.84
- If more than one external component is connected to the projector, press the [Comp] button on the remote control after projection starts, or repeatedly press the [Computer/DVI] button on the projector's control panel until "Computer (Analog-RGB)" is displayed on the projected image to select the signal to be projected. p.37





If connecting to the [BNC] ports

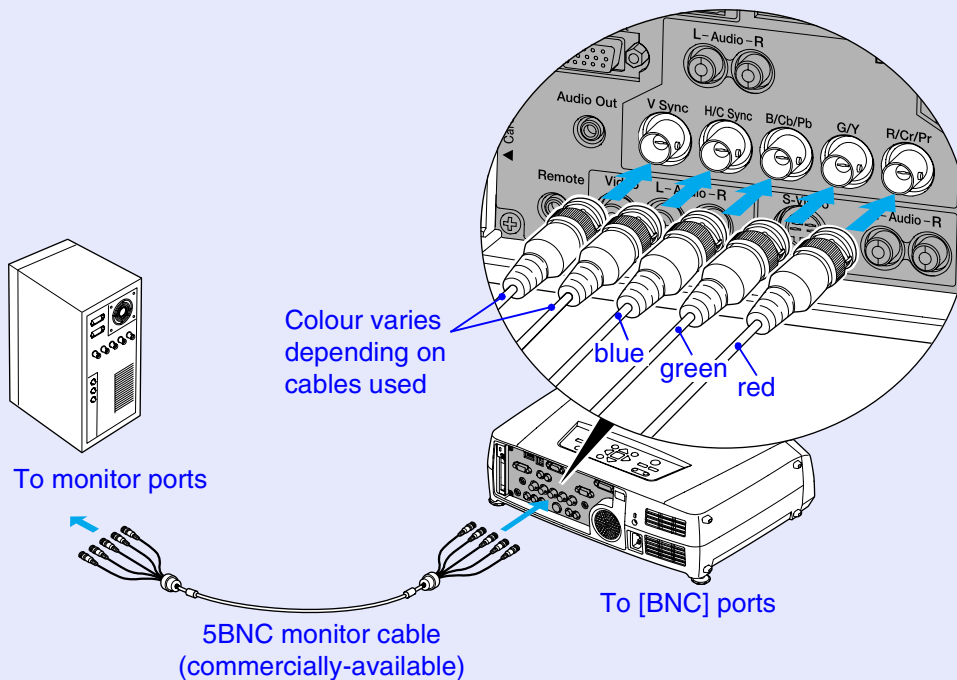

TIP

- After projection starts, change the "BNC Input" setting in the "Setting" menu to "Analog-RGB". [p.84](#)
- If more than one external component is connected to the projector, press the [BNC] button on the remote control after projection starts, or repeatedly press the [Video/BNC] button on the projector's control panel until "BNC (Analog-RGB)" is displayed on the projected image to select the signal to be projected. [p.37](#)

■ If the Monitor Port is a Digital RGB Port

Use the optional [DVI](#) -D/DVI-D digital video cable or DVI-D/DFP digital video cable to make the connection.

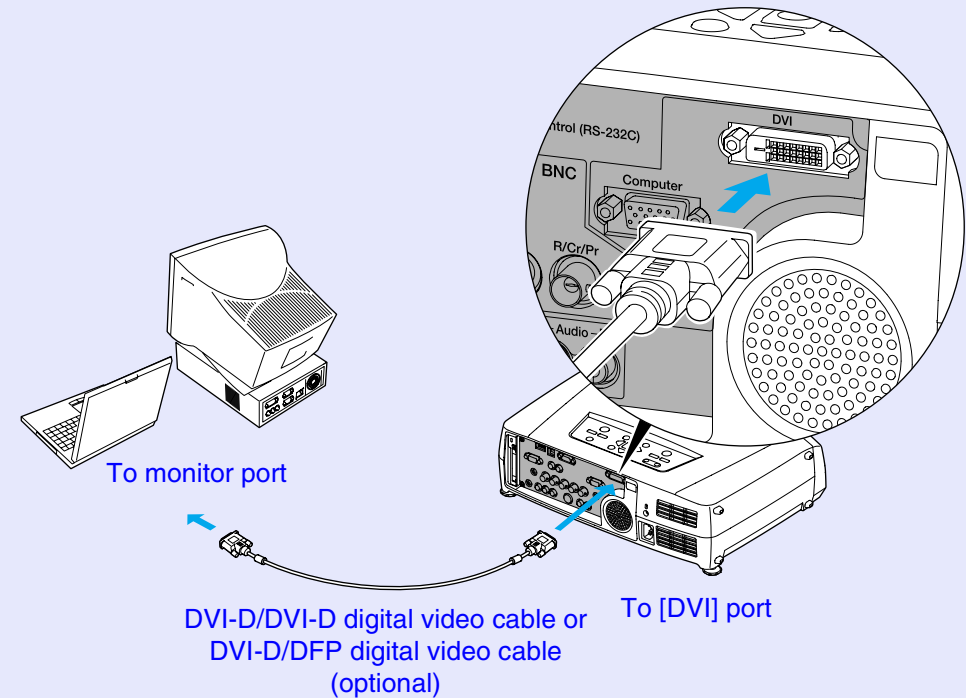

TIP

- Use whichever optional DVI-D/DVI-D digital video cable or DVI-D/DFP digital video cable matches the monitor port of the computer. See "Appendices: Optional Accessories" [p.129](#)
- If more than one external component is connected to the projector, press the [DVI] button on the remote control after projection starts, or repeatedly press the [Computer/DVI] button on the projector's control panel until "DVI" is displayed on the projected image to select the signal to be projected. [p.37](#)





If Connecting More Than One Computer

The ports shown below can be used to connect computers to the projector. If computers are connected to all of the ports shown below, a maximum of three computers can be connected.

Connection details [p.18–p.22](#)

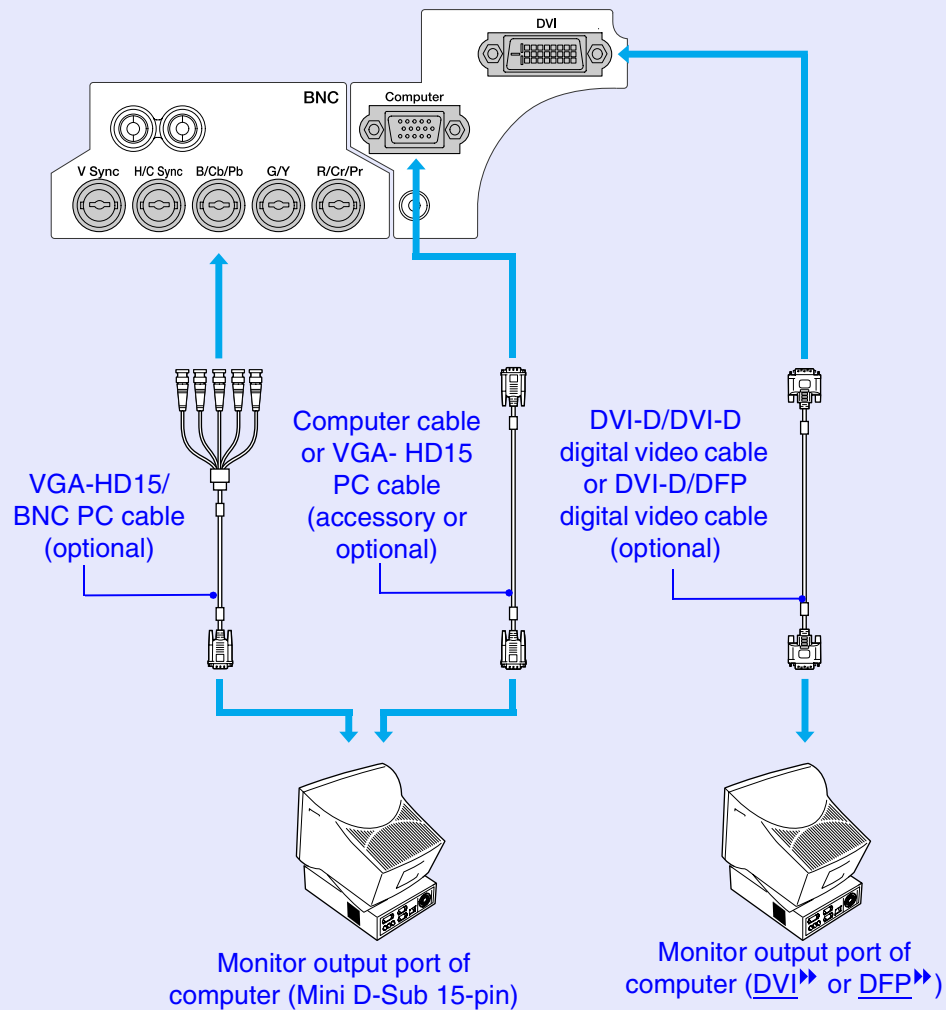



Using the Remote Control to Operate the Mouse Pointer (Wireless Mouse Function)

You can use the remote control as a wireless mouse to control the mouse pointer on the screen by using the accessory **USB** cable to connect the USB port of the computer to the [USB TypeB] port at the rear of the projector.

Computer	Mouse used	Applicable cable
Windows 98/2000/Me/ XP Home Edition/XP Professional	USB mouse	USB cable (accessory)
Macintosh (OS 8.6–9.2/10.0–10.2)	USB mouse	USB cable (accessory)

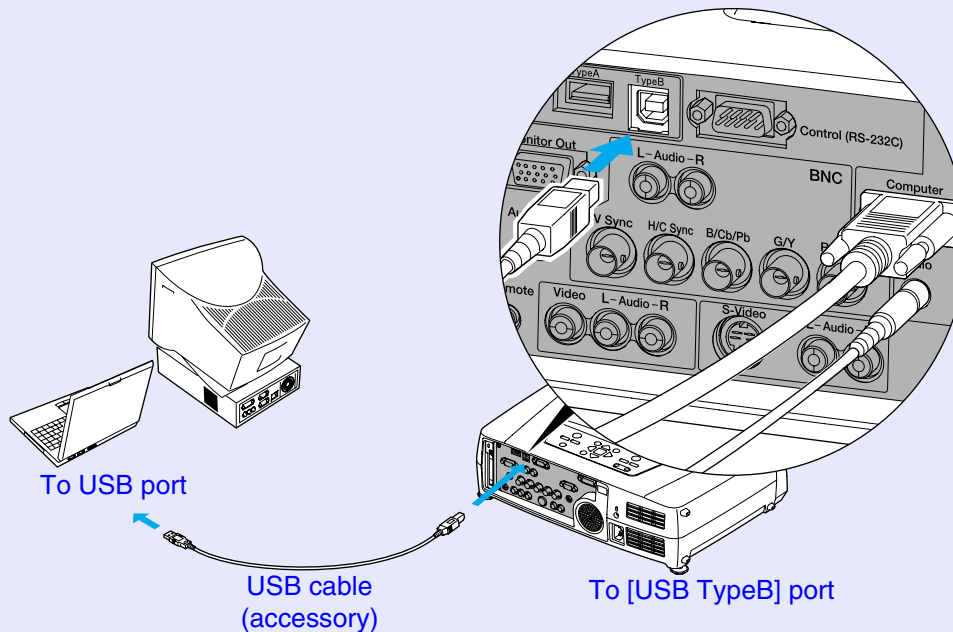

TIP

- **The USB cable can only be connected to computers with a standard USB interface. If using a computer which is running Windows, the computer must have had a full version of Windows 98/2000/Me/XP Home Edition/XP Professional installed. If the computer is running a version of Windows 98/2000/Me/XP Home Edition/XP Professional that has been upgraded from an earlier version of Windows, correct operation cannot be guaranteed.**
- **It may not be possible to use the wireless mouse function under some versions of both the Windows and Macintosh operating systems.**
- **Some computer settings may have to be changed in order for the mouse function to be used. Consult the documentation for the computer for further details.**
- **The [USB TypeA] port on the back of the projector does not function as a USB hub.**

* When using the remote control as a wireless mouse, the [Page ↓] and [Page ↑] buttons on the remote control can be used to scroll back and forth through slides when projecting a PowerPoint presentation.





Once the connection has been made, the mouse pointer can be operated as follows.

Moving the mouse pointer

Tilt the [○] button on the remote control to move the mouse pointer in the direction of tilt.

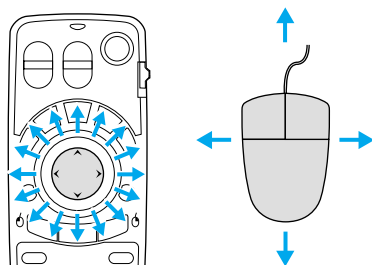

Left click

Press the [Enter (♣)] button.
If you press the [Enter (♣)] button twice in rapid succession, it has the effect of a double-click.

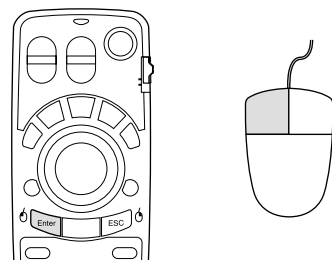

Right click

Press the [ESC (♣)] button.

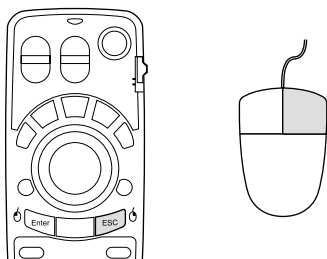

Drag and drop

When you hold down the [Enter (♣)] button for approximately 1.5 seconds, the button will light and drag and drop mode will be enabled. In this mode, you can carry out drag operations by tilting the [○] button.
Press the [Enter (♣)] button at the desired position to drop the items being dragged.

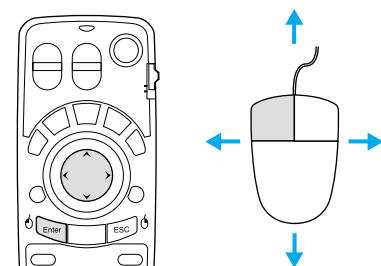

Drag and drop mode can also be enabled in the same way by pressing the [ESC (♣)] button for approximately 1.5 seconds. This operation allows right click dragging and dropping.



TIP

- *If the mouse button settings have been reversed at the computer, the operation of the remote control buttons will also be reversed.*
- *The wireless mouse function of the remote control cannot be used while the following functions are being used.*
 - *While a configuration menu is being displayed*
 - *While a help menu is being displayed*
 - *While the Effect function is being used*
 - *While a sub-screen has been set using the P in P function*
 - *While the E-Zoom function is being used*
 - *While a Quick Corner setting has been made*
 - *While a window is being displayed in real mode using the resize function*
 - *While the Preview function is being used*
 - *While a user's logo is being captured*
 - *While Wall Shot is enabled*





Connecting an External Monitor

When analogue RGB signals from a computer connected by a computer cable are being projected, you can connect an external monitor to the projector in order to view the images on the external monitor at times such as when giving presentations.

Connect the external monitor using the cable that is provided with the monitor.

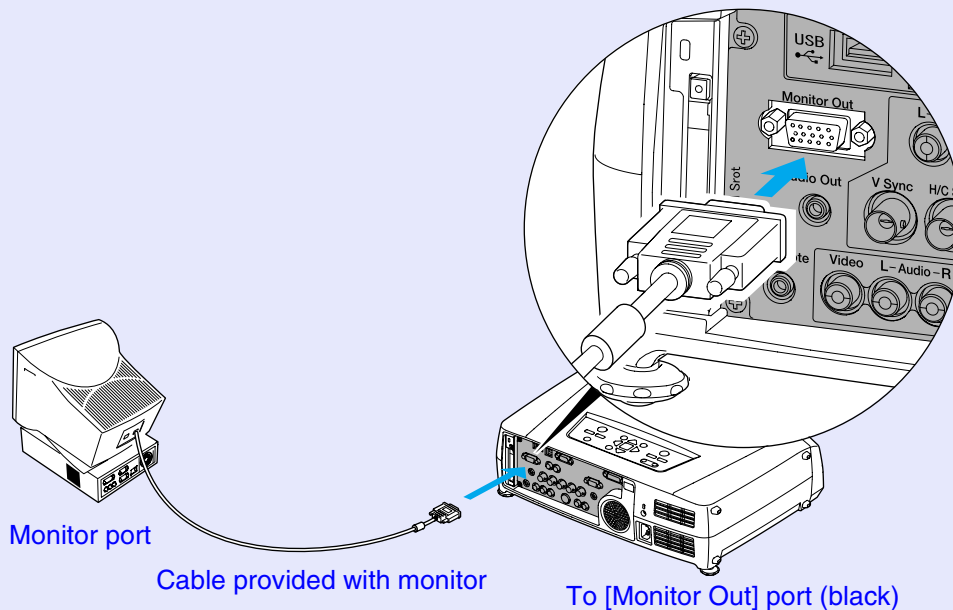

TIP

- *Digital RGB images from a computer, video images and EasyMP images cannot be output to an external monitor.*
- *The setting gauge for keystone correction and the configuration menus and help menus are not output to the external monitor.*



Connecting to a Video Source

! CAUTION

When connecting the projector to other video sources, take the following precautions.

- Turn the power off for both the projector and the video source before connecting them. If the power for either device is on at the time of connection, damage may result.
- Check the shapes of the cable connectors and the device ports before making the connections. If you try to force a connector to fit a device port with a different shape or number of terminals, damage to the connector or port may result.
- Do not bind the power cable and the connecting cable together. If the power cable and the connecting cable are bound together, image interference or errors in operation may result.

Projecting Composite Video Images

Use the accessory RCA video cable to make the connections.

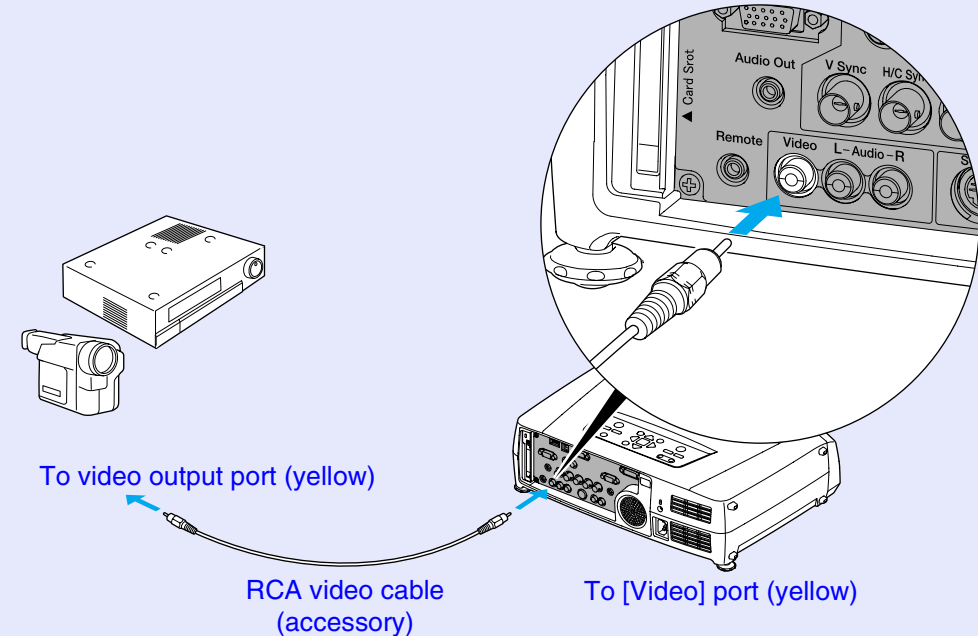

👉 TIP

If more than one external component is connected to the projector, press the [Video] button on the remote control after projection starts, or repeatedly press the [Video/BNC] button on the projector's control panel until "Video" is displayed on the projected image to select the signal to be projected. ➡ p.37



Projecting S-Video Images

Use a commercially-available [S-Video](#) cable to make the connections.

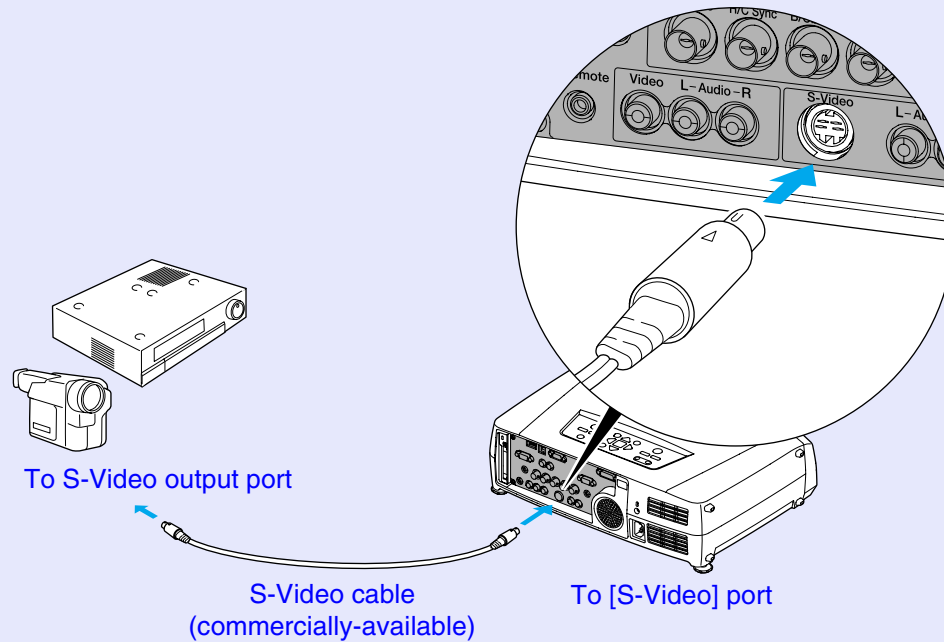

TIP

If more than one external component is connected to the projector, press the [S-Video] button on the remote control after projection starts, or repeatedly press the [Video/BNC] button on the projector's control panel until "S-Video" is displayed on the projected image to select the signal to be projected. ➔ p.37

Projecting Component Video Images

Use a commercially-available [component video](#) cable and three conversion adapters to make the connections.

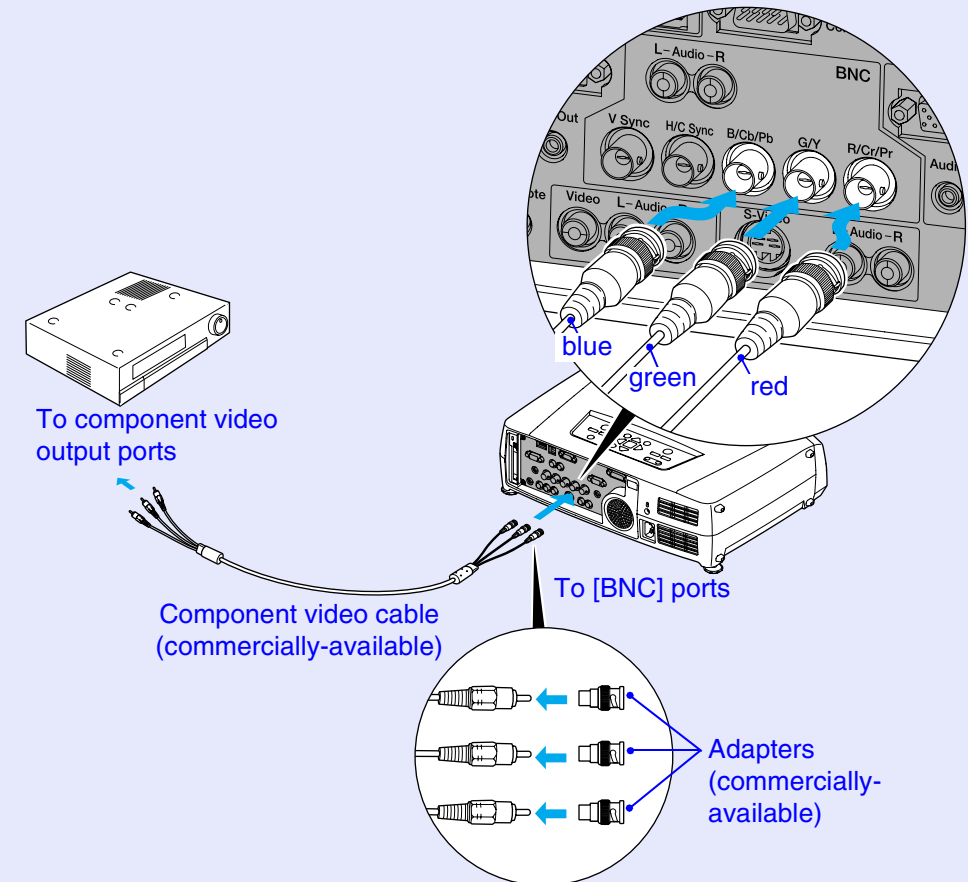



TIP

- After projection starts, change the "BNC Input" setting in the "Setting" menu to either "YCbCr" or "YPbPr" to match the signals from the video equipment. [p.84](#)
- If more than one external component is connected to the projector, press the [BNC] button on the remote control after projection starts, or repeatedly press the [Video/BNC] button on the projector's control panel until "BNC (YCbCr)" or "BNC (YPbPr)" is displayed on the projected image to select the signal to be projected. [p.37](#)

Projecting RGB Video Images

RGB video is used when projecting RGB signals from a video source other than a computer that is connected to the projector. Either of the following two connection methods can be used. Use whichever method is suitable for the video equipment's port.

■ If the RGB Output Port is a Mini D-Sub 15-pin Port

Use the accessory computer cable to make the connections.

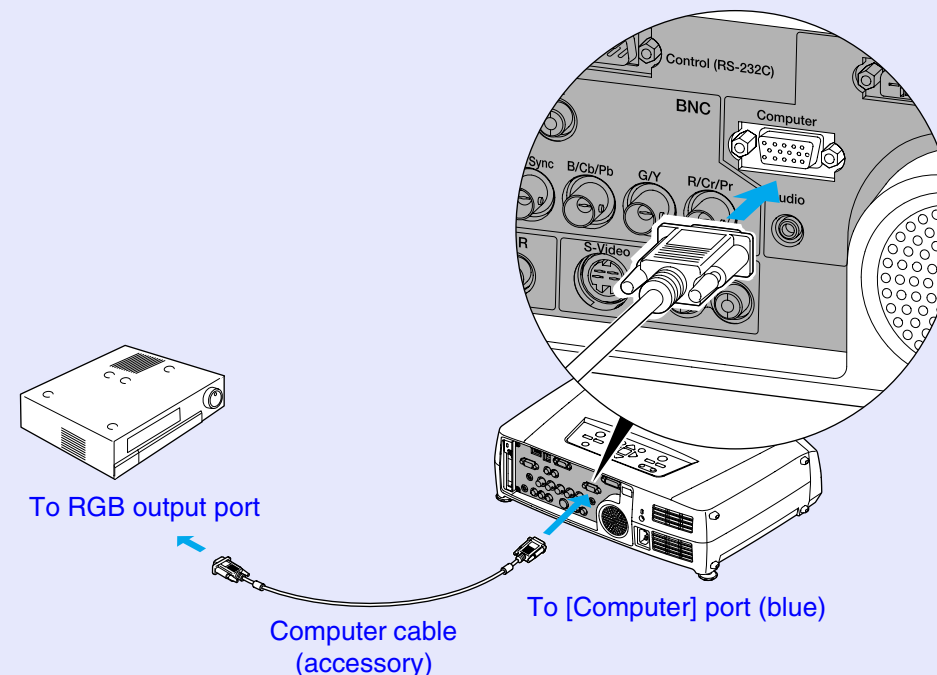

TIP

- After projection starts, change the "Computer Input" setting in the "Setting" menu to "RGB-Video". [p.84](#)
- If more than one external component is connected to the projector, press the [Comp] button on the remote control after projection starts, or repeatedly press the [Computer/DVI] button on the projector's control panel until "Computer (RGB-Video)" is displayed on the projected image to select the signal to be projected. [p.37](#)





Connecting to a Video Source

■ If the RGB Output Ports are the 3BNC Ports

Use a commercially-available RGB video cable to make the connections.

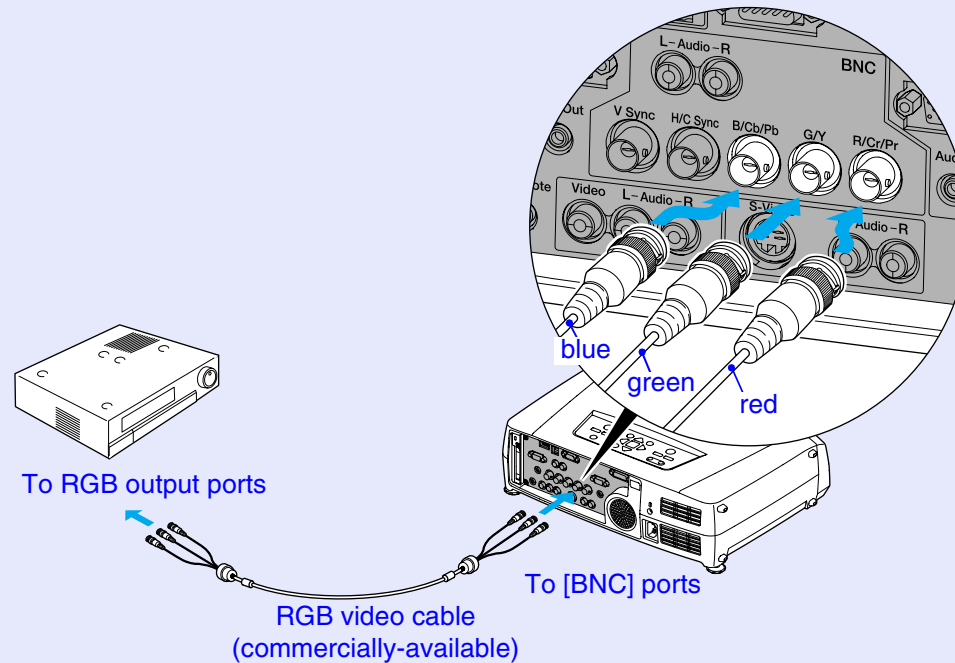

TIP

- After projection starts, change the "BNC Input" setting in the "Setting" menu to "RGB-Video". [p.84](#)
- If more than one external component is connected to the projector, press the [BNC] button on the remote control after projection starts, or repeatedly press the [Video/BNC] button on the projector's control panel until "BNC (RGB-Video)" is displayed on the projected image to select the signal to be projected. [p.37](#)



Playing Sound from the Video Equipment

The projector has a built-in speaker with a maximum output of 5 W. You can output sound from the connected video equipment (such as a computer or video deck) through the projector's built-in speaker if the video equipment has an audio output port.

In the case of the [DVI] and [Computer] ports, the [Audio] port to use is the port that is in the same box as the port being used to input the video signals. For other ports, the [Audio] port matches the port in the same box that is being used to input the video signals.

The audio cable to use for the connection can be either of the following, depending on the shape of the [Audio] port.

If the image signals are being input to the [Video] port

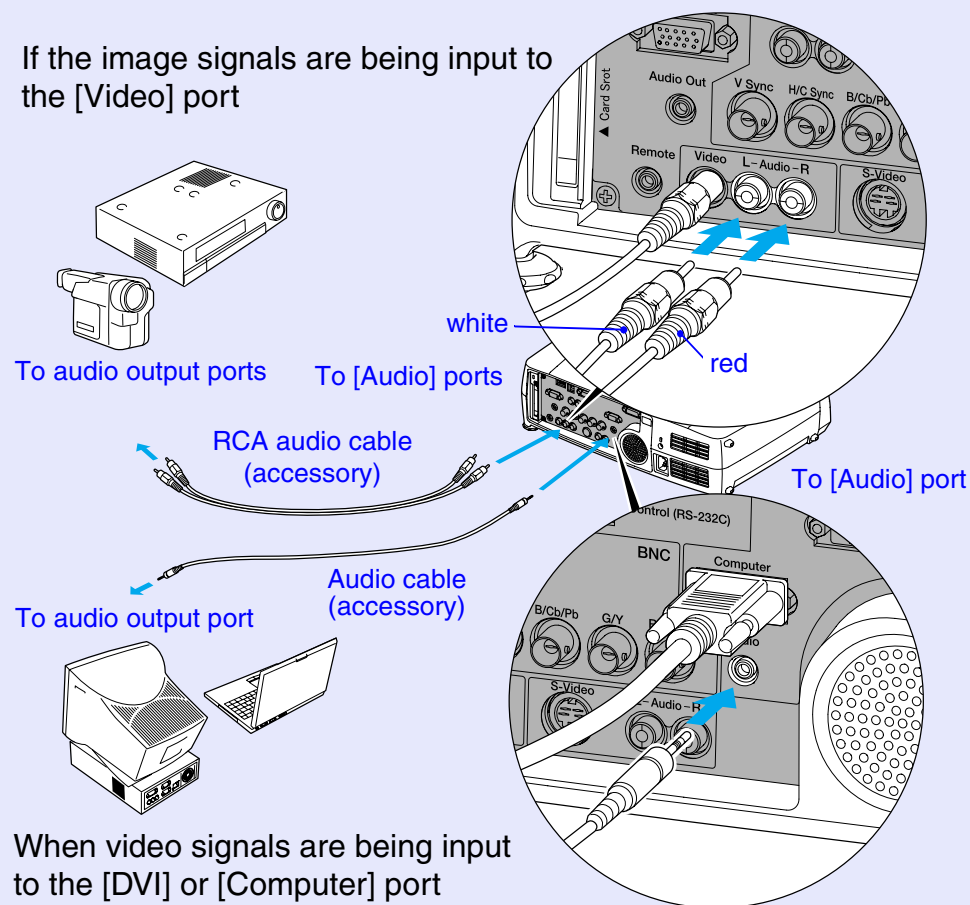

TIP

- You can adjust the volume after projection has started. [p.57](#)
- If the audio signal source is connected to the audio ports that are used in common with the [DVI] or [Computer] ports, the audio signals that are being input are output regardless of the image signal that is selected. The audio signals to be output using the "Computer/DVI Audio Input" setting in the "Audio" menu can only be set to "Computer" or "DVI".
- If using a commercially-available 2RCA (L/R)/stereo mini-jack audio cable, use one that is marked as "No resistance".



Playing Sound from External Speakers

You can connect speakers with built-in amplifiers to the projector's [Audio Out] port in order to enjoy a fuller quality of sound.

Use a commercially-available audio cable with pin jack ↔ stereo mini jack (3.5 mm) plugs or similar.

Use an audio cable with a plugs that match the ports for the external audio equipment.

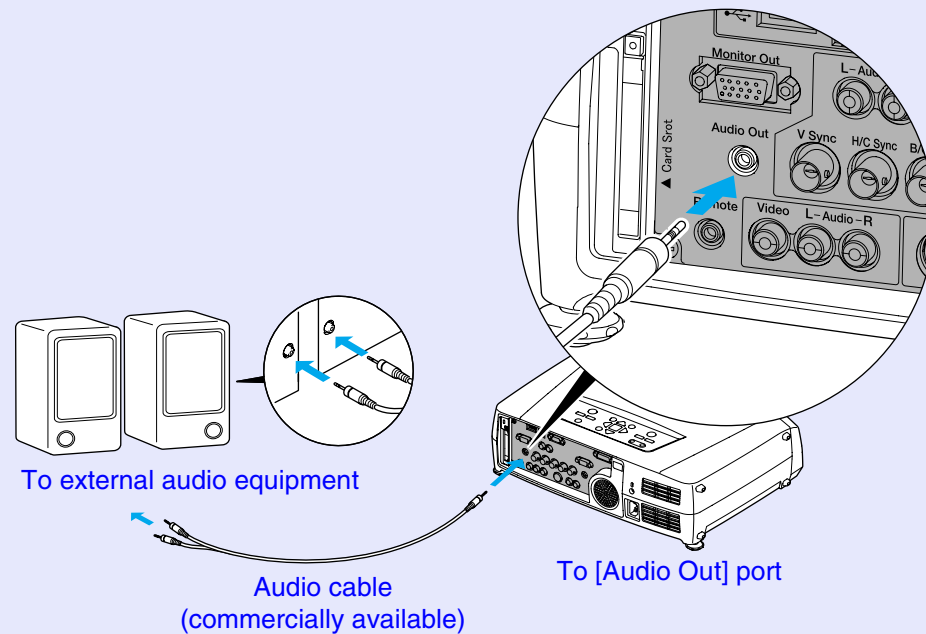

TIP

When a stereo mini-jack audio cable is inserted into the [Audio Out] port, the sound will be output to external speakers. No sound will be output from the projector's built-in speaker at this time.



Connecting to a Digital Camera

Connecting to a Digital Camera Using a USB Cable

Connect a digital camera to the projector using a USB cable provided with, or specified for use with your digital camera.



TIP

- Use a USB cable less than 3m in length. If the cable exceeds 3m, CardPlayer may not function correctly.
- Before connecting, ensure that a memory card or (wired or wireless) LAN card has not been set into the card slot of the projector.

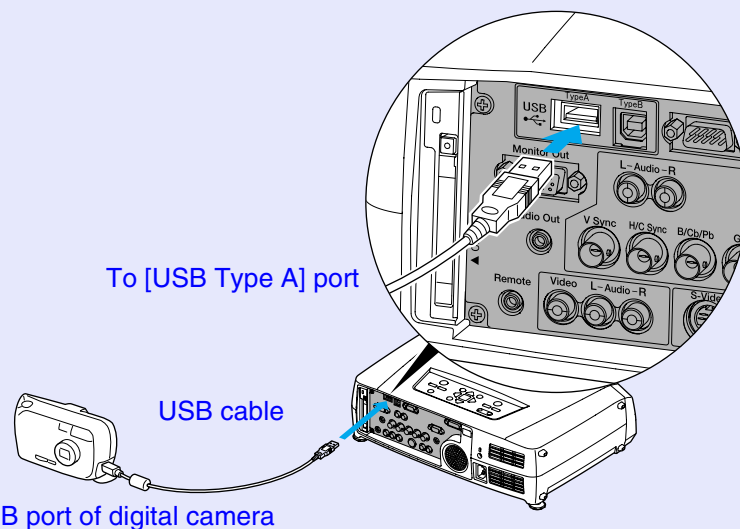

CAUTION

Projection may not be possible if using a USB hub. Please connect the digital camera directly to the projector. Do not use a hub.

Removing the USB Cable from the Projector

When you have finished projecting remove the USB cable from the projector in the following way.

PROCEDURE

- 1 Position the cursor with the "EJECT" button on the CardPlayer screen and press the [Enter] button on the remote control to close CardPlayer. ➔ **"Closing CardPlayer"** in the *EasyMP Operation Guide*

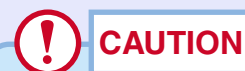

CAUTION

Be sure to shut down CardPlayer before removing the USB cable from the projector. CardPlayer may not operate correctly if the USB cable is removed before CardPlayer has shut down.

- 2 Remove the USB cable from the projector's [USB TypeA] port.



Basic Operations

This chapter describes basic operations such as turning projection on and off and adjusting the projected images.

Turning the Projector On.....	35	Adjusting the Image Quality.....	51
• Connecting the Power Cable	35	• Projecting Easy-to-see Images Without a Screen (Wall Shot).....	51
• Turning the Power On and Projecting Images	36	• Adjusting Computer Images	53
• Selecting an Image Source While Viewing Projected Images (Preview Function)	38	• Automatic Setup	53
Turning the Projector Off	40	• Adjusting the Tracking	54
Adjusting the Screen Image	42	• Adjusting the Sync.....	55
• Adjusting the Image Size (Zoom Function).....	42	• Selecting the Projection Quality (Colour Mode Selection)	56
• Focusing the Screen Images (Focus Adjustment).....	42	Adjusting the Volume.....	57
• Adjusting the Image Angle.....	43	Preventing theft (Password Protect)	58
• Tilting the projector vertically with respect to the screen	43	• When Password Protect is enabled	58
• When projecting from the side of the screen	43	• Entering a password with the remote control.....	59
• Adjusting the Feet	44	• Changing the Password Protect settings	59
• Manually Correcting Keystone Distortion.....	45		
• Automatic keystone correction.....	46		
• Vertical correction and horizontal correction	47		
• Height Correction.....	48		
• Correcting Keystone Distortion so that the Projection Area Fits the Screen Exactly (Quick Corner)	49		

Turning the Projector On



Turn the power on to start projecting images.

CAUTION

Be sure to read the Safety Instructions/World-Wide Warranty Terms before projecting images.

Connecting the Power Cable

PROCEDURE

- 1 Check that the power is turned off for the projector and, if necessary, that all components are connected to the projector.

- 2 **Connect the computer or other video source to the projector.** [p.18](#), [p.27](#)
When making a wireless LAN connection, set the included wireless LAN card into the card slot of the projector. [p.16](#)

- 3 Remove the lens cover.

- 4 **Connect the accessory power cable to the projector.**

Check that the power connector is facing the same way as the power inlet on the projector, and then insert the power cable connector securely into the projector.

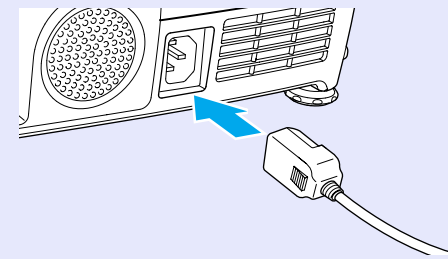

- 5 **Connect the other end of the power cable to an earthed electrical outlet.**

Wait until the  indicator lights orange.

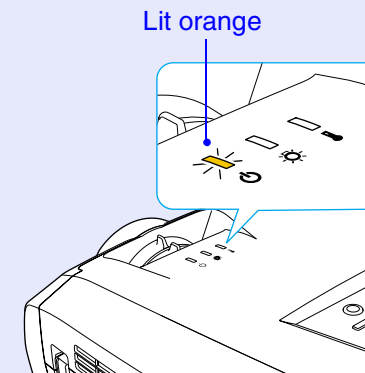

TIP

The remote control and the projector's control panel buttons will not function while the  indicator is flashing orange.



Turning the Projector On

Turning the Power On and Projecting Images



TIP

If Password Protect has been enabled, the Password Protect Release screen will be displayed when the power is turned on. Type in the password. [p.58](#)

PROCEDURE

- 1 Check that the  indicator has stopped flashing and is lit orange.
- 2 If using the remote control, set the [R/C] switch on the remote control to "ON".

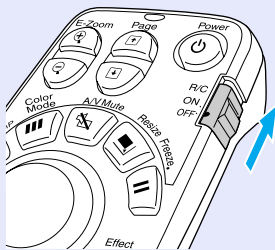

- 3 Turn the power on for all equipment connected to the projector.
For a video source, press the [Play] button at the video source to start playback if necessary.

4

Press the [Power] button on either the remote control or the projector's control panel to turn the power on for the projector.

The  indicator flashes green. After a short period it stops flashing and lights steadily, and projection starts.

Wait until the  indicator lights green (it normally takes about 40 seconds to change).

Remote control

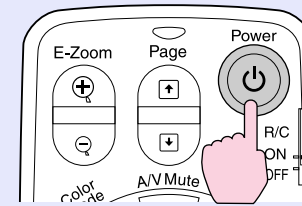

Changes from flashing to lit green

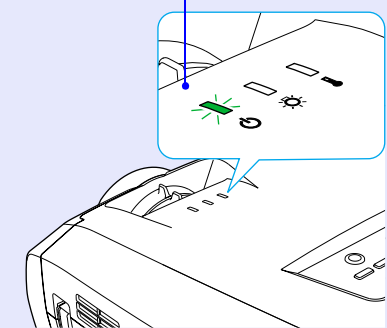

TIP

- The remote control and projector's control panel buttons will not function while the  indicator is flashing green.
- Depending on the configuration menu settings, the message "No Signal." may appear. See ["Setting" - "No-Signal Msg." p.84](#)





Turning the Projector On

- 5** If more than one external device is connected to the projector, use the remote control or projector control panel buttons to select the image source to be projected while referring to the following table.

You can also use the preview function to select the signal source. p.38

Remote control

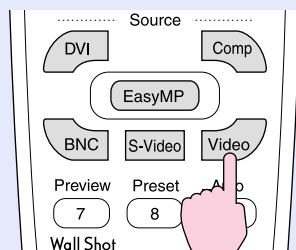

Port	Button to press		On-screen display
	Remote control	Projector	
EasyMP	[EasyMP]		EasyMP
Computer	[Comp] ^{*1}	The image source changes each time [Computer/DVI] is pressed. ^{*2}	Computer (Analog-RGB) ^{*3} Computer (RGB-Video) ^{*3}
DVI▶▶	[DVI]		DVI
BNC	[BNC] ^{*1}	The image source changes each time [Video/BNC] is pressed. ^{*4}	BNC(Analog-RGB) ^{*5} BNC(RGB-Video) ^{*5} BNC(YCbCr▶▶) ^{*5} BNC(YPbPr▶▶) ^{*5}
S-Video	[S-Video]		S-Video
Video	[Video]		Video

- ^{*1} When these buttons are pressed once, the signal name that is currently set using the configuration menus appears on the screen. You can change the signal setting by repeatedly pressing the button while the signal name is displayed. The result of this switching will also be applied to the "Computer Input" or "BNC Input" setting in the "Setting" menu.
- ^{*2} The input signal will not change to the next signal source unless the [Computer/DVI] button is pressed while the current signal name is still being displayed on the screen.
If an input signal from either the [DVI] or [Computer] port is currently being projected, the name of this current input signal will be displayed on the screen when the [Computer/DVI] button is pressed once.
- ^{*3} The item selected using the "Computer Input" command in the "Setting" menu will appear. You can change the setting by pressing the [Comp] button on the remote control.
- ^{*4} The input signal will not change to the next signal unless the [Video/BNC] button is pressed while the current signal name is still being displayed on the screen.
If an input signal from either of the [BNC], [S-Video] or [Video] ports is currently being displayed, the name of this current input signal will be displayed on the screen when the [Video/BNC] button is pressed once.
- ^{*5} The item selected using the "BNC Input" command in the "Setting" menu will appear. You can change the source to the next source in order by pressing the [BNC] button on the remote control.

- 6** When using EasyMP, change the image source to EasyMP. Refer to the *EasyMP Setup Guide* after changing.





Turning the Projector On



TIP

- If only one signal source has been connected, the signals from that source will be projected without needing to press one of the [Source] buttons.
- If the "No Signal." message does not disappear, check the connections again.
- If a laptop computer or a computer with an LCD screen has been connected to the projector by a computer cable and the images are not be projected straight away, after starting projection, check that the computer has been set up to output signals externally. The following table shows examples of how to toggle output settings. For details, refer to the section of the documentation provided with your computer under a heading such as "External output", "Connecting an external monitor" or similar.

NEC	Panasonic	Toshiba	IBM	Sony	Fujitsu	Macintosh
[Fn]+[F3]	[Fn]+[F3]	[Fn]+[F5]	[Fn]+[F7]	[Fn]+[F7]	[Fn]+[F10]	After startup, change the Control Panel adjustment so that mirroring is active.

- If the same still picture is projected for a long period of time, the projected image may become burned in on the computer screen. You should avoid leaving the same image displayed for long periods.
- Refer to the EasyMP Setup Guide for information on the functions of EasyMP.

Selecting an Image Source While Viewing Projected Images (Preview Function)

The preview function lets you project the images from the currently-selected image source and view them in a preview screen while selecting the signal source.

Use the remote control to carry out all preview function operations.

PROCEDURE

1 Press the [Preview] button on the remote control.

After a short while, a preview screen such as the one shown in the illustration below will appear on the screen.

When the preview screen is being displayed, the frames for ports that have no image signal being input or which have a signal being input that is not supported will be solid blue.

Press the [Source] buttons on the remote control to select the image source to be projected in order to change the image.

Active window

Shows the images that are currently being projected.

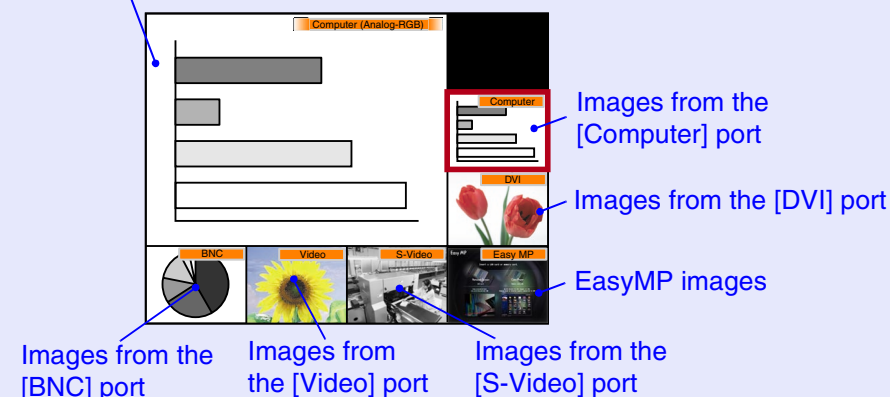



Turning the Projector On

2 Tilt the [○] button to select the images to be projected.

Move the red box until the desired image is selected.

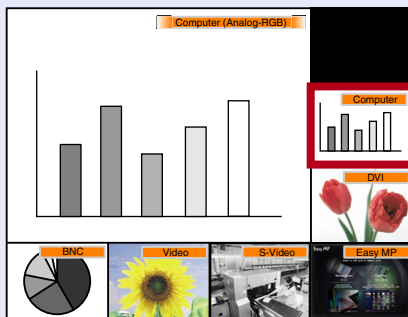

3 Press the [Enter] button.

The selected images are then projected in the active window. If you press the [Enter] button once more, the preview function is cancelled and the images in the active window are projected.

To return to the images that were being projected before the preview function was activated, press the [ESC] or [Preview] button.

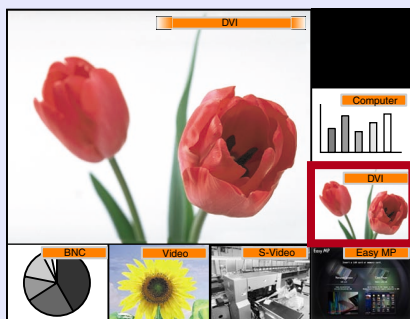

TIP

- You can hear the sound for the images in the active window while the preview window is being displayed. However, if images from a source that is connected to the [Computer] port or [DVI] port are being projected in the active window, the audio signals will be output according to the "Computer/DVI Audio Input" setting in the "Audio" menu.
- Images other than the image in the active window will be projected as still images.
- If you press the [Preview] button while E-Zoom function is active or real display is being used, these functions will be cancelled and the preview screen will be displayed. If you cancel the preview function without changing the input source, the projected images will return to the state they were at before the preview function was activated.





Turning the Projector Off

Follow the procedure below to turn the projector off.

PROCEDURE

- 1 Turn the power off for the signal sources that are connected to the projector.

Check that the power for all connected components has been turned off.

- 2 Press the [Power] button on either the remote control or the projector's control panel.

The following confirmation message will appear.

Remote control

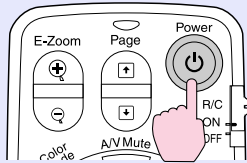

Power OFF?

Yes : Press  button
No : Press any other button

If you do not want to turn the power off, press a button other than any of the following:

- At the remote control: [Power], [↕], [↗], [⊗], [Num], [ID]
- At the control panel : [Power]

If you do not press any button, the message will disappear automatically after seven seconds. (The power will not turn off at this time.)

CAUTION

If the message "The projector is overheated. Clean or replace the air filter and lower the room temperature." appears on the screen, press the [Enter] button on the remote control or the [Auto/Enter] button on the projector's control panel to turn the power off and then clean the air filters. [p.119](#)

- 3 Press the [Power] button on either the remote control or the projector's control panel once more.

The lamp will switch off. The  indicator will flash orange and [cool-down](#) will start.

The cool-down period lasts for about 30 seconds.

When cool-down is complete, the  indicator lights orange.

Stops flashing and lights orange

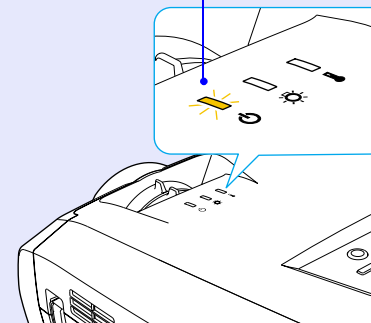

TIP

The remote control and projector's control panel buttons cannot be operated while the  indicator is flashing orange. Wait until it lights constantly.



Turning the Projector Off

- 4** If not using the projector for a long period, unplug the power cable from the electrical outlet.

CAUTION

Do not disconnect the power cable from the electrical outlet while the  indicator is flashing orange, otherwise operating problems may result.

- 5** Set the [R/C] switch to "OFF".

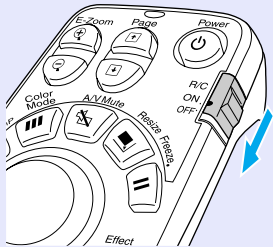

TIP

If you leave the [R/C] switch on the remote control at "ON", it will consume battery power. When not using the remote control, set the [R/C] switch to "OFF".

- 6** Attach the lens cover.

Attach the lens cover to the lens when not using the projector, in order to stop the lens from getting dusty or dirty.

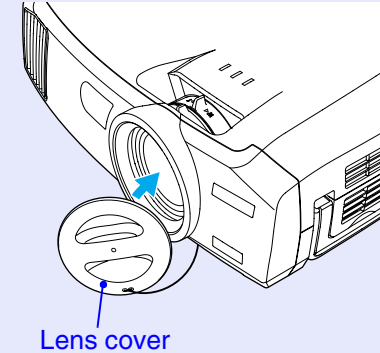



Adjusting the Screen Image

You can correct and adjust the screen images in order to obtain the best possible pictures.

Adjusting the Image Size (Zoom Function)

The size of the projected images is basically determined by the distance from the projector to the screen. p.15

The following procedures explain how to adjust the screen images once the projector itself has been set up.



TIP

The E-Zoom function can also be used to enlarge parts of the images.

p.63

PROCEDURE

Turn the zoom ring on the projector to adjust the image.

If a standard lens is fitted, the images can be enlarged in this way to 1.35 times the normal size.

If you would like to enlarge the images further, move the projector further away from the screen. p.15

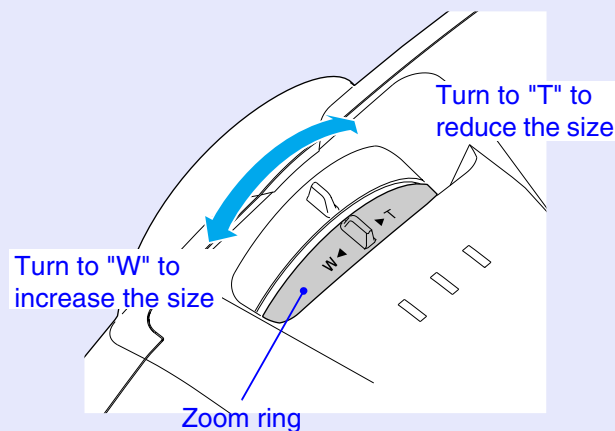

Focusing the Screen Images (Focus Adjustment)

PROCEDURE

Turn the focus ring to adjust the image focus.

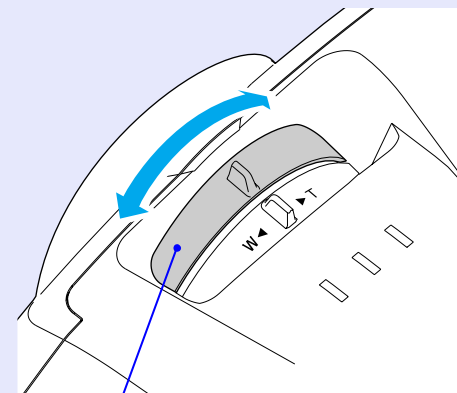

Focus ring



TIP

- *If the surface of the lens is dirty or misted over as a result of condensation, it may not be possible to adjust the focus correctly. If this happens, clean or de-mist the lens. p.103, p.119*
- *If using the standard lens and the projector is positioned outside the normal projecting range of 77–1113 cm (2.5–36.5 ft.), it may not be possible to obtain the correct focus. If you have trouble obtaining the correct focus, check the projection distance. If an optional lens is fitted, refer to the documentation for the optional lens for further details.*



Adjusting the Screen Image

Adjusting the Image Angle

If the projector is set up so that it is at a horizontal or vertical angle to the screen, adjust as follows.

■ Tilting the projector vertically with respect to the screen

If the images are being projected onto a screen that is higher than the position of the projector, extend the front adjustable foot to tilt the projector. [p.44](#)

If the images are being projected onto a screen that is lower than the position of the projector, lift up the back of the projector to tilt it.

When the projector is tilted in this way, it may cause keystone distortion to appear in the images. If this happens, you can use the keystone correction function to correct this distortion. [p.46](#)

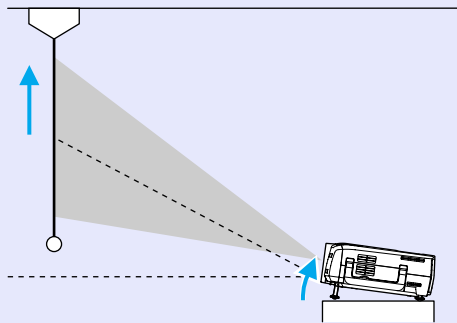

■ When projecting from the side of the screen

If the projector cannot be set up directly in front of the screen, you can project images at a horizontal angle to the screen. If keystone distortion appears in the images, you can use the projector's "H-Keystone" and "Quick Corner" functions to correct this keystone distortion. [p.47](#), [p.49](#)

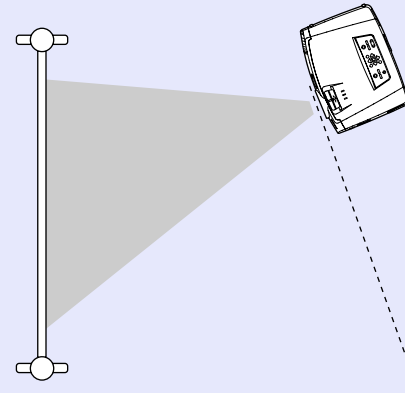



Adjusting the Screen Image

Adjusting the Feet

The front adjustable foot and the rear adjustable feet can be extended and retracted to adjust the tilt of the projector to a maximum of 12° upwards and 4° downwards.



TIP

If you use the front adjustable foot and the rear adjustable feet to adjust the tilt of the projector, it may cause keystone distortion to appear in the projected images. If this happens, the Auto Keystone function will operate to automatically project images without keystone distortion. [p.45](#)

PROCEDURE

While pulling the foot adjust lever at the front of the projector, lift up the front of the projector to extend the front adjustable foot.

Extend the front adjustable foot until the desired angle is obtained, and then release the foot adjust lever.

To retract the front adjustable foot, gently push down on the projector while pulling the foot adjust lever.

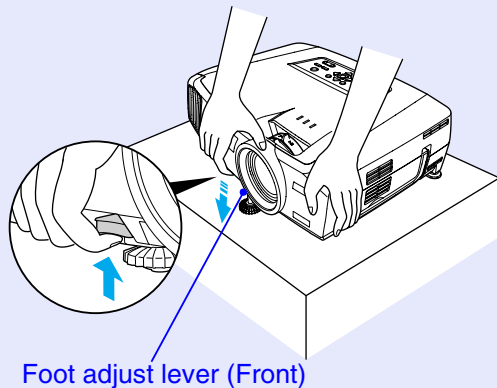

TIP

If the projector is tilted vertically or horizontally, turn the bases of the rear adjustable feet to make fine adjustments to the height of the projector. When the projector is tilted horizontally, the automatic keystone correction may not be carried out correctly.

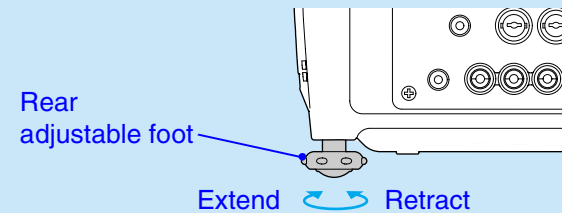



Manually Correcting Keystone Distortion

This projector is equipped with an automatic keystone correction function that detects the vertical angle of the projector during projection and automatically corrects vertical keystone distortion. If you would like to make further fine adjustments after automatic keystone correction has been carried out, or when the projector is tilted horizontally, you can carry out keystone correction manually.

TIP

If the projector is tilted within a range of approximately 30° up or down, keystone correction is carried out automatically. If the projector is tilted within a range of approximately 40° up or down or 20° to the left or right, manual keystone correction can be carried out.

However, the applicable angles will change under the following conditions.

- *If the projector has been tilted both horizontally and vertically*
- *If an optional projection lens has been fitted*
- *When the zoom is set to "W"*

This projector is equipped with the following two keystone correction functions. Use whichever function is appropriate for the keystone distortion that appears.

- **Auto Keystone/H/V-Keystone**

Automatic keystone automatically corrects keystone distortion when the projected images are vertically distorted.

H/V-Keystone can be used to make fine adjustments to the results of automatic keystone correction and to correct horizontal keystone distortion.

The keystone correction function lets you easily correct keystone distortion that has occurred after moving the projector, simply by using buttons on the projector's control panel.

See  "Automatic keystone correction" [p.46](#), "Vertical correction and horizontal correction" [p.47](#), "Height Correction" [p.48](#)

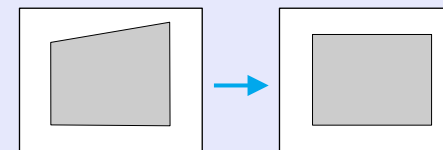
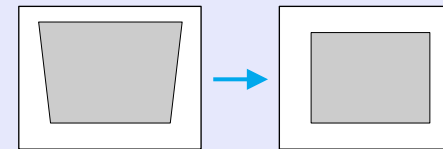

- **Quick Corner:**

This correction function is used when both horizontal and vertical keystone distortion occurs in the projection area to adjust the projection area so that it fits the screen exactly.  [p.49](#)

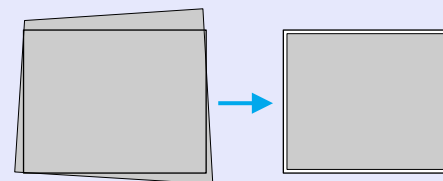

**TIP**

- The "Auto Keystone", "H/V-Keystone" and "Quick Corner" functions cannot both be used together to correct keystone distortion. If you use one function to correct keystone distortion, any correction that has been applied using the other function will be cancelled.
- The larger the angle of tilt, the poorer the focus of the contours in the projected images will become.
- If a large amount of keystone correction is applied, fine details such as text characters and lines may go out of focus.
- Keystone corrections that have been applied using the keystone correction functions are memorised even when the projector's power is turned off. If you have changed the projection position or angle, you will need to repeat the correction procedure.
- "H-Keystone" and "Height" cannot be used at the same time.
- When keystone correction is carried out, the projected images will become smaller. Use the zoom function to adjust the size of the images if necessary. [☛ p.42](#)
- If the images become uneven in appearance after keystone correction is carried out, decrease the sharpness. [☛ p.76, p.79](#)

Automatic keystone correction

When the projector has been tilted vertically, automatic keystone correction is carried out so that images with no distortion are projected.

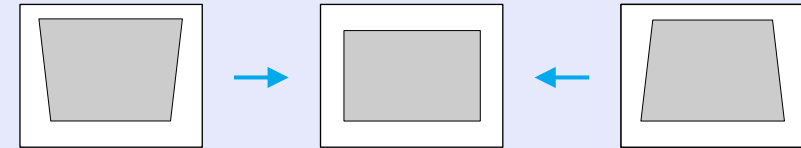

Automatic keystone correction is carried out approximately one second after the projector is set up and projection starts. A vertical keystone correction gauge appears on the screen while automatic adjustment is in progress.

**TIP**

- Automatic keystone correction is not carried out if "Rear Proj." or "Ceiling" in the "Advanced1" menu is set to "ON", or if the projection area has been corrected manually using the "Quick Corner" function.
- If you would like to make further fine adjustments after automatic keystone correction has been carried out, or if the projector is tilted horizontally, you can carry out keystone correction manually. [☛ p.47](#)
- If you do not want automatic keystone correction to be carried out, change the "Auto Keystone" setting in the "H/V-Keystone" sub-menu of the "Keystone" command in the "Setting" menu to "OFF". [☛ p.83](#)





Adjusting the Screen Image

Vertical correction and horizontal correction

Vertical correction and horizontal correction can be carried out using either the projector's control panel or the configuration menus. This procedure explains how to use the projector's control panel to correct keystone distortion.

For adjustment using the configuration menus: [p.83](#) "Setting" - "Keystone" - "H/V-Keystone"

If you use the horizontal correction function when height correction adjustment has already been carried out, the height correction adjustment will be cancelled.



TIP

If "Quick Corner" is selected in the "Keystone" sub-menu of the "Setting" menu, the "Quick Corner" correction screen will be displayed if you press the [▲], [▼], [◀] or [▶] buttons. [p.49](#)
When carrying out vertical correction and horizontal correction, select "H/V-Keystone" and then make the correction. [p.83](#)

PROCEDURE

If the top of the image is elongated

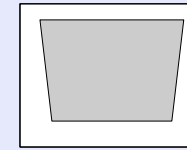

Projector

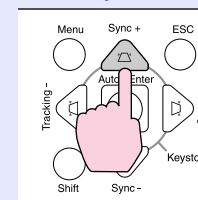

If the bottom of the image is elongated

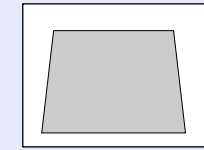

Projector

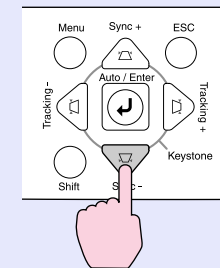

If the left edge of the image is elongated

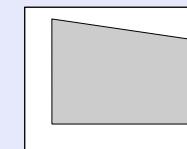

Projector

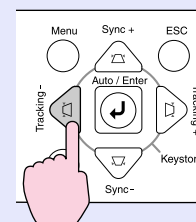

If the right edge of the image is elongated

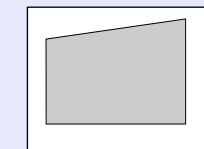

Projector

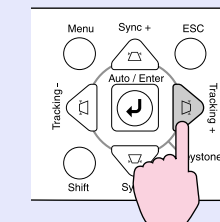

**TIP**

If the value displayed in the gauge on the screen stops changing when vertical correction and horizontal correction is being carried out, it indicates that the limit for vertical correction and horizontal correction has been exceeded. Check that the projector has not been set up at an angle which exceeds the proper limit.

Height Correction

When Automatic keystone correction or horizontal correction is carried out, the height of the projected images will become shorter. Use the height correction function to adjust the height of the projection area. The height correction function is accessible from the configuration menu. This cannot be set when vertical correction is carried out.

PROCEDURE

- 1 Press the [Menu] button on either the remote control or the projector's control panel. Then select "Height" from the "H/V-Keystone" sub-item of the "Keystone" command in the "Setting" menu.

For details, refer to "Using the Configuration Menus" p.92

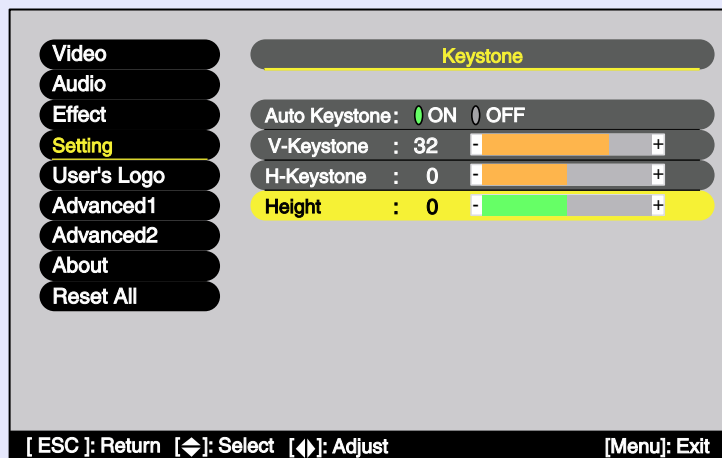

2

Tilt the [⊙] button on the remote control to the left or right, or press the [◀] or [▶] buttons on the projector's control panel to correct the height while viewing the projected images.

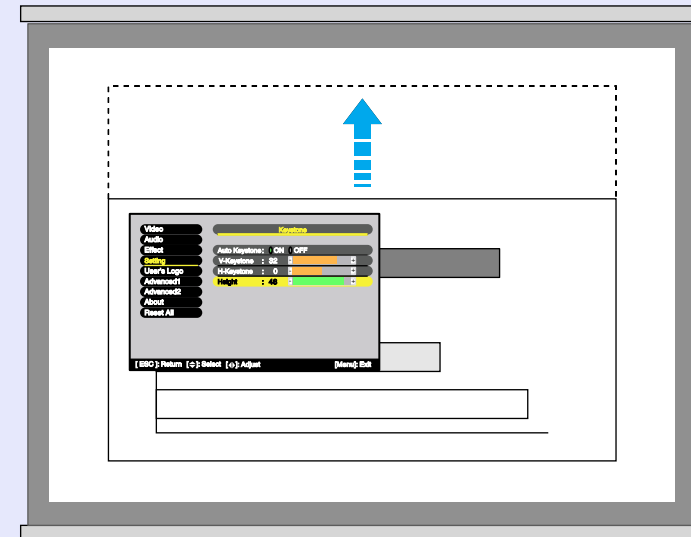

3

When the adjustment is complete, press the [Menu] button on the remote control or the projector's control panel to close the configuration menu.





Correcting Keystone Distortion so that the Projection Area Fits the Screen Exactly (Quick Corner)

Quick Corner correction can be carried out using either the projector's control panel or the configuration menus. This procedure explains how to use the projector's control panel to correct keystone distortion.

If using the configuration menu: "Setting" - "Keystone" - "Quick Corner"

☞ p.83



TIP

If "H/V-Keystone" is selected in the "Keystone" sub-menu of the "Setting" menu, the "V-Keystone" or "H-Keystone" adjustment gauge will be displayed if you press the [△], [▽], [◀] or [▶] buttons.

☞ p.47

When carrying out "Quick Corner" correction, select "Quick Corner" and then make the correction. ☞ p.83

PROCEDURE

- 1 Press the [△], [▽], [◀] or [▶] button on the projector's control panel.

The Quick Corner correction screen will be displayed.

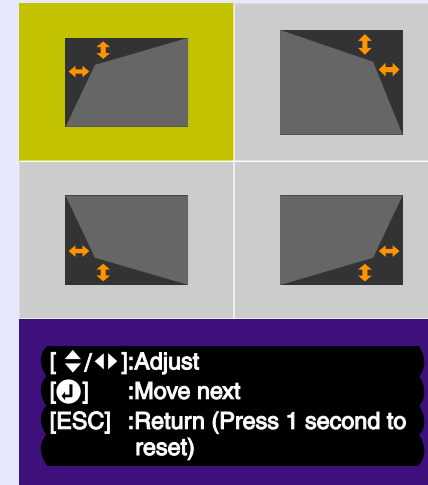



Adjusting the Screen Image

- 2** Press the [Auto/Enter] button on the projector's control panel and then select the corner to be corrected on the screen.

You can also press the [Enter] button on the remote control to select the corner.

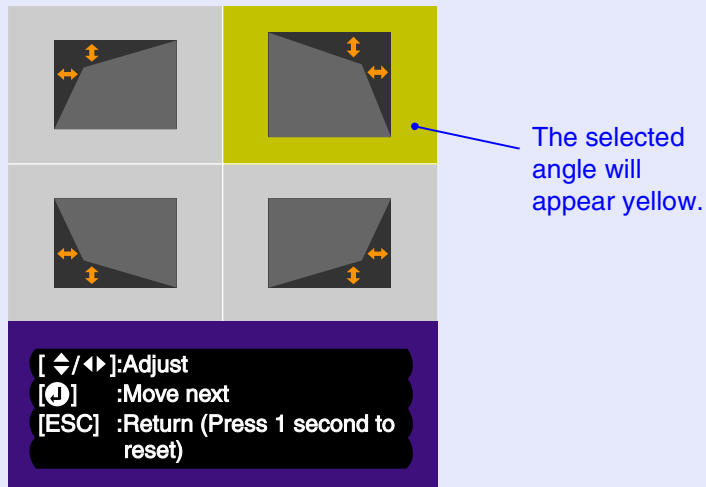

- 3** Press the [△], [▽], [◀] and [▶] buttons on the remote control to correct the angle position.

You can also tilt the [○] button on the remote control to correct the angle position.

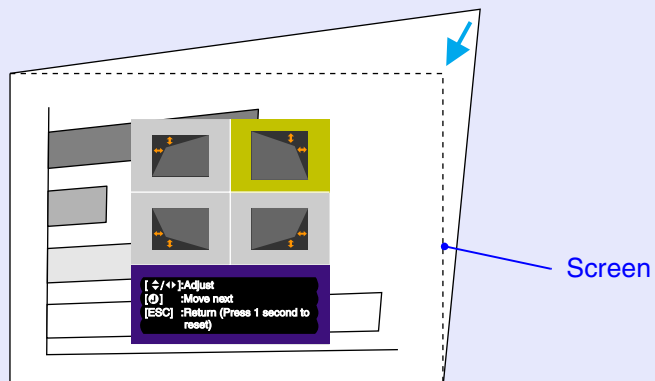

TIP

- If you press down the [ESC] button on the remote control or the projector's control panel for one second while the Quick Corner correction screen is displayed, the correction results will be restored to their default values.
- If the message "Cannot move anymore." appears on the screen while using the Quick Corner function, it means that the limit for correction has been reached. Check the following two points.
 - Is the projection distance appropriate for the size of the projection screen? [p.15](#)
 - Is the projector tilted too much? [p.45](#)
- If the input signal is interrupted or an image signal that is not supported is input while using the Quick Corner function, the correction value at that point will be recorded and the Quick Corner function will be cancelled.
- When the Quick Corner correction screen is displayed, the following functions will be cancelled.
 - E-Zoom function
 - Real display
 - Freeze

- 4** When the adjustment is complete, press the [Menu] button on either the remote control or the projector's control panel to close the configuration menu.





Adjusting the Image Quality

The quality of the projected images can be adjusted as follows.

Projecting Easy-to-see Images Without a Screen (Wall Shot)

When the Wall Shot function is used, images can be projected without loss of original colour even onto surfaces such as blackboards and coloured wall surfaces which are being used instead of a screen. For example, if projecting onto a green blackboard, the projected images would normally appear greenish and be very difficult to see. The Wall Shot function uses a sensor to measure the condition of the projection surface and automatically adjusts the colour of the projected images based on these measurements. The Wall Shot function also allows shading to be adjusted. If projecting onto a screen that is located near a window, the Wall Shot function can be used to obtain clear images when they might otherwise appear faded.



TIP

- *Wall Shot can be used for adjustment if the projection distance is within approximately 80–1000 cm (2.6–32.8 ft.). However, this distance will vary depending on the condition of the projected surface, for instance if the projection surface is an extremely reflective surface such as a whiteboard, or if it is a highly non-reflective surface such as a dark wall.*
- *The sensor may not be able to correctly measure the condition of the projection surface if you are projecting on a striped or patterned wall. In this event, Wall Shot may not be able to correctly adjust the color of the projected images.*

PROCEDURE

The Wall Shot function can be operated using either the remote control or the projector's control panel.

1

Press the [Wall Shot] button on either the remote control or the projector's control panel while the images are being projected.

When the button is pressed, the current status is displayed on the screen.

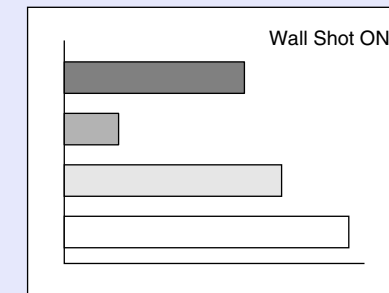
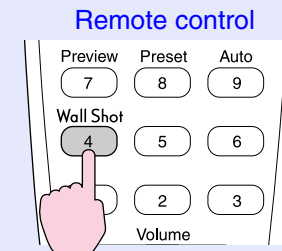



2 To change the status, press the [Wall Shot] button while the status is being displayed on the screen.

For example, if you press the [Wall Shot] button while "Wall Shot OFF" is displayed, the status will change to "Wall Shot ON" and measurement of the projection surface will start. Colours in the order red → green → blue → black will be projected for approximately five seconds while measurement is in progress.

3 Once the measurement is finished and colour correction is complete, the images will be projected in the corrected condition.

To cancel the correction, press the [Wall Shot] button while "Wall Shot ON" is being displayed on the screen so that "Wall Shot OFF" is selected.



TIP

- *When the projector's power is turned off, images will be projected next time with the status set to "Wall Shot OFF". However, the correction values that were obtained by the previous measurement operation will be stored even when the power is turned off. If projecting in the same location as before, you can retrieve the colour correction values that were used previously (the five seconds required for readjustment will not be necessary). The status will change as follows each time the [Wall Shot] button is pressed.*

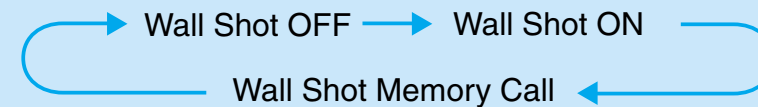

When "Wall Shot retrieval" is selected, the previous adjustment values are retrieved.

- *If you change the projection location or change the condition of the projection surface, you should repeat the Wall Shot measurements. If you press the [Wall Shot] button twice while "Wall Shot ON" is being displayed, "Wall Shot Readjustment" will be displayed and adjustment will then start.*

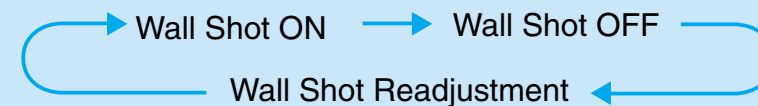



Adjusting Computer Images

Automatic Setup

Automatic setup detects analogue RGB signals coming from a connected computer connected by a computer cable, and automatically adjusts these signals so that the optimum images can be obtained.

Automatic setup involves adjustment of the following three items:

[Tracking](#), Position and [Sync](#).



TIP

- If "Auto Setup" in the "Advanced2" menu is set to "OFF" (the default setting for this command is "ON"), automatic setup is not carried out. If you press the [Auto] button on the remote control or the [Auto/Enter] button on the projector's control panel while computer images (analogue RGB signals) are being projected, adjustment will then be carried out.

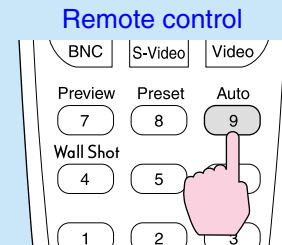

- If you press the [Auto] button on the remote control or the [Auto/Enter] button on the projector's control panel while the E-Zoom function or Freeze function is active, the active function will be cancelled and then the adjustment will be carried out.
- Sometimes the signals may not be adjusted correctly depending on the type of signals being output by the computer. In such cases, use the "Tracking", "Position" and "Sync." menu commands to make the adjustments manually. [p.54](#), [p.55](#), [p.76](#)
- Automatic setup is not carried out while the preview function is being used.



Adjusting the Image Quality

Adjusting the Tracking

If vertical stripes appear in the projected images, and this cannot be fixed using automatic setup, you will need to adjust the [tracking](#) manually using the following procedure.

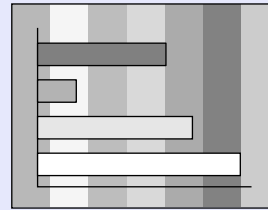

PROCEDURE

Tracking adjustment can be carried out using either the projector's control panel or the configuration menus. This procedure explains how to use the projector's control panel to adjust the tracking.

For adjustment using the configuration menus:
See "Video" - "Tracking" p.76

Press the following buttons to adjust the tracking value until the vertical stripes disappear from the projected images.

While holding down the [Shift] button on the projector's control panel, press the [D] button.

The tracking value increases each time the button is pressed.

Projector

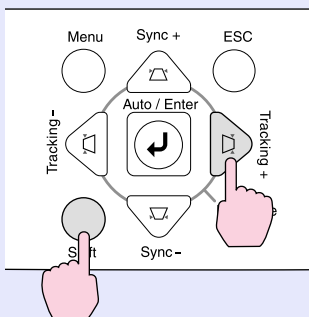

While holding down the [Shift] button on the projector's control panel, press the [D] button.

The tracking value decreases each time the button is pressed.

Projector

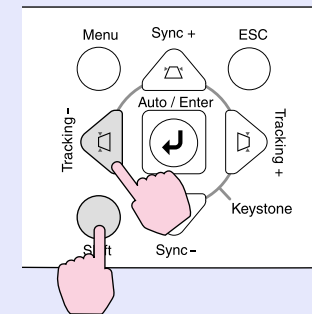

TIP

The images will flash when continuous tracking adjustment is carried out, but this is normal.



Adjusting the Image Quality

Adjusting the Sync

If flickering, fuzziness or interference appear in images that are input from the computer, and this cannot be fixed using automatic setup, you will need to adjust the [sync](#) manually using the following procedure.

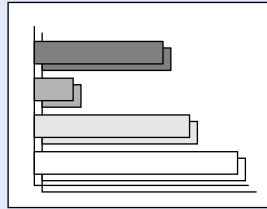

PROCEDURE

Sync adjustment can be carried out using either the projector's control panel or the configuration menus. This procedure explains how to use the projector's control panel to adjust the sync.

For adjustment using the configuration menus:

See ["Video" - "Sync." p.76](#)

Press the following buttons to adjust the sync value until the flickering, fuzziness or interference disappears from the projected images.

While holding down the [Shift] button on the projector's control panel, press the [] button.

The sync value increases each time the button is pressed.

Projector

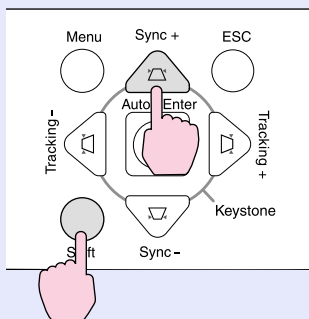

While holding down the [Shift] button on the projector's control panel, press the [] button.

The sync value decreases each time the button is pressed.

Projector

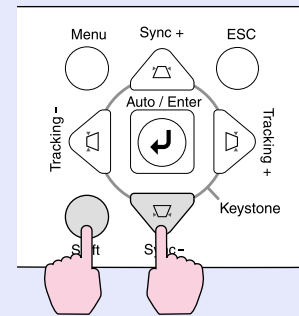

TIP

- *If you adjust the sync without adjusting the tracking first, it will not be possible to get the best adjustment results. Incorrect tracking adjustment may not be noticeable with some types of image. However, images with lots of lines and shading will tend to show incorrect tracking adjustments more clearly, so be sure to check the tracking adjustment first.*
- *It may also be possible to fix flickering and fuzziness by adjusting the brightness, [contrast](#), sharpness and keystone correction settings.*



Selecting the Projection Quality (Colour Mode Selection)

The following five preset colour modes are available for use depending on the characteristics of the images that are being projected. You can easily obtain the optimum image quality simply by selecting the colour mode that corresponds to the projected images. The brightness of the images will vary depending on which colour mode is selected.

Mode	Application
Dynamic	Images are modulated and made fresher to emphasise brightness.
Presentation	Brightness is emphasised. For presentations in bright rooms.
Theatre	Movie images are optimised using natural tints.
Living Room	Brightness is emphasised. Ideal for playing video games in bright rooms.
sRGB ▶▶	Images conform to the sRGB colour standard. If the connected source has a sRGB mode, set both the projector and the connected signal source to sRGB.

PROCEDURE

Selecting the colour mode can be carried out using either the remote control or the configuration menus. This procedure explains how to use the remote control to select the colour mode.

For selecting using the configuration menus
See 🖱️ "Video" - "Color Mode" p.77, p.80

The colour mode changes as follows each time the [Color Mode] button on the remote control is pressed.

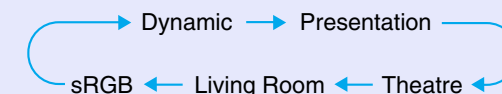
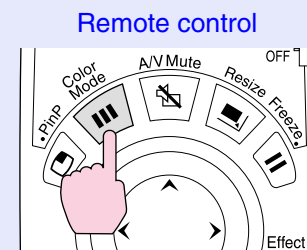

The current setting is displayed on the screen each time the mode is changed.

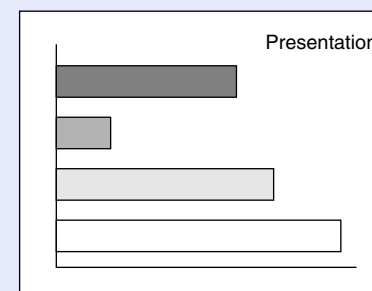

The default setting for the colour mode is as follows:

When computer images are being input: "Presentation"

When other types of images are being projected: "Dynamic"



Adjusting the Volume

You can adjust the volume for the sound from the projector's built-in speaker or from the external speakers that are connected to the projector.



PROCEDURE

The volume can be adjusted using either the remote control, the projector's control panel or the configuration menus. This procedure explains how to use the remote control and the projector's control panel to adjust the volume.

For adjustment using the configuration menus:

See  "Audio" - "Volume" [p.81](#)

Press the [Volume] button on either the remote control or the projector's control panel.

When the button is pressed to the [] side, the volume increases, and when it is pressed to the [] side, the volume decreases.

The volume gauge appears on the screen when the volume is being adjusted.

Remote control

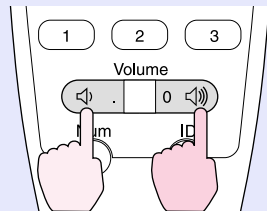

TIP

- *If the value displayed in the gauge on the screen stops changing when the volume is being adjusted, it indicates that the limit for volume adjustment has been reached.*
- *The volume adjustments are stored individually for each image source.*



Preventing theft (Password Protect)

The projector is provided with a Password Protect function. When Password Protect is set to "ON", a password entry screen is displayed when the power is next turned on after the power plug has been disconnected from the electrical outlet, and you must enter a password before projection can start. This means that the projector cannot be taken away and used by someone else, thereby providing a defence against theft.

The default setting is for Password Protect to be "OFF". You should change the Password Protect setting to "ON" and set a password as soon as possible after starting to use the projector.

When Password Protect is enabled

When Password Protect is enabled (ON), a Password Protect Release screen requesting you to enter a password will be displayed when the power plug is inserted into the electrical outlet and the power for the projector is first turned on.

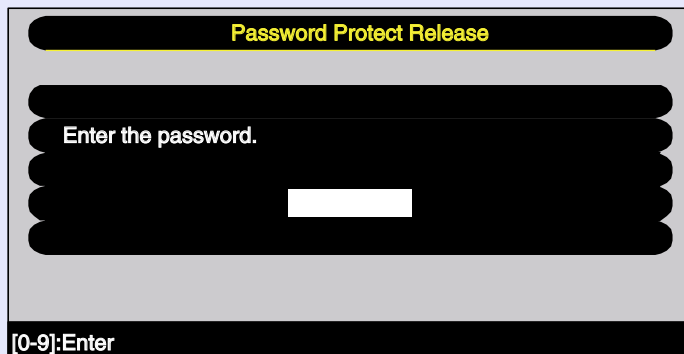

Use the numeric buttons on the remote control to set the password.  p.59
If the correct password is entered, projection will then start.

If you leave the power plug connected to the electrical outlet, the Password Protect Release screen will not be displayed the next time the projector's power is turned on and projection can be started straight away. The Password Protect Release screen will only be displayed the first time the projector's power is turned on after the power cord has been inserted into an electrical outlet.



TIP

- ***If an incorrect password is entered three times in succession, the message "The projector's operation will be locked." will be displayed for approximately five minutes, and then the projector will switch to standby mode. If this happens, disconnect the power plug from the electrical outlet and then reinsert it and turn the projector's power back on. The screen requesting you to enter the password will be displayed, so enter the password correctly.***
If you happen to forget the password, make a note of the request code: xxxx number that appears in the Password Protect Release screen and contact the nearest address provided in the "International Warranty Conditions" section of the Safety Instructions/World-Wide Warranty Terms booklet.
- ***If the above operation should happen to be repeated nine times without a correct password being entered, the following message will be displayed and the projector's power will not be able to be turned on.***
"The projector's operation will be locked. Contact the nearest address provided in the "International Warranty Conditions" section of the Safety Instructions/World-Wide Warranty Terms booklet.



Preventing theft (Password Protect)

Entering a password with the remote control

Press the [Num] button on the remote control to enter the password. If you press the [Num] button, it will light up and the remote control buttons will change to numeric keypad mode so that you can enter numbers.

If you press the [Num] button once more, it will stop lighting up and numeric keypad mode will be cancelled.

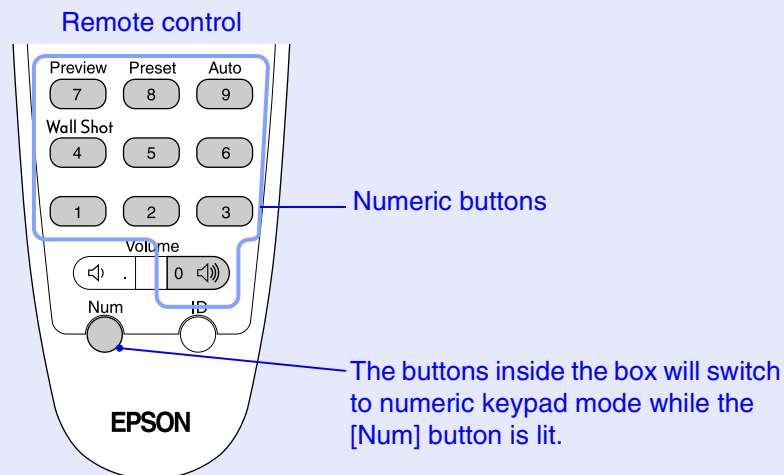

Changing the Password Protect settings

Follow the procedure given below to enable Password Protect and to set the password.

PROCEDURE

- 1 Press the [Freeze] button on the remote control for approximately five seconds. If using the projector's control panel, hold down the [D] button and press the [Menu] button for approximately five seconds.

The Password Protect menu will be displayed.

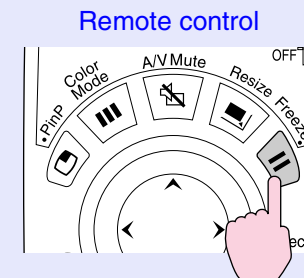

TIP

If Password Protect has already been enabled, the "Password Protect Release" screen will be displayed.

When the correct password has been entered, the "Password Protect" menu will be displayed.

See "When Password Protect is enabled" p.58





Preventing theft (Password Protect)

- 2** Set Password Protect to "ON" and then press the [Enter] button on the remote control or the [Auto/Enter] button on the projector's control panel.



- 3** To set the password, select Password and then press the [Enter] button on the remote control or the [Auto/Enter] button on the projector's control panel.

- 4** When the message Change the password? is displayed, select Yes and then press the [Enter] button on the remote control or the [Auto/Enter] button on the projector's control panel.

The default setting for the password is "0000", and you can change it to the required password.

If you select "No", the display will return to the screen in step 2.

- 5** Enter a 4-digit password.

Press the [Num] button on the remote control, and then use the numeric keypad to enter a 4-digit number.

The password entered will be displayed as "* * * *".

Once four digits have been entered, the following confirmation screen will be displayed.

- 6** Re-enter the password that you entered in step 5.

The message "The new password is stored." will be displayed. If you enter the password incorrectly, a message will be displayed prompting you to re-enter the password.

- 7** Once the setting is complete, press the [Menu] button.

Press the [Num] button on the remote control to cancel numeric keypad mode.

Check that the [Num] button indicator is turned off.

The Password Protect function will be enabled next time the power plug is inserted into an electrical outlet and the projector's power is turned on.



TIP

- When Password Protect has been set to "ON", attach the Password Protect stickers to your preferred place on the projector to increase anti-theft effectiveness.
- Make a note of the password so that you do not forget it and keep it in a safe place.
- If you lose the remote control, you will not be able to enter the password. Keep the remote control in a safe place at all times.





Advanced Operations

This chapter describes functions for enhancing the projection of images, and how to use the configuration menus.

Functions for Enhancing Projection	62
• A/V Mute Function	62
• Freeze Function	63
• E-Zoom Function	63
• P in P (Picture in Picture) Function	64
• Effect Function	66
• Using the Pointer Icon	66
• Drawing Straight and Curved Lines	67
• Preset Function	68
• Saving "Video" Menu Settings	68
• Applying Saved "Video" Menu Settings	70
• Changing the Resize/Aspect Ratio	70
• Selecting the Computer Display Method	70
• Projecting Wide-screen Images from Video Equipment	72
• Projector ID/Remote Control ID	73
• Registering an ID Number for a Projector	73
• Registering an ID Number for a Remote Control	74

Using the Configuration Menu Functions	75
• List of Functions	76
• "Video" Menu	76
• "Audio" Menu	81
• "Effect" Menu	82
• "Setting" Menu	83
• "User's Logo" Menu	85
• "Advanced1" Menu	86
• "Advanced2" Menu	89
• "About" Menu	90
• "Reset All" Menu	91
• Using the Configuration Menus	92



Functions for Enhancing Projection

This section describes the various useful functions that can be used to enhance presentations.

A/V Mute Function

This function momentarily pauses the images and sound. For example, it can be used when you do not wish to show details of operations such as selecting different files while computer images are being projected. However, if you use this function when projecting moving images, the images and sound will still continue to be played back by the source, and you cannot return to the point where the A/V Mute function was activated.

PROCEDURE

Press the [A/V Mute] button on either the remote control or the projector's control panel.

The images and sound will then be paused.

Remote control

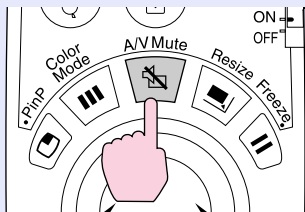

Press the [A/V Mute] button once more to continue normal projection.

You can also continue normal projection by pressing the [ESC] key on either the remote control or the projector's control panel.

You can use the "A/V Mute" command in the "Setting" menu to set the screen appearance when the images and sound have been paused to any one of the following three settings. [p.84](#)

Solid black

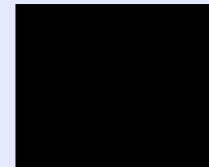

Default setting

Solid blue

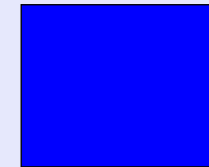

User's logo

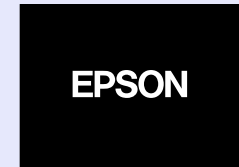

TIP

The default user's logo is the EPSON logo. You can change the user's logo by recording and setting your own logo. [p.126](#)



Functions for Enhancing Projection

Freeze Function

This function pauses only the projected images. The sound keeps playing without pausing.

The signal source will still be playing back the images even while projection is paused, and so it will not be possible to resume projection from the point where it was paused.

PROCEDURE

Press the [Freeze] button on the remote control.

The images will then be paused.

Remote control

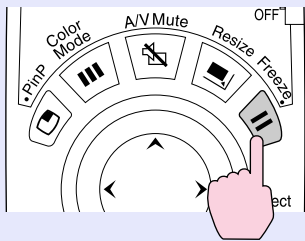

To continue projecting the images, press the [Freeze] button once more. You can also continue normal projection by pressing the [ESC] button on either the remote control or the projector's control panel.



TIP

- If you press the [Freeze] button on the remote control while a configuration menu or help menu is displayed, the configuration menu and help menu display is cancelled.
- The Freeze function also works while the E-Zoom function is being used.

E-Zoom Function

This function lets you enlarge and reduce a parts of projected images such as graphs and tables.

The E-Zoom function is controlled using the remote control.

PROCEDURE

1

Press the [E-Zoom +] button on the remote control.

A cursor (cross) indicating the centre point for the area to be enlarged will appear on the screen.

Remote control

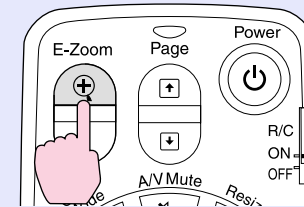

2

Move the cross to the area of the image that is to be enlarged.

Tilt the [○] button on the remote control to move the cross.

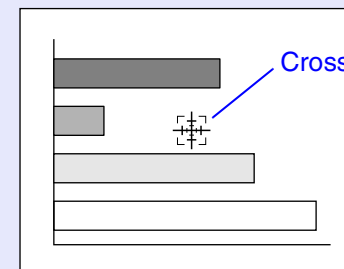



- 3** When the [⊕] button is pressed, the image is enlarged with the cross at its centre. When the [⊖] button is pressed, the enlarged image is then reduced.

The enlargement ratio will appear at the bottom-right of the screen.

You can scroll around the image by tilting the [○] button.

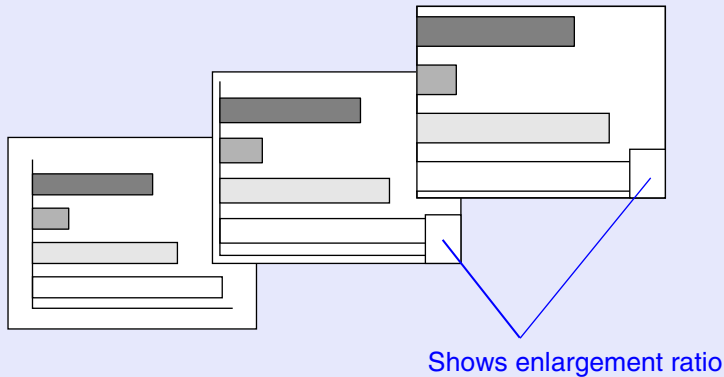

To cancel the E-Zoom function, press the [ESC] button.

**TIP**

The selected area can be enlarged to between 1–4 times, in 25 steps of $\times 0.125$.

P in P (Picture in Picture) Function

This function lets you display separate images in a smaller screen (sub-screen) over the top of the images that are currently being projected (main screen).

Computer images and EasyMP images can be displayed in the main screen, and video images ([composite video](#) or [S-Video](#)) can be displayed in the sub-screen.

The video images in the sub-screen can be selected using the "P in P" command in the "Setting" menu. [p.83](#)

The P in P function is controlled using the remote control.

**TIP**

The P in P function cannot be used for computer images that have the [refresh rate](#) set to [interlaced](#), or for RGB video images.

PROCEDURE

1

Connect the equipment to be used for projecting the main screen and sub-screen images, set the type of sub-screen using the "P in P" command in the "Setting" menu, and then press the [PinP] button on the remote control.

The sub-screen will appear at the top-left of the screen, and the operation guide will appear at the bottom-left of the screen.

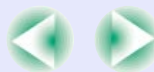
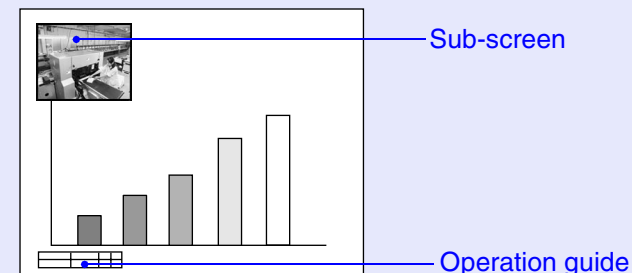



- 2** Tilt the [○] button on the remote control to change the position of the sub-screen.

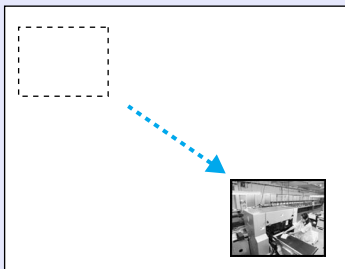

- 3** Press the [E-Zoom] button on the remote control to change the size of the sub-screen to one of five available sizes.

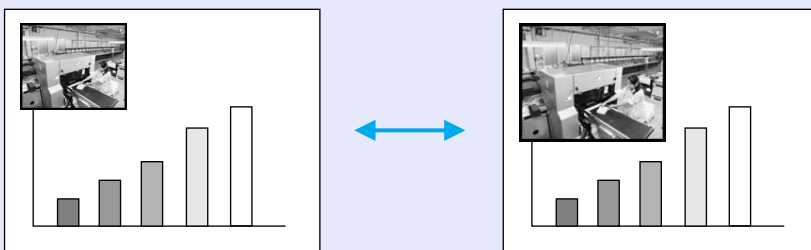

The values given below are the ratios for the sides of the sub-screen when the width and height of the main screen is 1.

Size 1	Size 2	Size 3	Size 4	Size 5
Approx.	Approx.	Approx.	Approx.	Approx.
1/3.4	1/3.2	1/3.0	1/2.8	1/2.7

Size 2 is the default size for the sub-screen when the [PinP] button is pressed.

- 4** When you press the [Enter] button, the operation guide screen will disappear and the display position and size for the sub-screen will be accepted.

To cancel the P in P function, press the [PinP] button once more.

TIP

- *The position of the sub-screen is memorised, so that the sub-screen will appear in the last position which was set next time the P in P function is used.*
- *Before setting the display position and size for the sub-screen, you can carry out the following operations to switch the sound output between the main screen and the sub-screen.*
 - *To output the sound for the main screen: Press the [Color Mode] button.*
 - *To output the sound for the sub-screen: Press the [A/V Mute] button.*





Effect Function

You can display a pointer icon on the images being projected, and then use the remote control to draw straight and curved lines.

This function can be used to emphasise parts of an image that you want to draw attention to.

The Effect function is controlled using the remote control.



TIP

You can use the "Effect" menu to change various settings for the pointer icon, such as type, size, movement speed, and the colour and thickness of the line that is drawn. The selected settings can be saved as "Pointer/Line1", "Pointer/Line2" or "Pointer/Line3" and then retrieved when required. [p.82](#)

Using the Pointer Icon

You can use the pointer icon to draw attention to parts of projected images that you would like to explain about during a presentation, for example.

PROCEDURE

1 Press the [Effect] button on the remote control.

The pointer icon will appear in the middle of the projection area. The pointer icon will change to the icon set for "Pointer/Line1", "Pointer/Line2" and "Pointer/Line3" in that order each time the [Effect] button is pressed.

Remote control

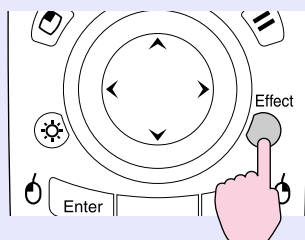

2

Tilt the [○] button to move the pointer icon.

To cancel the Effect function, press the [ESC] button. The pointer icon will then disappear from the screen.

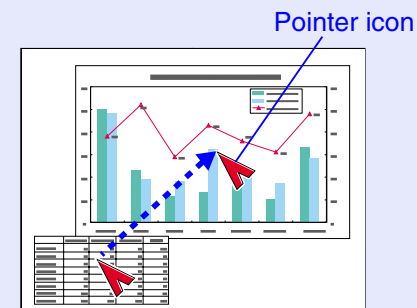

TIP

The last pointer icon type used will remain as the current pointer icon until the projector's power is turned off, so that when the Effect function is used, that pointer icon will appear. When the projector's power is turned off, the pointer icon that has been saved using the "Pointer/Line 1" command will be the first pointer icon to be displayed the next time the Effect function is used.



Drawing Straight and Curved Lines

You can draw straight lines to emphasise aspects of an image, and draw freehand lines to circle parts of the image at times such as when giving presentations.

PROCEDURE

1 Press the [Effect] button on the remote control.

The pointer icon will appear in the middle of the projection area.

The pointer icon will change to the icon set for "Pointer/Line1", "Pointer/Line2" and "Pointer/Line3" in that order each time the [Effect] button is pressed, and you can then select the type of line that has also been set for that pointer type.

Remote control

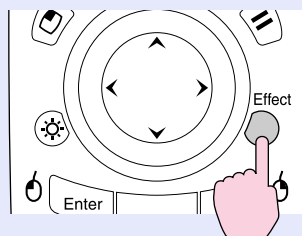

2 Set the starting point for the line.

Straight line : Move the pointer icon to the starting point for the line and press the [Enter] button.

Curved line : Move the pointer icon to the starting point for the line and hold the [Enter] button down for approximately 1.5 seconds to start drag mode. The [Enter] button will light.

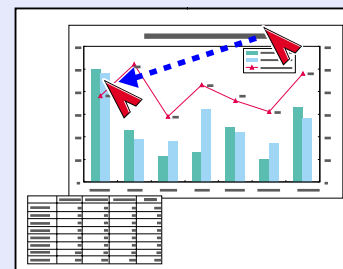

3 Set the ending point for the line.

Straight line : Move the pointer icon to the ending point for the line and press the [Enter] button.

Curved line : Move the pointer icon to the ending point for the line. The path moved by the pointer icon will appear as a line drawn on the screen. Press the [Enter] or [ESC] button. The light for the [Enter] button will turn off.

Straight line Curved line





TIP

- *The thickness and colour of the line cannot be changed by pressing the [Effect] button during the time in between when the starting point is set and the ending point is accepted.*
- *Straight lines and curved lines cannot be erased individually. All lines will disappear at the same time when the Effect function is cancelled.*

4

To draw further lines, repeat steps 2 and 3.

To cancel the Effect function, press the [ESC] button. The pointer icon and the lines that have been drawn will then disappear from the screen.

Preset Function

When projecting analogue RGB video signals being input from a computer connected by a computer cable, you can change the settings for these signals using the "Video" menu. Up to ten different sets of these settings can be saved.

When the setting values for different resolutions and frequencies that have been made using the "Video" menu have been saved in this way, you can then load these settings and apply them to analogue RGB video signals that are currently being projected just by pressing the [Preset] button on the remote control.

■ Saving "Video" Menu Settings

PROCEDURE

1

Press the [Menu] button on either the remote control or the projector's control panel, and then select the "Video" menu from the main menu. Then make the settings that you would like to be saved. p.76

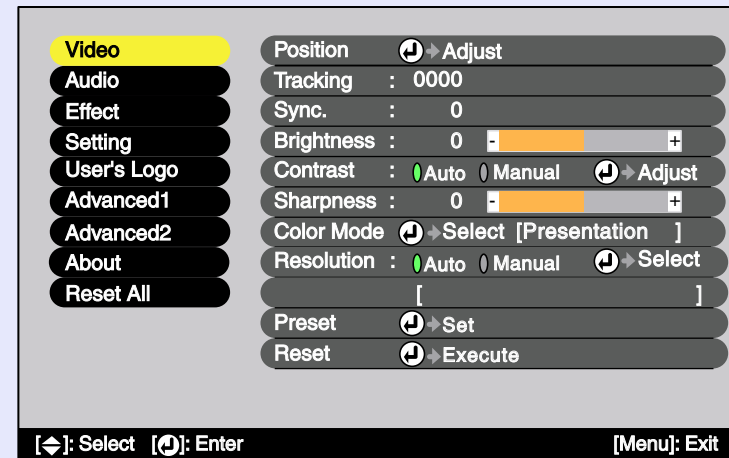



Functions for Enhancing Projection

- 2 Once the settings have been made, select "Preset" in the sub-menu and then press the [Enter] button on the remote control or the [Auto/Enter] button on the projector's control panel.

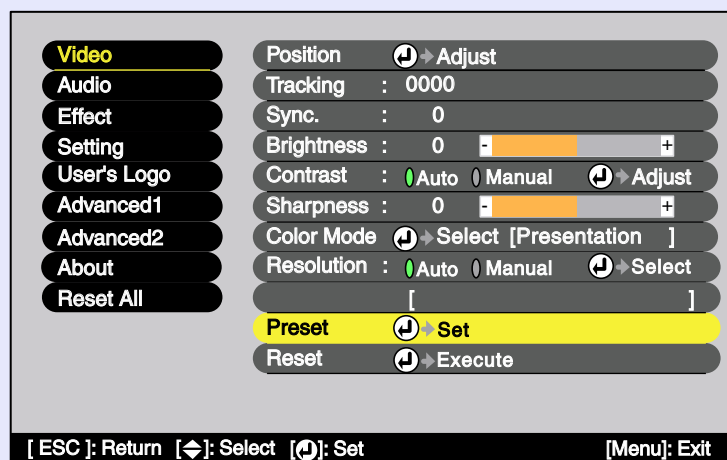

- 3 Select a number (1–10) for saving the settings.

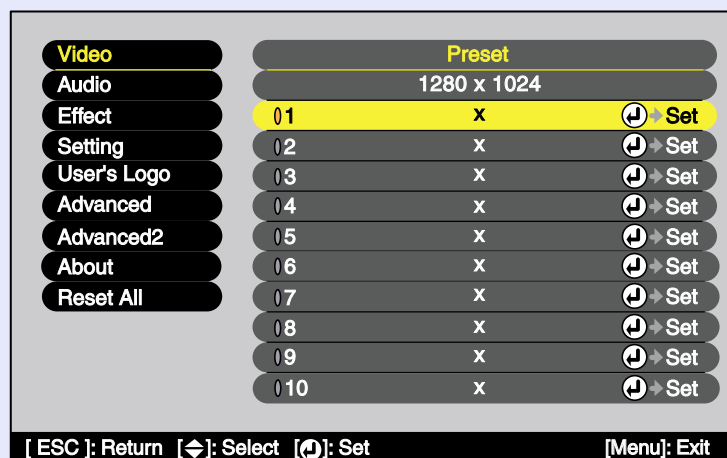

TIP

The preset numbers that have an input resolution displayed have already been set. If you select a preset number that has already been set and use it to save the current settings, the existing settings in that recording area will be overwritten.



- 4 Press the [Enter] button on the remote control or the [Auto/Enter] button on the projector's control panel to save the "Video" menu settings.

When the settings have been saved, the input resolution will appear.

Remote control

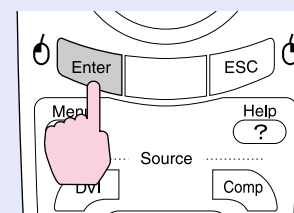

TIP

- To clear the memorised details, select "Reset" from the "Video" menu. Note that this will clear all of the preset settings.
- Preset recording is possible regardless of whether Wall Shot is on or off. However, the Wall Shot settings are not memorised.





Functions for Enhancing Projection

■ Applying Saved "Video" Menu Settings

PROCEDURE

While projecting analogue RGB images from a computer connected by a computer cable, press the [Preset] button on the remote control to apply the saved setting values for the "Video" menu to the images that are currently being projected.

The memorised preset number changes in ascending order starting from the lowest recording area number each time the button is pressed.

You must press the [Preset] button while the preset number and input resolution appear on the screen, otherwise the selection will not change.

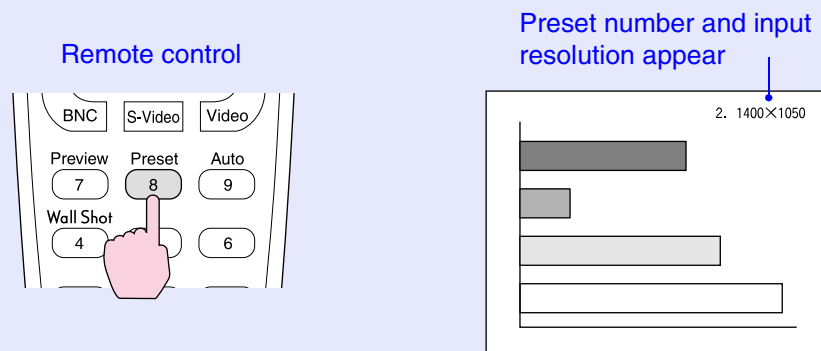

Changing the Resize/Aspect Ratio

When using EasyMP, the display cannot be switched between resized display and real display and the aspect ratio cannot be changed.

■ Selecting the Computer Display Method

When projecting computer images, the display method can be changed between resized display (in which the images are projected so that they fill the available projection area) and real display (in which the images are projected at the resolution of the original input signal).

When projecting computer images, the default method used is resized display.

PROCEDURE

The display method switches between real display and resized display each time the [Resize] button on either the remote control or the projector's control panel is pressed.

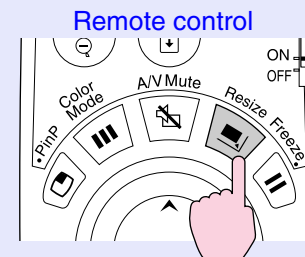

TIP

- Preset numbers that have not yet been preset will be skipped.
- If no preset settings have been made, the message "No Entry" will appear when you press the [Preset] button.





Functions for Enhancing Projection

If the input resolution is lower than the panel resolution (1024 × 768)

Resized display

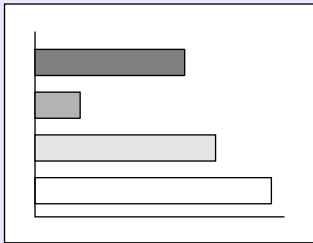

Real display

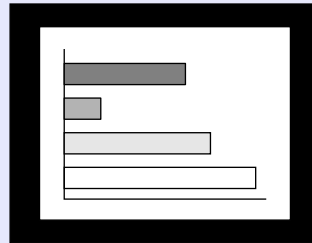

The image is projected in the middle of the screen at the original input signal resolution.

If the input resolution is higher than the panel resolution (1024 × 768)

Resized display

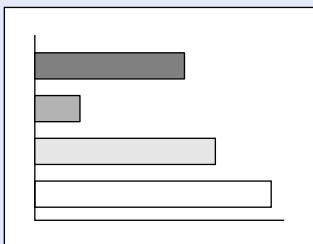

Real display

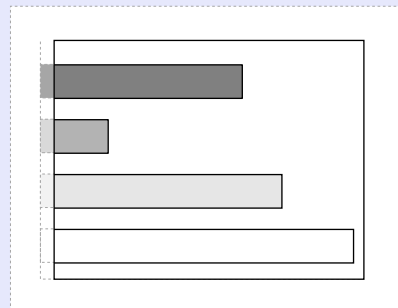

The middle section of the image is projected. You can tilt the [○] button on the remote control to scroll around the image.



TIP

- The display methods for projected images are stored individually for each video source.
- If the input resolution is the same as the panel resolution (1024×768 dots), the image size will not change.
- In the case of SXGA (5:4) input signals, the image position changes as shown below each time you press the [Resize] button while holding down the [Shift] button on the projector's control panel.

Resized display (5:4)

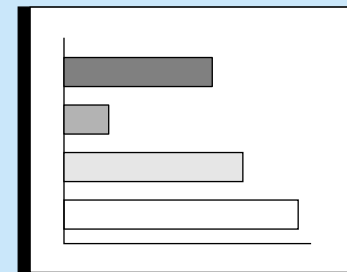

Aligned to left (5:4)

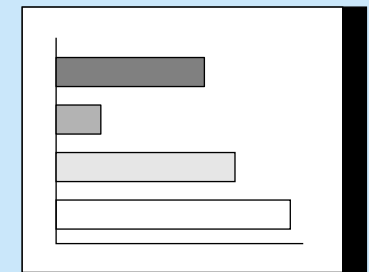

Resized display (4:3)

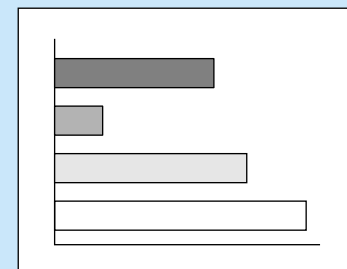

Aligned to right (5:4)

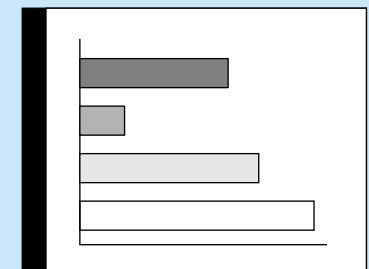



Functions for Enhancing Projection

Projecting Wide-screen Images from Video Equipment

You can switch the [aspect ratio](#) between 4:3 and 16:9 when [component video](#) (YCbCr and YPbPr), [S-Video](#) and [composite video](#) signals are being projected. Images that have been recorded in digital video and DVD images can be projected in 16:9 wide-screen format.

PROCEDURE

The display changes each time you press the [Resize] button on either the remote control or the projector's control panel.

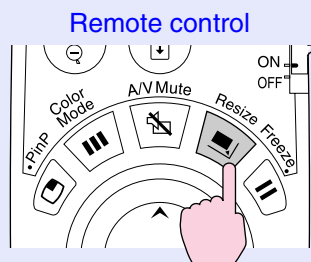

For SDTV

When images that are output in 16:9 format are displayed at an aspect ratio of 4:3, the images are squeezed horizontally so that they appear vertically elongated.

When images in [squeeze mode](#) are projected at 4:3

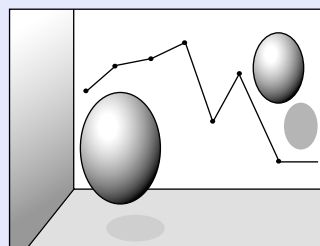

When images in [squeeze mode](#) are projected at 16:9

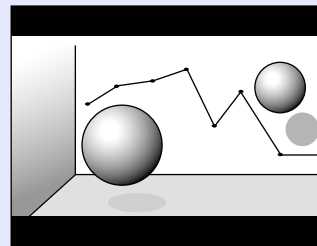

For HDTV

When images that are output in 16:9 format are displayed at an aspect ratio of 4:3, the images are resized so that they fill the full vertical area of the screen, and the left and right edges are truncated and are not displayed.

When images in [squeeze mode](#) are projected at 16:9

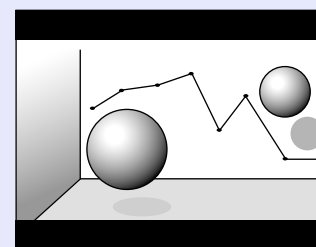

When images in [squeeze mode](#) are projected at 4:3

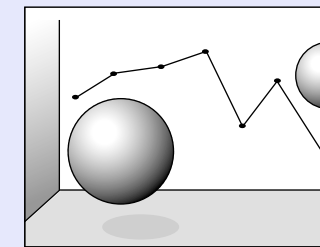

TIP

When projecting images with an aspect ratio of 16:9, the image position will change as follows each time you press the [Resize] button while holding down the [Shift] button on the projector's control panel.

Centre display

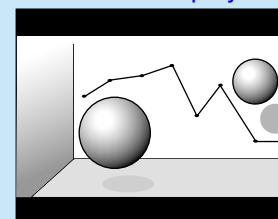

Top edge display

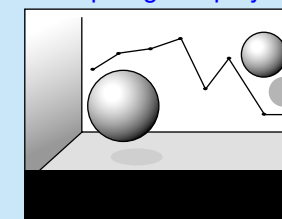

Bottom edge display

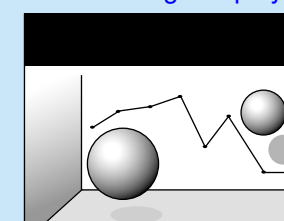



Projector ID/Remote Control ID

If using more than one projector at a time, such as at a show, you can record ID numbers for the projectors and for the remote controls in order to simultaneously operate projectors with the same ID number. Alternatively, if you set the remote control ID to "0", all projectors can be operated by the remote control regardless of the projector ID numbers.



TIP

The default values for ID numbers are "1" for projectors and "0" for remote controls.

Registering an ID Number for a Projector

PROCEDURE

- 1 Press the [Menu] button on either the remote control or the projector's control panel, and then select "Projector ID" from the "Advanced2" menu.

See "Using the Configuration Menus" for details on this operation.

☞ p.92

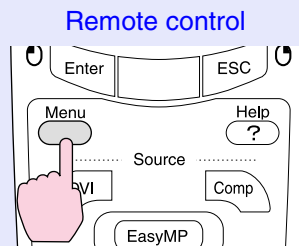

- 2 Use the [◂] button on the remote control or the [◂] or [▶] button on the projector's control panel to select the desired ID number (1–9).

Press the [Enter] button on the remote control or the [Auto/Enter] button on the projector's control panel to accept the ID number setting.

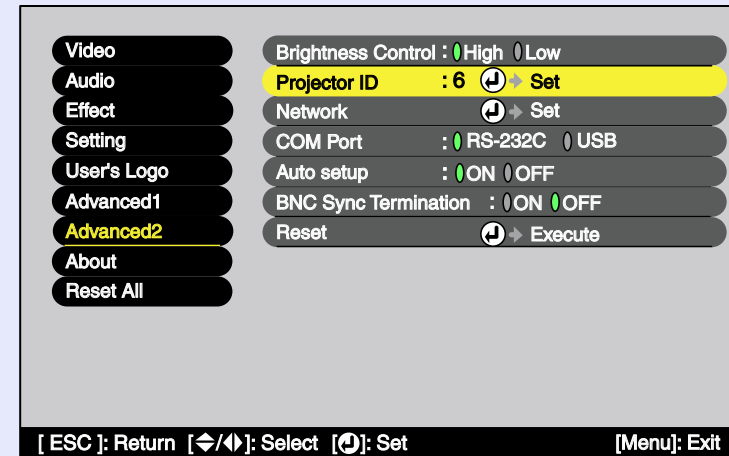

TIP

The numbers that can be used for the "Projector ID" setting are from "1" to "9". "Projector ID" cannot be set to "0".

- 3 Once the setting has been made, press the [Menu] button to close the configuration menu.

When the ID number is registered, the projector cannot be operated by remote control unless the remote control used has the same ID number or has an ID number of "0".



Functions for Enhancing Projection

■ Registering an ID Number for a Remote Control

PROCEDURE

1 Press the [ID] button on the remote control.

The [ID] button will light.

Remote control

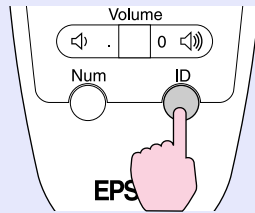

2 Press the [0] to [9] buttons on the remote control to specify the ID number for the remote control.

The light for the [ID] button will turn off and the registration will be complete. If a number other than "0" is registered, the remote control will only be able to operate projectors that have the same ID number.

Remote control

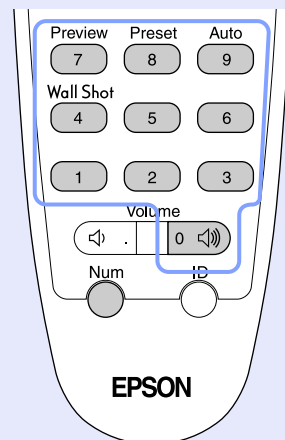

TIP

If you would like to check the ID number that is currently set for a remote control, press the [ID] button on the remote control so that the button lights, and then press the [ID] button once more. After a brief period, the [ID] button will flash, and the number of flashes will equal the remote control's ID number.



Using the Configuration Menu Functions

The configuration menus can be used to carry out a variety of settings and adjustments.

The menus have a hierarchical structure, with a main menu that is divided into sub-menus, which are further divided into other sub-menus.

Refer to "Using the Configuration Menus" (☛ p.92) for details on using the menus.

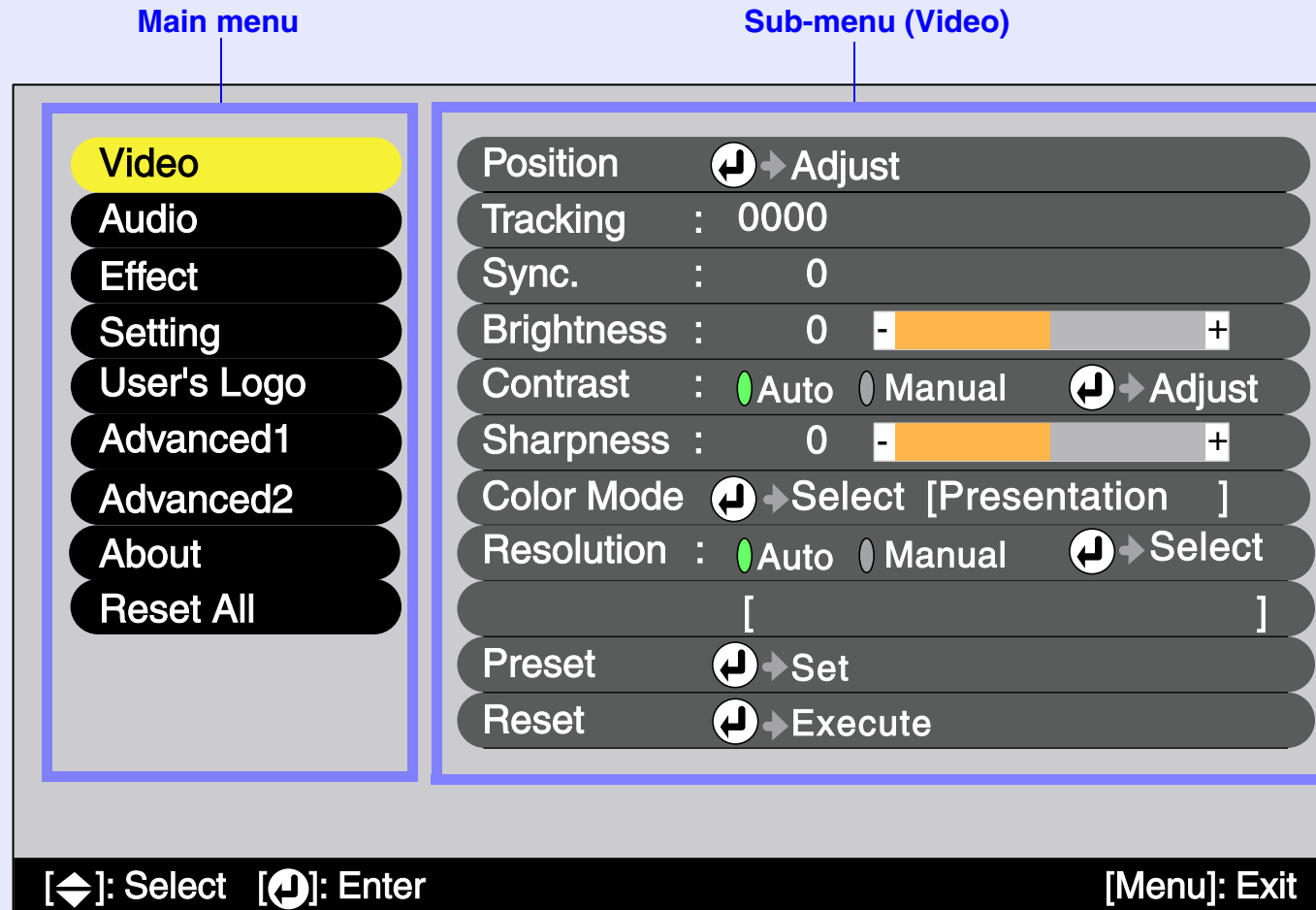



Using the Configuration Menu Functions

List of Functions

"Video" Menu

- The functions in the "Video" menu apart from "Resolution" and "Video Signal" cannot be adjusted while no video signal is being input.
- The functions which appear in the "Video" menu will change depending on the type of input source being projected. Functions which are not available in the "Video" menu for a particular input source cannot be adjusted.

Computer (Analogue RGB)

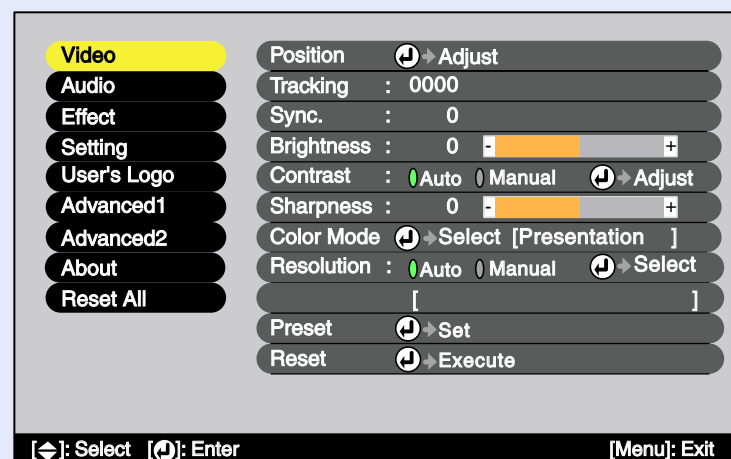

Computer (Digital RGB) / EasyMP

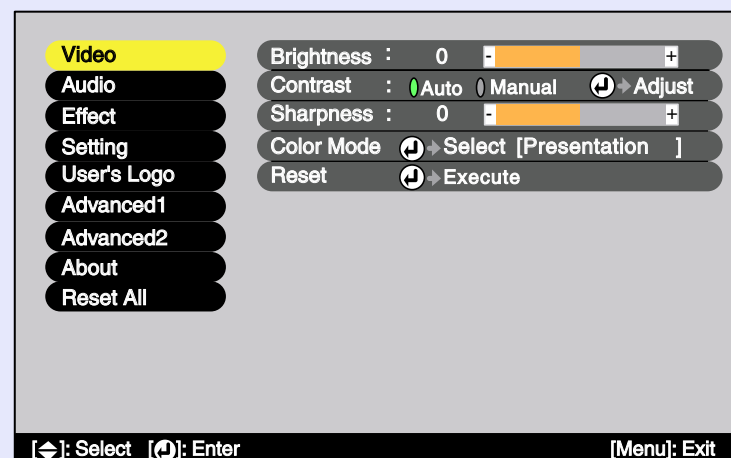

Sub-menu	Function	Default
Position	(Adjustment is only possible when analogue RGB signals are being input) Moves the image display position vertically and horizontally. • Press the [Enter] button on the remote control or the [Auto/Enter] button on the projector's control panel and make the adjustment.	Depends on input signal
Tracking▶▶	(Adjustment is only possible when analogue RGB signals are being input) Adjusts computer images when vertical stripes appear in the images.	Depends on input signal
Sync.▶▶	(Adjustment is only possible when analogue RGB signals are being input) Adjusts computer images when flickering, fuzziness or interference appear in the images. • Flickering and fuzziness may also occur when the brightness, contrast▶▶ , sharpness and keystone correction settings are adjusted. • You can obtain the best results if you adjust the tracking first and then adjust the synchronization.	Depends on input signal
Brightness	Adjusts the image brightness.	Median value (0)
Contrast▶▶	Adjusts the difference between light and shade in the images. • Auto : The contrast is adjusted automatically to the ideal level. • Manual: Contrast is adjusted manually.	Auto
Sharpness	Adjusts the image sharpness.	Median value (0)





Sub-menu	Function	Default
Color Mode	<p>Corrects the vividness of the image colour. The settings can be saved separately for each type of source (computer or video source).</p> <p>You can select from five different quality settings depending on the surroundings.</p> <ul style="list-style-type: none"> •Dynamic : Images are modulated and made fresher to emphasise brightness. •Presentation: Brightness is emphasized. For presentations in bright rooms. •Theatre : Movie images are optimised using natural tints. •Living Room: Brightness is emphasized. Ideal for playing video games in bright rooms. •sRGB▶▶ : Images conform to the sRGB standard. If set to "sRGB", the colour temperature for the "Color Adjustment" command in the "Advanced1" menu will be set to 6500K. 	Presentation
Resolution	<p>(Selection is only possible when analogue RGB signals are being input and are selected)</p> <p>Sets the input resolution for the signal source being used.</p> <ul style="list-style-type: none"> •Auto : The input resolution is set automatically in accordance with the input signal. •Manual: The input resolution is selected manually. 	Auto
Preset	<p>(Recording is only possible when analogue RGB signals are being input)</p> <p>Allows "Video" menu settings to be saved and then applied to analogue RGB images that are being projected by pressing the [Preset] button on the remote control.</p> <ul style="list-style-type: none"> •The current settings are saved when a preset number (1 to 10) is selected. Preset numbers which already have saved settings show the input resolution that has been set. If setting values have been changed, existing settings that have been saved under a preset number can be overwritten by selecting that preset number. 	-

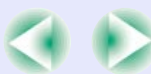



Sub-menu	Function	Default
Reset	Resets all adjustments values for the "Video" menu functions to their default settings. <ul style="list-style-type: none">• Press the [Enter] button on the remote control or the [Auto/Enter] button on the projector's control panel to reset.• Select "Reset All" to reset all menu settings – including settings for the "Video" and "Audio" menus – to their default settings.  p.91	-





Using the Configuration Menu Functions

Component Video» (YCbCr», YPbPr»)

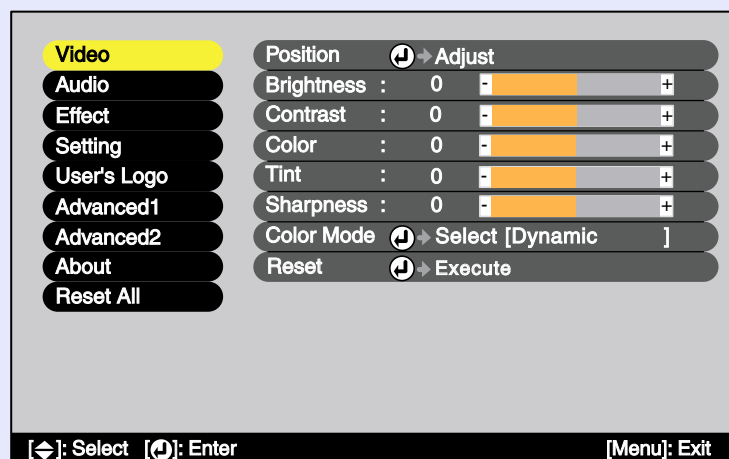

RGB Video

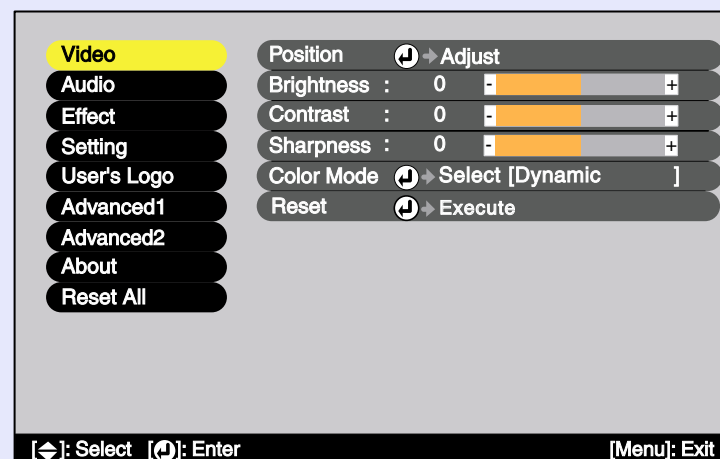

Video (Composite video», S-Video»)

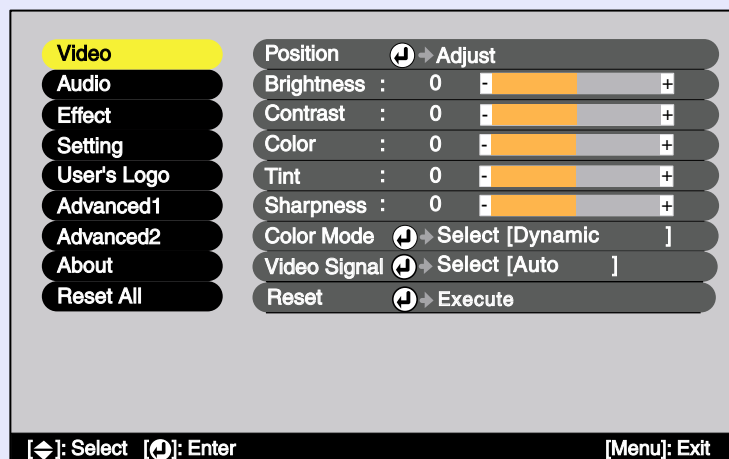

Sub-menu	Function	Default
Position	Moves the image display position vertically and horizontally. •Press the [Enter] button on the remote control or the [Auto/Enter] button on the projector's control panel and make the adjustment.	Depends on input signal
Brightness	Adjusts the image brightness.	Median value (0)
Contrast»	Adjusts the difference between light and shade in the images.	Median value (0)
Color	(Does not appear when the input source is RGB video.) Adjusts the colour intensity for the images.	Median value (0)
Tint	(Does not appear when the input source is RGB video.) Adjusts the image tint.	Median value (0)
Sharpness	Adjusts the image sharpness.	Median value (0)





Sub-menu	Function	Default
Color Mode	<p>Corrects the vividness of the image colour. The settings can be saved separately for each type of source (computer or video source).</p> <p>You can select from five different quality settings.</p> <ul style="list-style-type: none"> •Dynamic : Images are modulated and made fresher to emphasise brightness. •Presentation: Brightness is emphasized. For presentations in bright rooms. •Theatre : Movie images are optimised using natural tints. The black & white extension function operates so that differences in colour gradations (darkness and lightness of colours) are accentuated even for images that are very dark or very bright, to make them easier to view. •Living Room: Brightness is emphasized. Ideal for playing video games in bright rooms. •sRGB : Images conform to the sRGB standard. If set to "sRGB", the colour temperature for the "Color Adjustment" command in the "Advanced1" menu will be set to 6500K. 	Dynamic
Video Signal	<p>(Selection is only possible when composite video/S-Video signals are being input and are selected)</p> <p>Selects the video signal format.</p> <ul style="list-style-type: none"> •Press the [Enter] button on the remote control or the [Auto/Enter] button on the projector's control panel and choose the setting. •When set to "Auto", the video signal format is selected automatically. 	Auto
Reset	<p>Resets all adjustments values for the "Video" menu functions to their default settings.</p> <ul style="list-style-type: none"> •Press the [Enter] button on the remote control or the [Auto/Enter] button on the projector's control panel to reset. •Select "Reset All" to reset all menu settings – including settings for the "Video" and "Audio" menus – to their default settings.  p.91 	-





Using the Configuration Menu Functions

"Audio" Menu

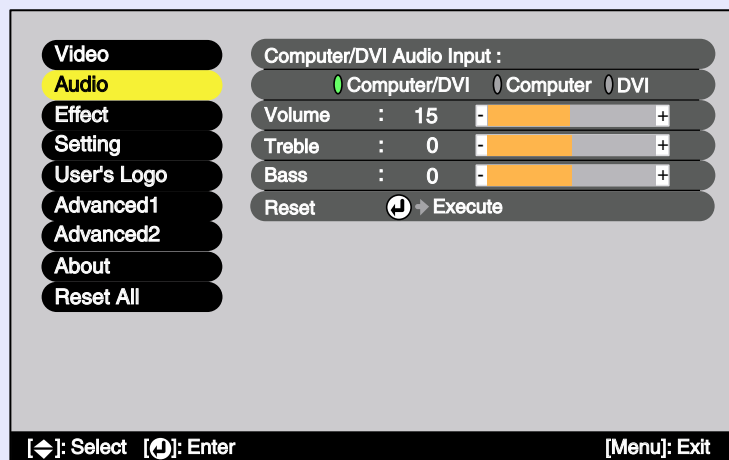

Sub-menu	Function	Default
Computer/ DVI Audio Input	Use this command to specify the [Computer] port or [DVI] port as the video port being used so that sound is input to the associated [Audio] port. <ul style="list-style-type: none"> •Computer/DVI: The sound that are being input are output regardless of the image signal that is selected. •Computer : The [Audio] port only works when images from the [Computer] port are being projected. •DVI : The [Audio] port only works when images from the [DVI] port are being projected. 	Computer/DVI
Volume	Adjusts the volume.	15
Treble	Adjusts the intensity of the treble range.	Median value (0)
Bass	Adjusts the intensity of the bass range.	Median value (0)
Reset	Resets all adjustments values for the "Audio" menu functions to their default settings. <ul style="list-style-type: none"> •Press the [Enter] button on the remote control or the [Auto/Enter] button on the projector's control panel to reset. •Select "Reset All" to reset all menu settings – including settings for the "Video" and "Audio" menus – to their default settings. p.91 	-



TIP





The "Audio" menu settings are saved individually for each input signal source.

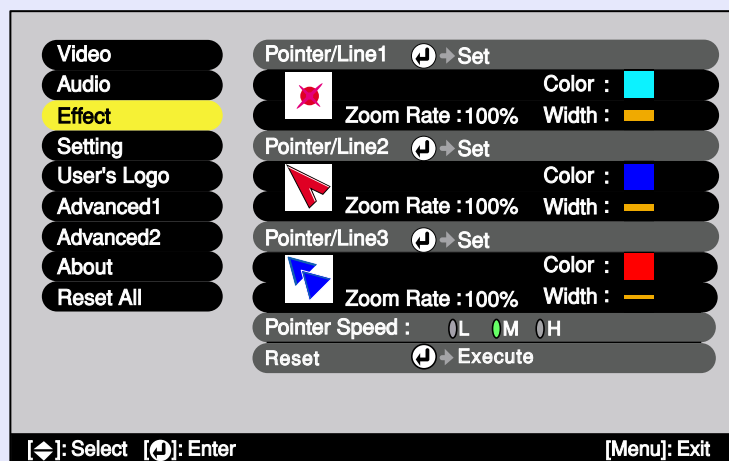

Using the Configuration Menu Functions

■ "Effect" Menu



Sub-menu	Function	Default
Pointer/ Line1	<p>Sets the pointer or line that is displayed when the [Effect] button on the remote control is pressed once.</p> <ul style="list-style-type: none"> • Shape : Select the pointer shape from the following eight types.  <ul style="list-style-type: none"> •Zoom Rate : Select the display size for the pointer icon from "100%" or "200%". •Color : Select the colour of the straight and curved lines from eight colours. •Width : Select the width of the straight and curved lines that are drawn when the pointer icon is moved from Thick, Medium or Thin. 	<p>Shape: </p> <p>Zoom Rate: 100%</p> <p>Color: Light blue</p> <p>Width: Thick</p>
Pointer/ Line2	<p>Sets the pointer or line that is displayed when the [Effect] button on the remote control is pressed twice.</p> <p>The setting items and contents are the same as for "Pointer/Line1".</p>	<p>Shape: </p> <p>Zoom Rate: 100%</p> <p>Color: Blue</p> <p>Width: Medium</p>
Pointer/ Line3	<p>Sets the pointer or line that is displayed when the [Effect] button on the remote control is pressed three times.</p> <p>The setting items and contents are the same as for "Pointer/Line1".</p>	<p>Shape: </p> <p>Zoom Rate: 100%</p> <p>Color: Red</p> <p>Width: Thin</p>
Pointer Speed	<p>Sets the speed at which the pointer moves when the [Effect] button is tilted.</p> <p>L: Low M: Medium H: High</p>	M
Reset	<p>Resets all adjustments values for the "Effect" menu functions to their default settings.</p> <ul style="list-style-type: none"> •Press the [Enter] button on the remote control or the [Auto/Enter] button on the projector's control panel to reset. •Select "Reset All" to reset all menu settings – including settings for the "Video" and "Audio" menus – to their default settings.  p.91 	-



Using the Configuration Menu Functions

■ "Setting" Menu

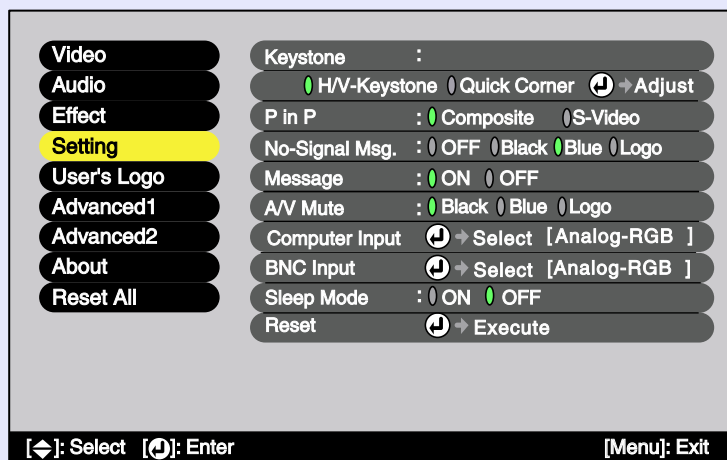

Sub-menu	Function	Default
Keystone	<p>Corrects keystone distortion in images. Press the [Enter] button on the remote control or the [Auto/Enter] button on the projector's control panel, and then make the correction.</p> <p>H/V-Keystone p.47</p> <ul style="list-style-type: none"> •Auto Keystone : This turns the function on and off for detecting the angle of tilt when the projector is tilted vertically and correcting vertical keystone distortion automatically. This function only works when "Rear Proj." or "Ceiling" in the "Advanced1" menu are set to "OFF". If either "Rear Proj" or "Ceiling" is set to "ON", this menu item cannot be selected. •V-Keystone : This function works in the same way as making corrections using the [] and [] buttons on the projector's control panel. It is used to correct vertical keystone distortion in images. •H-Keystone : This function works in the same way as making corrections using the [] and [] buttons on the projector's control panel. It is used to correct horizontal keystone distortion in images. •Height : This correction is used when automatic keystone correction or manual vertical keystone correction make the height of the projected images smaller. <p>Quick Corner p.49</p> <ul style="list-style-type: none"> •Corrects the four corners of the projection area to make the images fit the screen exactly. If the images become uneven in appearance after keystone correction is carried out, adjust using the "Sharpness" command in the "Video" menu. 	<p>Auto Keystone: ON</p> <p>V-Keystone: Median value (0)</p> <p>H-Keystone: Median value (0)</p> <p>Height: Median value (0)</p> <p>Quick Corner: No correction</p>
P in P	<p>When using the P in P function, this selects whether the image signals that are projected into the sub-screen are composite video or S-Video signals.</p>	Composite





Using the Configuration Menu Functions

Sub-menu	Function	Default
No-Signal Msg.	Sets the message status and background colour at times such as when no video signal is being input. When set to "OFF", the background colour becomes black and no message is displayed. <ul style="list-style-type: none"> •To change the user's logo, you need to record your own logo. p.126 	Blue
Message	Selects whether the image signal name or colour mode name is displayed on the screen (ON) or not displayed (OFF) when switching the video signal or colour mode.	ON
A/V Mute	Sets the screen status when the [A/V Mute] button is pressed. p.62 <ul style="list-style-type: none"> •To change the user's logo, you need to record your own logo. p.126 	Black
Computer Input	Selects the input signal for the source that is connected to the [Computer] port.	Analog-RGB
BNC Input	Selects the video signal to match the device that is connected to the [BNC] port.	Analog-RGB
Sleep Mode	Sets the energy saving operation when no video signal is being input. <ul style="list-style-type: none"> •When set to "ON", projection stops automatically and after the cool-down period is finished, the projector changes to sleep mode (standby mode) if no operations are carried out for approximately 30 minutes while the "No-Signal." message is being displayed. (The indicator lights orange.) •Projection starts again when the [Power] button on either the remote control or the projector's control panel is pressed. 	OFF
Reset	Resets all adjustments values for the "Setting" menu functions except for the "Computer Input" and "BNC Input" settings to their default settings. <ul style="list-style-type: none"> •Press the [Enter] button on the remote control or the [Auto/Enter] button on the projector's control panel to reset. •Select "Reset All" to reset all menu settings – including settings for the "Video" and "Audio" menus – to their default settings. p.91 	-





"User's Logo" Menu

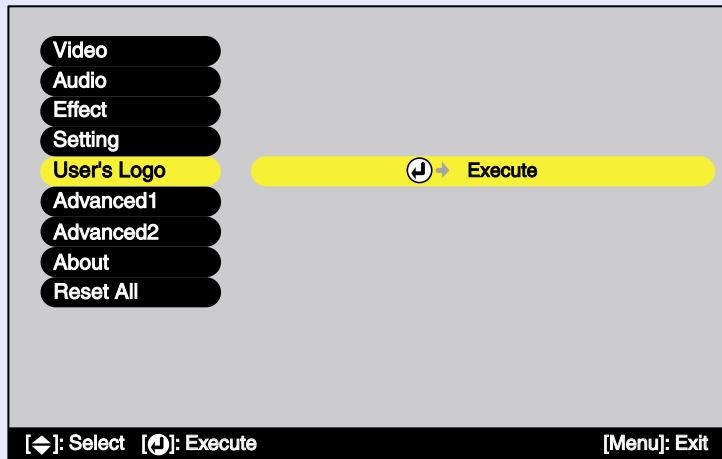

Sub-menu	Function	Default
Execute	Records a user's logo. p.126 <ul style="list-style-type: none"> • Press the [Enter] button on the remote control or the [Auto/Enter] button on the projector's control panel, and then follow the instructions that appear on the screen. 	EPSON logo



Using the Configuration Menu Functions

■ "Advanced1" Menu

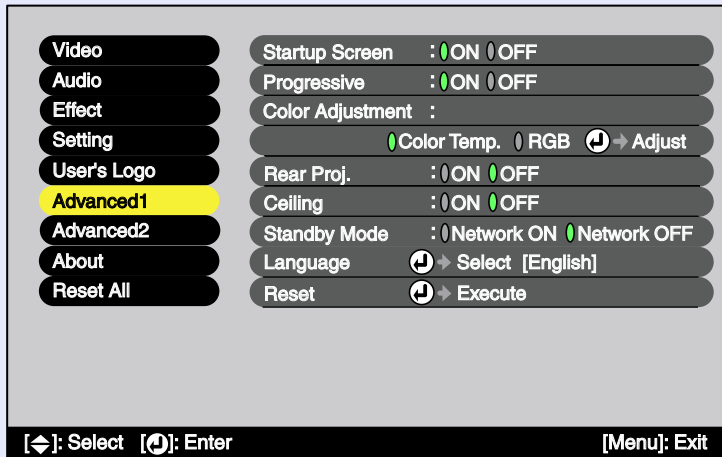

Sub-menu	Function	Default
Startup Screen	Sets whether the startup screen is displayed or not. To change the user's logo, you need to record your own logo. p.126 When this setting is changed, turn the power off, and when the cool-down period has finished, turn the power back on again. The new setting will be applied after the power turns back on.	ON
Progressive	(Setting is only possible when composite video, S-Video or component video (525i, 625i) signals are being input) Converts interlaced (i) signals to progressive (p) signals. When set to "OFF", interlaced signals are projected without conversion. <ul style="list-style-type: none"> •OFF : IP conversion is carried out for each field window. This is ideal for images with a lot of movement. •Video : The film judgment function is turned off. •Film/Auto : This setting is for normal use. The source is automatically judged to be a video source or not, and if it is a video source, the 3-2 pull-down function operates and the images are reproduced as film images with no loss in colour from the original. 	Film/Auto





Sub-menu	Function	Default
Color Adjustment	<p>Adjusts the colour temperature and intensity of each RGB (red, green, blue) colour for each input source.</p> <ul style="list-style-type: none"> •Color Temp.: Lets you adjust bright colours within a range from reddish tinges to bluish tinges. If the colour temperature is lower, colours appear reddish and colour tones appear softer. If the colour temperature is higher, colours appear bluish and colour tones appear sharper. Press the [Enter] button on the remote control or the [Auto/Enter] button on the projector's control panel and make the adjustment. •RGB : Press the [Enter] button on the remote control or the [Auto/Enter] button on the projector's control panel, select "R" (red), "G" (green) or "B" (blue) and make the adjustment. Make the adjustment while viewing the stats of the image on the screen. <p>This item cannot be selected if "sRGB" has been selected as the "Color Mode" setting in the "Video" menu.</p>	Color Temp.: Depends on input signal
Rear Proj.	<p>Use when projecting images from behind a translucent screen.</p> <p>When set to "ON", the projected images are horizontally reversed.</p> <p>When set to "ON", automatic keystone correction is not carried out.</p>	OFF
Ceiling	<p>Use when installing the projector on a ceiling.</p> <p>When set to "ON", the projected images are rotated 180° and horizontally and vertically reversed.</p> <p>When set to "ON", automatic keystone correction is not carried out.</p>	OFF

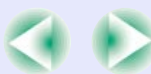



Sub-menu	Function	Default
Standby Mode	Set to "Network ON" to use network monitoring and control functions and the standby monitor out function while the projector is in standby mode. When this setting is changed, turn the power off, and when the cool-down period has finished, turn the power back on again. The new setting will be applied after the power is turned back on.	Network OFF
Language	Sets the language for message displays. •Press the [Enter] button on the remote control or the [Auto/Enter] button on the projector's control panel and choose the setting.	English
Reset	Resets all adjustments values for the "Advanced1" menu functions except for the "Rear Proj.", "Ceiling" and "Language" settings to their default settings. •Press the [Enter] button on the remote control or the [Auto/Enter] button on the projector's control panel to reset. •Select "Reset All" to reset all menu settings – including settings for the "Video" and "Audio" menus – to their default settings. p.91	-





Using the Configuration Menu Functions

■ "Advanced2" Menu

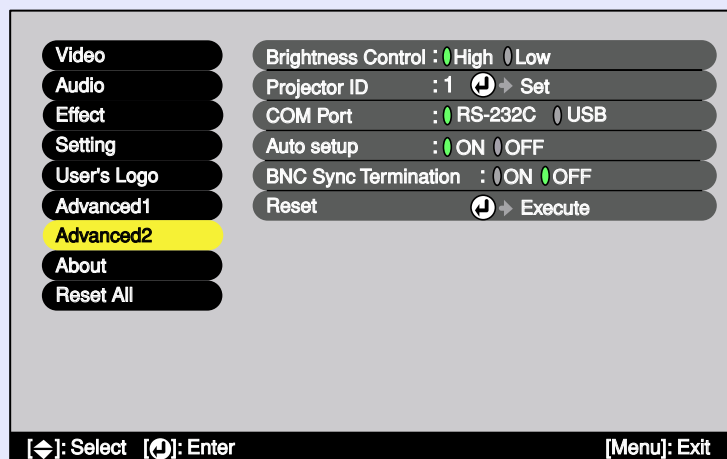

Sub-menu	Function	Default
Brightness Control	This lets you set the lamp brightness to one of two settings. Select "Low" if the images being projected are too bright such as when projecting images in a dark room or onto a small screen. When "Low" is selected, the brightness of the images is reduced, but the amount of electricity consumed and noise produced during projection are reduced and the lamp's operating life is extended.	High
Projector ID	Sets the ID number for the projector. p.73	1
COM Port	This can be set to either "RS-232C" or "USB" depending on the port that is being used for communication with a computer. When this setting is changed, turn the power off, and when the cool-down period has finished, turn the power back on again. The new setting will be applied after the power is turned back on.	RS-232C
Auto Setup	Selects whether the automatic adjustment function for automatically optimising images when the input source is switched to computer analogue images.	ON
BNC Sync Termination	Sets the termination mode for the [BNC] port. This is used for image terminal processing. •ON : Analogue (75 Ω) termination •OFF: TTL (Normal signal level output by the computer) input This should normally be set to "OFF". If an analogue (75 Ω) termination such as for a switcher is required, change the setting to "ON".	OFF
Reset	Resets all adjustment values for the "Advanced2" menu to their default settings, except for the "Projector ID" setting. •Press the [Enter] button on the remote control or the [Auto/Enter] button on the projector's control panel to reset. •Select "Reset All" to reset all menu settings – including settings for the "Video" and "Audio" menus – to their default settings. p.91	-



Using the Configuration Menu Functions

"About" Menu

- The "About" menu shows the setting details for the current input signal.
- The "Lamp" item appears as "0H" for 0–10 hours, and after that it appears in units of 1 hour.

Computer (Analogue RGB, Digital-RGB)/
[Component Video](#) (YCbCr, YPbPr)/
 RGB Video

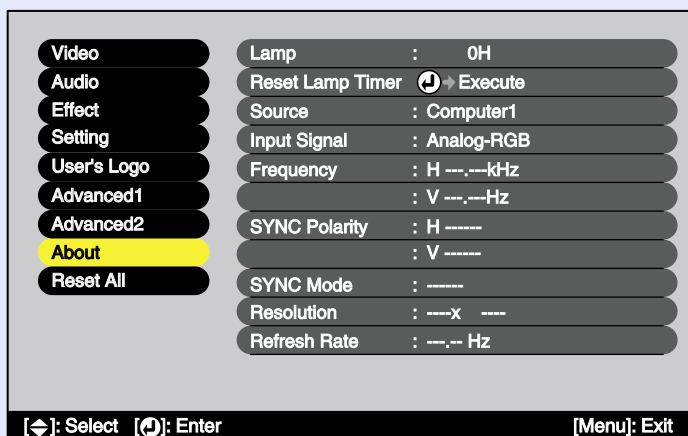

Video ([Composite Video](#), [S-Video](#))

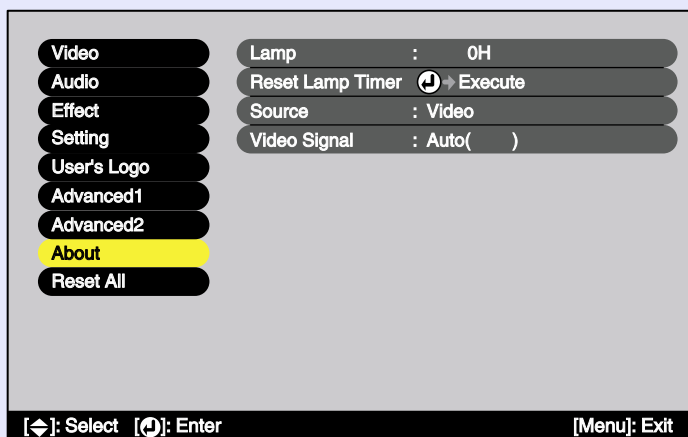

EasyMP

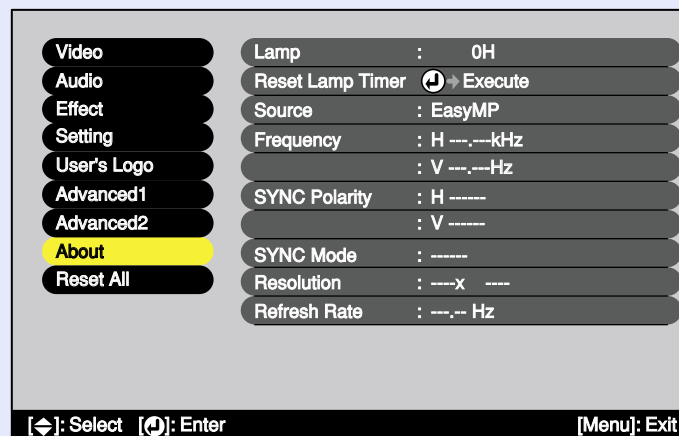

Sub-menu	Function	Default
Lamp	Displays the cumulative lamp operating time. •When the lamp warning period is reached, the display characters appear in red.	0H
Reset Lamp Timer	Initialises the lamp operating time. When this command is selected, the cumulative lamp operating time is reset to the initial default value.	-
Source	Displays the input source which is currently being projected.	
Input Signal	Displays the input signal settings. (Does not appear when the input source is composite video, S-video, or EasyMP.)	
Video Signal	Shows the video signal format. (Does not appear when the input source is a computer, component video, RGB video, or EasyMP.)	-
Frequency	Displays the horizontal and vertical scanning frequencies. (Does not appear when the input source is composite video or S-video.)	-
SYNC Polarity	Displays the sync polarity. (Does not appear when the input source is composite video or S-video.)	-





Using the Configuration Menu Functions

Sub-menu	Function	Default
SYNC Mode	Displays the sync attributes. (Does not appear when the input source is composite video or S-video.)	-
Resolution	Displays the input resolution. (Does not appear when the input source is composite video or S-video.)	-
Refresh Rate ▶	Displays the refresh rate. (Does not appear when the input source is composite video or S-video.)	-

■ "Reset All" Menu

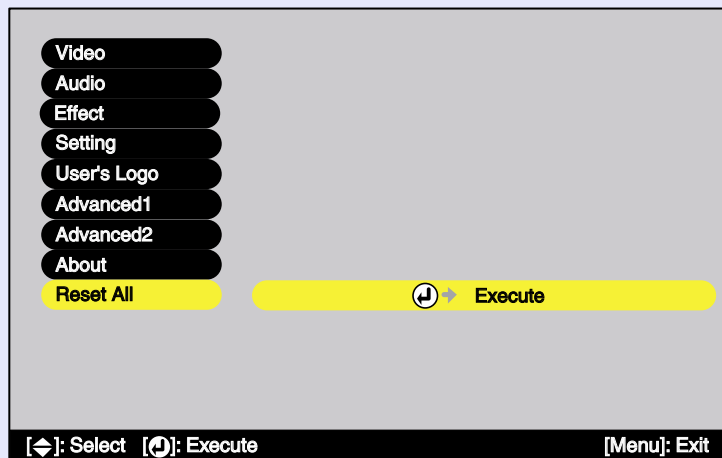

Sub-menu	Function	Default
Execute	Resets all items in all configuration menus to their default settings. <ul style="list-style-type: none"> • Press the [Enter] button on the remote control or the [Auto/Enter] button on the projector's control panel to reset. • Select "Reset" in an individual sub-menu such as the "Video" or "Audio" menu to reset only the settings for the items in each sub-menu. • This function will not reset the "Computer Input", "BNC Input", "User's Logo", "Language", "Projector ID", and "Lamp" settings. 	-





Using the Configuration Menu Functions

Using the Configuration Menus

The configuration menus can be operated using either the remote control or the projector's control panel.

PROCEDURE

1 Press the [Menu] button on either the remote control or the projector's control panel.

The main configuration menu appears.

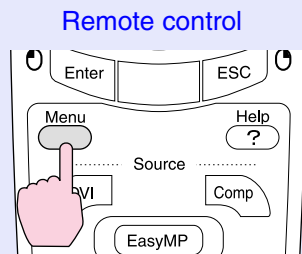

2 Select a main menu item.

If using the remote control, tilt the [⊙] button up or down to select a menu item.

If using the projector's control panel, press the [△] or [▽] button to select a menu item.

The sub-menu items vary depending on the item selected in the main menu.

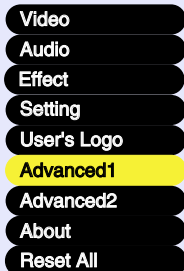

3 Confirm the selection.

If using the remote control, press the [Enter] button to confirm a selection.

If using the projector's control panel, press the [Auto/Enter] button to confirm a selection.

The cursor will be displayed in the sub-menu and settings can then be made.

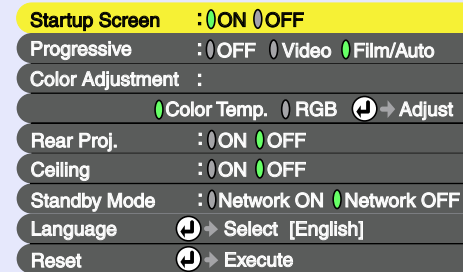

4 Select a sub-menu item.

If using the remote control, tilt the [⊙] button up or down to select a sub-menu item.

If using the projector's control panel, press the [△] or [▽] button to select a sub-menu item.

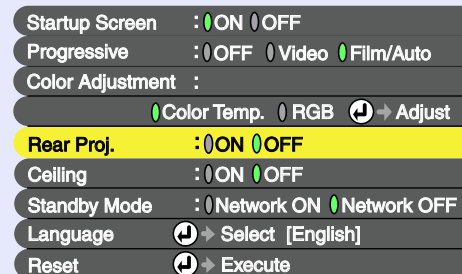



Using the Configuration Menu Functions



TIP

The items appearing in the "Video" menu and the "About" menu will vary depending on the type of input source being projected.

5 Select a setting value.

Tilt the [○] button on the remote control or press the [◀] or [▶] button on the projector's control panel to change setting values. For items which are currently set, a ● appears in green next to the setting. If you tilt the [○] button on the remote control or press the [◀] or [▶] button on the projector's control panel to select an item to be set, the ● will appear in orange. After making the selection, press the [Enter] button on the remote control or the [Auto/Enter] button on the projector's control panel to accept the setting. When the setting is accepted, the ● changes to green.

Startup Screen	: ON OFF
Progressive	: OFF Video Film/Auto
Color Adjustment	: Color Temp. RGB Adjust
Rear Proj.	: ON OFF
Ceiling	: ON OFF
Standby Mode	: Network ON Network OFF
Language	: Select [English]
Reset	: Execute



TIP

- Sub-menu items which cause another sub-menu to be displayed when they are selected have ☺ after them. If you select such menu items and press the [Enter] button on the remote control or the [Auto/Enter] button on the projector's control panel, you can then change the settings in the next sub-menu which appears.
- Refer to "List of Functions" for details on the functions of each menu item. ➡ p.76

6

Select other menu items in the same way.

Repeat steps 2 to 5 to change the settings for other menu items. To return to a previous menu, press the [ESC] button on either the remote control or the projector's control panel.

7

Close the menu.

Press the [Menu] button on either the remote control or the projector's control panel.



TIP

The display position for configuration menus can be set to either the top-left or the bottom-right of the images. If you press the [Menu] button on either the remote control or the projector's control panel twice in succession when displaying a configuration menu, the configuration menu will be displayed in a different position from before. If you would like to change configuration menu settings while checking images, select an appropriate point in the projection and then display the configuration menu.





Troubleshooting

This chapter describes how to identify problems and what to do if a problem is found.

Using the Help.....	95
Problem Solving.....	97
• Reading the Indicators.....	97
• When the Indicators Provide No Help	100
• Problems relating to images	101
• Other problems	106
• Problems relating to monitoring and controlling projectors using a network	107
• An error message is displayed.....	114

Using the Help



If a problem occurs with the projector, the Help function uses on-screen displays to assist you in solving the problem. It uses a series of menus in a question and answer format.

PROCEDURE

- 1 Press the [Help] button on either the remote control or the projector's control panel.

The help menu will be displayed.

Remote control

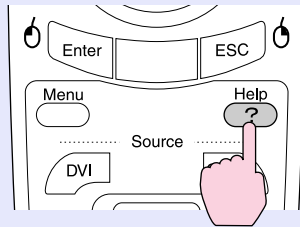

- 2 Select a menu item.

If using the remote control, tilt the [⊙] button up or down to select a menu item.

If using the projector's control panel, press the [▲] or [▼] button to select a menu item.

Remote control

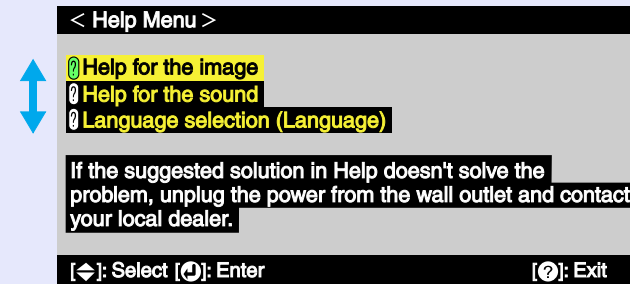
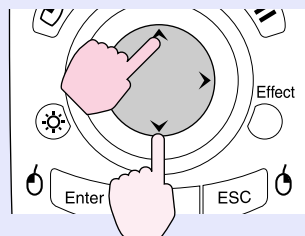

- 3 Confirm the selection.

Press the [Enter] button on the remote control or the [Auto/Enter] button on the projector's control panel to confirm a selection.

Remote control

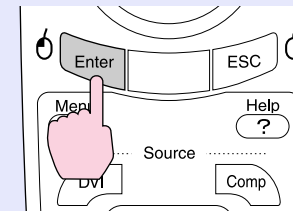

TIP

To return to a previous menu, press the [ESC] button on either the remote control or the projector's control panel.





4 Repeat steps 2 and 3 to proceed through the menu to more detailed items.

The help menu is cleared when the [Help] button is pressed.

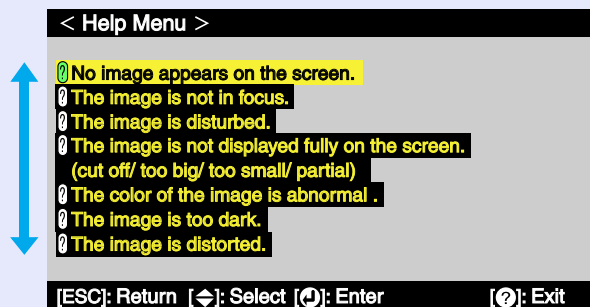

TIP

If the Help function does not provide a solution to the problem, refer to "Problem Solving". [p.97](#)





If you are having a problem with the projector, first check the projector's indicators while referring to "Reading the Indicators" below. If the indicators do not show clearly what the problem might be, refer to "When the Indicators Provide No Help". p.100

Reading the Indicators

The projector is provided with the following three indicators. These indicators notify you of the operating status of the projector.

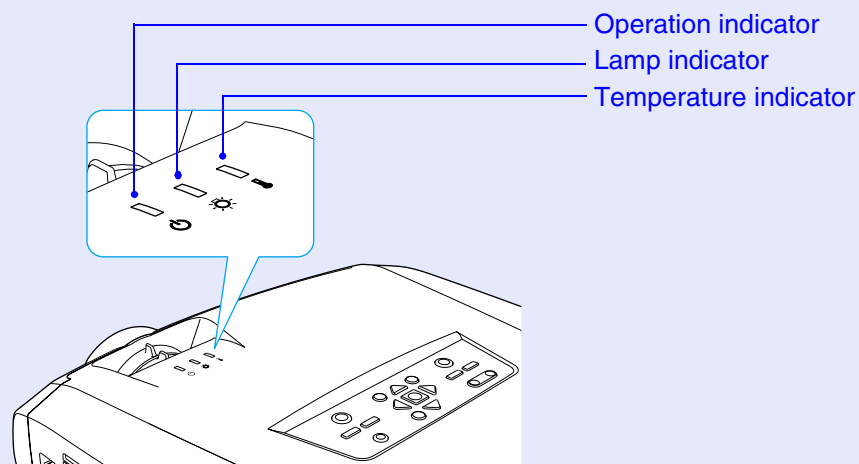

The following tables show what the indicators mean and how to remedy the problems that they indicate.

: lit : flashing : off

Status	Cause	Remedy or Status
Red Red Red 	Internal error	Stop using the projector, disconnect the power cable from the electrical outlet, and contact your dealer or the nearest address provided in the "International Warranty Conditions" section of the <i>Safety Instructions/World-Wide Warranty Terms</i> booklet.
Red Red 	Fan related error Sensor error	Stop using the projector, disconnect the power cable from the electrical outlet, and contact your dealer or the nearest address provided in the "International Warranty Conditions" section of the <i>Safety Instructions/World-Wide Warranty Terms</i> booklet.









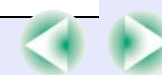





















: lit : flashing : off

Status	Cause	Remedy or Status
<p>Red Red </p> <p> </p> <p> </p>	<p>Lamp cover is open error Lamp timer failure Lamp out</p>	<p>Take out the lamp and check if it is broken. Replacing the Lamp p.121 If the lamp is not broken, put it back in and then turn the power on. If the lamp still does not turn on, replace it with a new lamp. If this does not solve the problem, stop using the projector and disconnect the power cable from the electrical outlet. Then contact your dealer or the nearest address provided in the "International Warranty Conditions" section of the <i>Safety Instructions/World-Wide Warranty Terms</i> booklet.</p> <hr/> <p>If the lamp is broken. Contact your local dealer for further advice. (Projection cannot be carried out until the lamp is replaced.)</p> <hr/> <p>Check that the lamp and the lamp cover are securely installed. If the lamp or lamp cover is not securely installed, the lamp will not switch on.</p>
<p>Red Red</p> <p> </p> <p> </p>	<p>Internal temperature error (overheating)</p>	<p>The lamp will turn off automatically and projection will stop. Wait for about 5 minutes without operating the projector. After about 5 minutes have elapsed, unplug the power cable and then check the following two points.</p> <ul style="list-style-type: none"> •Check that the air filter and air exhaust vent are clear, and that the projector is not positioned against a wall. p.15 •If the air filters are blocked, clean or replace them. p.119 <p>When the power cable is plugged back in, the projector will return to its previous state, so press the [Power] button on either the projector's control panel or the remote control to turn it back on. If the projector continues to overheat even after the above points have been checked, or if the indicators show a problem when the power is turned back on, stop using the projector, disconnect the power cable from the electrical outlet, and contact your dealer or the nearest address provided in the "International Warranty Conditions" section of the <i>Safety Instructions/World-Wide Warranty Terms</i> booklet.</p>
<p>Red Orange</p> <p> </p> <p> </p>	<p>High-speed cooling in progress</p>	<p>(This is not an abnormality, However, if the temperature rises too high again, projection will stop automatically.)</p> <ul style="list-style-type: none"> •Check that the air filters and air exhaust vent are clear and that they are not up against a surface such as a wall. p.15 •If the air filters are blocked, clean or replace them. p.119
<p> Orange </p> <p> </p> <p> </p>	<p>Lamp replacement notification</p>	<p>Replace the lamp with a new one. p.121 If you continue to use the lamp after it has passed the replacement period, the possibility that the lamp may break will increase. Replace the lamp with a new one as soon as possible. *The indicator status will vary depending on the projector status at the time.</p>





 : lit  : flashing  : off

Status	Cause	Remedy or Status
Orange      	Standby condition	(Not abnormal) Press the [Power] button on either the remote control or the projector's control panel to start projection. When turning off the projector's power, disconnect the power plug from the electrical outlet when the projector is in this condition.
Green      	Warm-up in progress	(Not abnormal) Please wait. Warm-up time is approximately 40 seconds. After warm-up is complete, the flashing green indicator changes to steady green.
Green      	Projection in progress	(Not abnormal)
Orange      	Cool-down in progress	(Not abnormal) Please wait. <ul style="list-style-type: none"> •The cool-down period lasts about 30 seconds. (This varies depending on factors such as the ambient air temperature.) •You cannot operate the [Power] button on either the remote control or the projector's control panel during cool-down. Press the button again after cool-down ends and the indicator changes to steady orange.

When no indicators are lit, the power supply cable is not properly connected, or electricity is not being supplied.

TIP

- If the projector is not operating properly even though the indicators are all showing normal, refer to "When the Indicators Provide No Help".
- If an indicator is showing a status which does not appear in the previous tables, contact your dealer or the nearest address provided in the "International Warranty Conditions" section of the Safety Instructions/World-Wide Warranty Terms booklet.





When the Indicators Provide No Help

First refer to the following problems to determine what type of problem it is that you are having, and then refer to the page containing details of the problem.

Problems relating to images

- No images appear [p.101](#)
Projection does not start, the projection area is completely black, the projection area is completely blue, etc.
- Projection stops automatically [p.101](#)
- The message "Not Supported." is displayed. [p.102](#)
- The message "No Signal." is displayed. [p.102](#)
- Images are fuzzy or out of focus. [p.103](#)
- Interference or distortion appear in images. [p.103](#)
Problems such as interference, distortion or black & white checked patterns appear.
- Image is truncated (large) or small [p.104](#)
Only part of the image is displayed.
- Image colours are not right [p.105](#)
The whole image appears purplish or greenish, images are black & white, colours appear dull, etc.
(Computer monitors and LCD screens have different colour reproduction performance, so that the colours projected by the projector and the colours appearing on the monitor may not necessarily match, but this is not a sign of a problem.)
- Images appear dark [p.106](#)

Other problems

- No sound can be heard or the sound is faint [p.106](#)
- The remote control does not work [p.107](#)

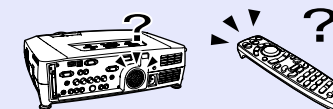

Problems relating to networks and EasyMP

- Mail notification messages are not being sent when a problem occurs with the projector. [p.107](#)
- The projector cannot be monitored and controlled using the EMP Monitor function. [p.108](#)
- You cannot connect from another computer when images are being projected during a network connection [p.109](#)
- EMP NS Connection starts, but a projector is not found [p.110](#)
- Connection cannot be established in Access point mode or wired LAN connection mode [p.111](#)
- Connection cannot be made in Ad hoc mode [p.112](#)
- Network Screen images are not displayed, or the display is slow [p.112](#)
- PowerPoint slideshows will not play back in Network Screen [p.112](#)
- Network Screen cannot be used [p.113](#)
- Files do not work correctly with EMP SlideMaker2. [p.113](#)
- An error message is displayed [p.114](#)

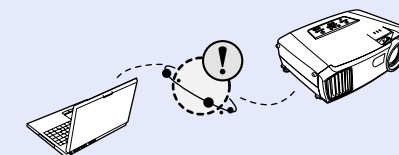



Problem Solving

■ Problems relating to images

■ No images appear

Check	Remedy
Was the [Power] button pressed?	Press the [Power] button on either the remote control or the projector's control panel to turn the power on. The remote control cannot be used unless the [R/C] switch of the remote control is at "ON". ☞ p.36
Is the A/V Mute function active?	Press the [A/V Mute] button on either the remote control or the projector's control panel to cancel the A/V Mute function. ☞ p.62
Has "No-Signal Msg." been set to "OFF"?	If the "No-Signal Msg." menu command has been set to "OFF", set it to "Black" or "Blue" for messages to be displayed. If a message is displayed, refer to the item indicated. ☞ "Setting" - "No-Signal Msg." p.84
Have the configuration menu settings been made correctly?	Reset all of the settings. ☞ p.91
Is the projected image completely black? Only when projecting computer images	Some input images, such as screen savers, may be completely black.
Are the image signal format settings correct? Only when projecting images from a video source	If a composite video or S-Video source is connected to the projector, use the "Video Signal" menu command to select the signal format. ☞ "Video" - "Video Signal" p.80

■ Projection stops automatically

Check	Remedy
Is "Sleep Mode" set to "ON"?	When the "Sleep Mode" menu command has been set to "ON", the lamp turns off automatically if no operations are carried out for about 30 minutes while no video signal is being input. The ⏻ indicator lights orange at this time. Press the [Power] button on either the remote control or the projector's control panel to turn the power on. If you do not want sleep mode to be used, change the "Sleep Mode" setting to "OFF". ☞ "Setting" - "Sleep Mode" p.84



Problem Solving

- The message "Not Supported." is displayed.

Check	Remedy
Are the image signal format settings correct?	If the signal from the video source which is connected to the [BNC] ports of the projector is being projected, use the "BNC Input" menu command to select the signal format which matches the connected signal source. 🖱️ "Setting" - "BNC Input" p.84 If a composite video or S-Video source is connected to the projector, use the "Video Signal" menu command to select the signal format. 🖱️ "Video" - "Video Signal" p.80
Does the mode match the frequency and resolution of the image signals?	Use the "Frequency" menu command to check the signals being input. 🖱️ "About" - "Frequency" p.90 Check the frequency and resolution of the computer. 🖱️ Computer documentation
Only when projecting computer images	

- The message "No Signal." is displayed.

Check	Remedy
Are the cables connected correctly?	Check that all of the cables required for projection are securely connected. 🖱️ p.19–p.30
Has the correct video input port been selected?	Press the [Source] button on either the remote control or the projector's control panel to change the image source. 🖱️ p.37
Is the power for the computer or video source turned on?	Turn the power on for the devices. 🖱️ p.36
Are the image signals being output to the projector?	If the image signals are only being output to the computer's LCD monitor or to the accessory monitor, you need to change the output to an external destination as well as the computer's own monitor. For some computer models, when the image signals are output externally, they no longer appear on the LCD monitor or accessory monitor. 🖱️ Computer documentation, under a title such as "External output" or "Connecting an external monitor" If the connection is made while the power is already turned on, the function [Fn] key that switches the computer's video signal to external output may not work. Turn the power for the projector and the computer off and then back on again. 🖱️ p.36, p.40
Only when projecting images from a laptop computer or computer with a built-in LCD screen	



Problem Solving

■ Images are fuzzy or out of focus.

Check	Remedy
Has the focus been adjusted correctly?	Turn the focus ring on the projector to adjust the focus. p.42
Is the lens cover still attached?	Remove the lens cover. p.35
Is the projector at the correct distance?	The recommended projection distance range is 77–1113 cm. Set the projector up so that it is within this range. p.15
Is the keystone adjustment value too large?	Decrease the projection angle to reduce the amount of keystone correction. p.45
Has condensation formed on the lens?	If the projector is suddenly taken from a cold environment to a warm environment or if sudden ambient temperature changes occur, condensation may form on the surface of the lens, and this may cause the images to appear fuzzy. Set the projector up in the room approximately one hour before it is to be used. If condensation forms on the lens, turn the power off and wait for the condensation to disappear.

■ Interference or distortion appears in images.

Check	Remedy
Are the image signal format settings correct?	If a video source is connected to the [BNC] ports of the projector, use the "BNC Input" menu command to select the signal format which matches the connected signal source. "Setting" - "BNC Input" p.84 If a composite video or S-Video source is connected to the projector, use the "Video Signal" menu command to select the signal format. "Video" - "Video Signal" p.80
Are the cables connected correctly?	Check that all of the cables required for projection are securely connected. p.19–p.30
Is an extension cable being used?	If an extension cable is used, electrical interference may affect the signals. Use the accessory cables and check if this helps.
Has the correct resolution been selected? Only when projecting computer images	Set the computer so that the signals that are output are compatible with this projector. "List of Supported Monitor Displays" p.136 Computer documentation
Have the "Sync" and "Tracking" settings been adjusted correctly? Only when projecting computer images	Press the [Auto] button on the remote control or the [Auto/Enter] button on the projector's control panel to carry out automatic adjustment. If the images have not been adjusted correctly after using automatic adjustment, you can make the adjustments using the "Sync" and "Tracking" menus. p.54 , p.55



■ Image is truncated (large) or small

Check	Remedy
<p>Is the image in real display? Is the aspect ratio setting correct?</p>	<p>Press the [Resize] button on either the remote control or the projector's control panel. p.70</p>
<p>Is the image still being enlarged by the E-Zoom function?</p>	<p>Press the [ESC] button on the remote control to cancel the E-Zoom function. p.63</p>
<p>Has the "Position" setting been adjusted correctly?</p>	<p>If analogue RGB computer signals are being input, press the [Auto] button on the remote control or the [Auto/Enter] button on the projector's control panel to automatically adjust the setting. If the images have not been correctly adjusted after using the automatic setup function, adjust the setting manually using the "Position" menu command. If signals other than analogue RGB computer signals are being input, adjust the setting manually using the "Position" menu command. "Video" - "Position" p.76, p.79</p>
<p>Has the computer been set for dual display? Only when projecting computer images</p>	<p>If dual display has been activated in the Display Properties of the computer's Control Panel, the projector will only project about half of the image on the computer screen. To display the whole of the image on the computer screen, turn off the dual display setting. Computer video driver documentation</p>
<p>Has the "Resolution" command been set correctly? Only when projecting computer images</p>	<p>Set the "Resolution" menu command to match the computer. "Video" - "Resolution" p.77 Computer documentation</p>



■ Image colours are not right

Check	Remedy
<p>Do the input signal settings match the signals from the connected device?</p>	<p>If the "BNC Input" menu command has been set to "YCbCr" or "YPbPr" when a computer or RGB video source is connected to the [BNC] ports of the projector, the images will appear purplish. If the "BNC Input" menu command has been set to "Analog-RGB" when a component video signal source is connected to the [BNC] ports of the projector, the images will appear greenish. Select the correct signal format for the connected source. 🖱️ "Setting" - "BNC Input" p.84 If a composite video or S-Video source is connected to the projector, use the "Video Signal" menu command to select the video signal format. 🖱️ "Video" - "Video Signal" p.80</p>
<p>Has the image brightness been adjusted correctly?</p>	<p>Use the "Brightness" menu command to adjust the brightness. 🖱️ "Video" - "Brightness" p.76, p.79</p>
<p>Are the cables connected correctly?</p>	<p>Check that all of the cables required for projection are securely connected. 🖱️ p.19–p.30</p>
<p>Has the image contrast been adjusted correctly?</p>	<p>Use the "Contrast" menu command to adjust the contrast. 🖱️ "Video" - "Contrast" p.76, p.79</p>
<p>Has the colour been adjusted correctly?</p>	<p>Use the "Color Adjustment" menu command to adjust the colour. "Advanced1" - "Color Adjustment" 🖱️ p.87</p>
<p>Has the Wall Shot function been set to "Wall Shot ON"?</p>	<p>When projecting onto a normal screen, press the [Wall Shot] button on either the remote control or the projector's control panel to change the setting to "Wall Shot OFF". To re-adjust the Wall Shot setting, use "Wall Shot Readjustment". 🖱️ p.52</p>
<p>Have the colour intensity and tint been adjusted correctly?</p> <p>Only when projecting images from a video source</p>	<p>Use the "Color" and "Tint" menu commands to adjust the colour and tint. 🖱️ "Video" - "Color", "Tint" p.79</p>



Problem Solving

■ Images appear dark

Check	Remedy
Have the image brightness and luminance been adjusted correctly?	Use the "Brightness" and "Brightness Control" menu commands to adjust the brightness and luminance. ☛ "Video" - "Brightness" p.76, p.79 ☛ "Advanced2" - "Brightness Control" p.89
Has the image contrast been adjusted correctly?	Use the "Contrast" menu command to adjust the contrast. ☛ "Video" - "Contrast" p.76, p.79
Is the lamp due for replacement?	When the lamp is nearly due for replacement, the images will become darker and the colour quality will become poorer. When this happens, the lamp should be replaced with a new one. ☛ p.121

■ Other problems

■ No sound can be heard or the sound is faint

Check	Remedy
Is the audio source connected correctly?	Check that the cable is connected to the correct "Audio" port. ☛ p.31
Has the volume been adjusted to the minimum setting?	Adjust the volume so that sound can be heard. ☛ "Audio" - "Volume" p.57
Is an audio cable still connected to the projector's [Audio Out] port?	If a cable connector is inserted into the [Audio Out] port, sound is no longer output from the projector's built-in speaker. If not using external speakers, disconnect the audio cable from the [Audio Out] port.
Is the A/V Mute function active?	Press the [A/V Mute] button on either the remote control or the projector's control panel to cancel the A/V Mute function. ☛ p.62
Is the "Computer/DVI Audio Input" setting correct?	Change the "Computer/DVI Audio Input" setting in the "Audio" menu to match the images being projected, or set it to "Computer/DVI". ☛ p.81



■ The remote control does not work

Check	Remedy
Is the [R/C] switch at the "ON" position?	Set the [R/C] switch to the "ON" position. p.36
Is the remote control light-emitting area facing towards the remote control light-receiving area when it is operated?	Face the remote control towards the remote control light-receiving area. The operating angle for the remote control is approximately $\pm 30^\circ$ horizontally and approximately $\pm 15^\circ$ vertically. p.13
Is the remote control too far from the projector?	The operating range for the remote control is approximately 10 m. p.13 If operating the remote control from a distance or if you would like to ensure that remote control operations work properly, use the optional remote control cable kit. p.129
Is direct sunlight or strong light from fluorescent lamps shining onto the remote control light-receiving area?	Set the projector up in a location where strong light will not shine onto the remote control light-receiving area.
Are the batteries dead, or have the batteries been inserted correctly?	Insert new batteries, while making sure that they face correctly. p.11
Does the remote control's ID number match the projector's ID number?	If the remote control's ID number is set to a number other than "0", the ID number must match the projector's ID number, otherwise the remote control will not work. p.73
Is the remote control cable still connected to the [Remote] port of either the remote control or the projector?	If the remote control cable is still connected to the [Remote] port, the remote control light-receiving areas of the projector or the remote control light-emitting area of the remote control will not work. If not using the remote control cable kit, disconnect the remote control cable from the [Remote] port of either the remote control or the projector.

■ Problems relating to monitoring and controlling projectors using a network

■ Mail notification messages are not being sent when a problem occurs with the projector.

Check	Remedy
Is the projector computer correctly connected to the network?	Check that the network cable is properly connected. If the cable is not connected, or is incorrectly connected, please connect it properly. p.18
Are the settings for connecting to a network correct?	Check the Network advanced settings. "Connecting in Access Point Mode or Wired LAN Connection Mode" in the <i>EasyMP Setup Guide</i>
Has "Standby Mode" been set to "Network ON"?	If using the mail notification function while the projector is in standby mode, change the "Standby Mode" menu setting to "Network ON". "Advanced1" - "Standby Mode" p.88





Check	Remedy
Has a critical problem developed causing the projector to momentarily stop working?	When the projector has momentarily stopped working, it cannot send e-mail messages. If the projector cannot be reset even after it has been checked, contact your dealer or the nearest address provided in the "International Warranty Conditions" section of the <i>Safety Instructions/World-Wide Warranty Terms</i> booklet.
Is power being supplied to the projector?	Check if the power supply to the location where the projector is set up has been interrupted, or if the circuit breaker for the electrical outlet that the projector is connected to has been tripped.

- The projector cannot be monitored and controlled using the EMP Monitor function.

Check	Remedy
Is the projector computer correctly connected to the network?	Check that the network cable is properly connected. If the cable is not connected, or is incorrectly connected, please connect it properly. p.18
Are the settings for connecting to a network correct ?	Check the Network advanced settings. "Connecting in Access Point Mode or Wired LAN Connection Mode" in the <i>EasyMP Setup Guide</i>
Has EMP Monitor function been correctly installed to the computer?	Uninstall EMP Monitor and then re-install it. "Installing EasyMP Software" and "Uninstalling EasyMP Software" in the <i>EasyMP Setup Guide</i>
Have all projectors that are to be monitored and controlled been registered in the projector list?	Register the projector in the projector list. " Monitoring and Control Using EMP Monitor " in the <i>EasyMP Operation Guide</i>
Has "Standby Mode" been set to "Network ON"?	If using the EMP Monitor function while the projector is in standby mode, change the "Standby Mode" menu setting to "Network ON". "Advanced1" - "Standby Mode" p.88
Is power being supplied to the projector?	Check if the power supply to the location where the projector is set up has been interrupted, or if the circuit breaker for the electrical outlet that the projector is connected to has been tripped.





- You cannot connect from another computer when images are being projected during a network connection

Check	Remedy
Has the person making the presentation left the meeting room without closing the connection?	<p>At the time of a network connection, if a different computer connects to the projector that is connecting with the computer, the connection with the current connected computer will be terminated and the next computer will be connected.</p> <p>If no projector keyword has been set in the projector or the keyword is known, it is possible to terminate the current connection and connect to the projector by establishing a new connection from the computer.</p> <p>If a projector keyword has been set in the projector and the projector keyword is unknown, terminate the connection from the projector and then reconnect. To terminate the connection from the projector, press the [ESC] button on the remote control, select the "Exit" button from the displayed menu and then press the [Enter] button on the remote control. Connect from the desired computer after terminating the connection.</p> <p>☛ "Disconnecting from a Network Connection" in the <i>EasyMP Setup Guide</i></p>



■ EMP NS Connection starts, but a projector is not found

Check	Remedy
Is a LAN card set in the card slot of the projector?	Insert a LAN card into the card slot of the projector and check that the Network Screen connection stand-by screen is displayed. If a LAN card is inserted but the Network Screen connection stand-by screen is not displayed, please remove the wireless LAN card and re-insert it into the card slot. ☛ "Inserting and Removeing Cards" p.16
Is the access lamp of the wireless LAN card set into the projector lit yellow?	If the access lamp is off, remove the wireless LAN card and re-insert it. ☛ "Inserting and Removeing Cards" p.16
If making a wireless LAN connection, is the projector in ad hoc mode connection stand by?	Is "ESSID:xxx" displayed on the Network Screen connection stand-by screen ? If this message is not displayed, activate - "ESSID ad hoc" in the Easy Connect mode advanced settings screen. ☛ "Connecting Using Easy Connect Mode" in the <i>EasyMP Setup Guide</i>
If making a wireless LAN connection, are the computer and projector set to the same ESSID?	Please set the projector to the same ESSID as the computer. Please set the computer to the same ESSID as the projector. If there are no settings for ESSID in the communication settings utility of your wireless LAN, "ESSID ad hoc" cannot be used. In this case, please use "Channel ad hoc". ☛ "Connecting Using Easy Connect Mode" in the <i>EasyMP Setup Guide</i>
Is the Network Screen Network advanced settings screen displayed on the projector?	Network connection is disabled when a Network Screen advanced settings screen is displayed. Please return to the Network Screen connection stand-by screen. ☛ "Connecting Using Easy Connect Mode" and "Connecting in Access Point Mode or Wired LAN Connection Mode" in the <i>EasyMP Setup Guide</i>
Is the computer ready for LAN card or in-built LAN functionality to be used?	Please check whether the LAN device is functioning in the Device Manager. For example, "Control panel" - "System" - "Device Manager".
If making a wireless LAN connection, is the wireless LAN setting on the computer set to ad hoc mode?	Select ad hoc mode using the communication settings utility (client manager etc.) of the wireless LAN device installed in your computer. Some wireless LAN device manufacturers, may also refer to "ad hoc" as "Wireless LAN Personal Computer Communication (Wi-Fi)", "Wi-Fi ad hoc", "802.11 ad hoc", "802.11 Mode Connection", or "Peer to Peer".
Has the LAN card you wish to use been selected in the EMP NS Connection Switch network screen?	If the computer you are using has multiple LAN environments, only those which can be selected from within EMP NS Connection can be used. Please select this LAN from the "Extension" - "Switch LAN" settings in EMP NS Connection. ☛ "Connecting Using Easy Connect Mode" and "Connecting in Access Point Mode or Wired LAN Connection Mode" in the <i>EasyMP Setup Guide</i>
If making a wireless LAN connection, are there any settings within the power saving features of your computer which disable the wireless LAN?	Please enable the wireless LAN.





Check	Remedy
Is the wireless LAN you are using Wi-Fi compliant?	Only Wi-Fi 802.11b compliant equipment can be used. You cannot use equipment conforming to any other Wi-Fi standards (802.11, 802.11a, 802.11g, etc.). Web site " http://www.epson.co.uk "
Is WEP encryption set to on?	You cannot connect in ad hoc mode unless WEP is set to OFF. Please set the WEP encryption setting to OFF. ➡ "Connecting in Access Point Mode or Wired LAN Connection Mode" in the <i>EasyMP Setup Guide</i>

■ Connection cannot be established in Access point mode or wired LAN connection mode

Check	Remedy
If in Access point mode, are the computer and projector set to the same ESSID?	Connection cannot be made unless the same ESSID is selected. Please set both the projector and computer to the same ESSID. ➡ "Connecting in Access Point Mode or Wired LAN Connection Mode" in the <i>EasyMP Setup Guide</i>
Are the computer and projector set to the same WEP key?	Connection cannot be made unless the same WEP key has been set. Set the same WEP key on the projector and computer. ➡ "Connecting in Access Point Mode or Wired LAN Connection Mode" in the <i>EasyMP Setup Guide</i>
Are the connection refusal functions of the access point, such as the MAC address and port restrictions, set correctly?	Please set the projector connection permissions on the access point.
Are the IP address of the computer and the projector, the subnet mask, and the gateway address set up correctly?	If not using DHCP, please ensure that the settings match on both the computer and the projector. ➡ "Connecting in Access Point Mode or Wired LAN Connection Mode" in the <i>EasyMP Setup Guide</i>
Are the subnets of the computer and the projector different?	Please select "Use IP connect mode" in EMP NS Connection and connect using IP connect mode. ➡ "What if the Projector You Want Does Not Appear?" in the <i>EasyMP Setup Guide</i>





■ Connection cannot be made in Ad hoc mode

Check	Remedy
Is the correct type of ad hoc mode (channel ad hoc, ad hoc or ESSID ad hoc) selected?	If you are trying to use an old type of computer to make a connection in Ad hoc mode, there are some instances where only "Channel ad hoc" can be used. Conversely, it is becoming the case that newer computers only support "ESSID ad hoc" mode. If the communication settings utility of your wireless LAN has both options, please use ESSID ad hoc, wherever possible.
If using ESSID ad hoc, is there a Melco access point operating nearby?	Ad hoc connection is not possible if there is a Melco access point set to the same ESSID, operating nearby. Please turn off the power to the Melco access point or select an ESSID different to that access point.

■ Network Screen images are not displayed or the speed is slow

Check	Remedy
Are you trying to watch a movie in the Media Player, or preview a screen saver?	Depending on the computer, the Media Player video area may not be displayed, or the screen saver preview may not be displayed correctly.
Are you connecting in Access point mode or Wired LAN connection mode?	When using Network Screen in Access point mode or Wired LAN connection mode, display speed falls compared to Easy connect mode.
Are you using WEP encryption, or connecting to multiple projectors?	Display speed falls when WEP encryption or two or more connections are being used.
Are you using DHCP when in Access point mode or Wired LAN connection mode?	If DHCP is set to "ON" in the Access point mode advanced settings screen or the Wired LAN connection mode advanced settings screen, and a connectable DHCP server is not found, it will take some time before the screen returns to the Network Screen connection stand-by screen.

■ PowerPoint slideshows will not play back in Network Screen

Check	Remedy
Are you trying to start Network Screen when PowerPoint is running?	Please close the PowerPoint application before connecting with Network Screen. If you connect when PowerPoint is already running, you will not be able to project any slideshows.



■ Network Screen cannot be used

Check	Remedy
Are you using a personal firewall?	Network Screen may be unusable when a personal firewall is set up.

■ Files do not work correctly with EMP SlideMaker2

Check	Remedy
Are you trying to use a PowerPoint (.ppt) file created in the PowerPoint 95/98 format?	Files created using PowerPoint 95/98 or files saved in PowerPoint 95/98 format cannot be edited using the EMP SlideMaker2. Use after saving once in PowerPoint 2000/2002, and then modifying it. ☛ "Files that Can be Included in Scenarios" in the <i>EasyMP Operation Guide</i>
When PowerPoint files (.ppt) cannot be pasted into a scenario, or thumbnails cannot be displayed, has the Microsoft Office JPEG converter been installed?	Install the JPEG converter. For more information about Microsoft Office JPEG converter installation, refer to the documentation for the Microsoft Office.



■ An error message is displayed.

■ Error messages from EMP NS Connection

Check	Remedy
Failed to connect to a projector.	Try to re-establish a connection. If connection is still not possible, check the LAN on the computer and the Network Screen Network advanced settings on the projector. For details concerning the Network advanced settings, ☛ "Connecting Using Easy Connect Mode" and "Connecting in Access Point Mode or Wired LAN Connection Mode" in the <i>EasyMP Setup Guide</i>
Incorrect keyword. Enter the keyword displayed on the projector.	Check the projector keyword in the Connection stand-by screen of the projector, and enter that projector keyword.
Select a connecting projector from the list.	Select the name of each projector for the connection, and click the "Connect" button. ☛ "Connecting Using Easy Connect Mode," and "Connecting in Access Point Mode or Wired LAN Connection Mode" in the <i>EasyMP Setup Guide</i>
The selected projector is in use. Continue to connect?	You are attempting to connect to a projector already connected to another computer. Click "Yes" to connect to the projector. The connection between the projector and the other computer will be terminated. Click "No" to end the connection attempt to the projector. The connection to the other computer will not be affected.
Failed to initialize EMP NS Connection.	Uninstall and then reinstall EMP NS Connection. ☛ "Uninstalling EasyMP Software" and "Installing EasyMP Software" in the <i>EasyMP Setup Guide</i>
Communication error occurred. Do you want to retry connection?	A communication error has occurred between the computer and the projector and the connection has been terminated. Click "Yes" to reconnect. If connection is still not possible, check the LAN on the computer and the Network Screen Network advanced settings on the projector. For details concerning the Network advanced settings, ☛ "Connecting Using Easy Connect Mode" and "Connecting in Access Point Mode or Wired LAN Connection Mode" in the <i>EasyMP Setup Guide</i> Click "No" to remain disconnected and close this message screen.
One of the projectors cannot be connected with the keyword entered.	The wrong keyword was entered when trying to connect to a projector with a projector keyword. Check the projector Connection stand-by screen for the correct projector keyword. Terminate the connection, reconnect and enter the projector keyword on the displayed keyword input screen. ☛ "Connecting Using Easy Connect Mode" and "Connecting in Access Point Mode or Wireless LAN Connection Mode" in the <i>EasyMP Setup Guide</i>





Check	Remedy
<p>Failed to obtain network adaptor information. Check network settings and restart.</p>	<p>Check the following:</p> <ul style="list-style-type: none"> • Is a network adapter installed in the computer ? • Is the driver for the network adapter installed in the computer ? <p>After checking, restart the computer and try to connect. If connection is still not possible, check the LAN on the computer and the Network Screen Network advanced settings on the projector. For details concerning the Network advanced settings, ☛ "Connecting Using Easy Connect Mode" and "Connecting in Access Point Mode or Wireless LAN Connection Mode" in the <i>EasyMP Setup Guide</i></p>
<p>Some projectors do not support SXGA. Reduce resolution and retry.</p>	<p>One of the projectors you are connecting to is an EMP-735. Change the screen resolution of the computer to SXGA (1280 × 1024) or lower.</p>
<p>There is a projector not responding.</p>	<p>One or more projectors failed to connect when an attempt was made to connect simultaneously to multiple projectors. The successfully connected projectors can be used. To connect to the projectors that failed to connect, terminate the connection and try again. If connection is still not possible, check the LAN on the computer, and the Network Screen Network advanced settings on the projector. For details concerning the Network advanced settings, ☛ "Connecting Using Easy Connect Mode" and "Connecting in Access Point Mode or Wired LAN Connection Mode" in the <i>EasyMP Setup Guide</i></p>
<p>Enter the keyword displayed on the projector.</p>	<p>Check the projector keyword displayed on the connection stand-by screen of the projector and enter that projector keyword.</p>
<p>Cannot find a projector of the specified IP address.</p>	<p>Ensure that the "Access point mode" or "Wired LAN connection mode" setting is being used in the Network Screen Network advanced settings of the desired projector. Change to Access point mode or Wired LAN connection mode, if set to Easy connect mode. Next, check the "IP address" in the Access point mode advanced settings screen or Wired LAN connection mode advanced settings screen and specify this "IP address" when connecting in IP connection mode. ☛ "What if the projector you want does not appear?" in the <i>EasyMP Setup Guide</i> If connection is still not possible, check the LAN on the computer and the Network Screen Network advanced settings on the projector. For details concerning the Network advanced settings, ☛ "Connecting in Access Point Mode or Wired LAN Connection Mode" in the <i>EasyMP Setup Guide</i></p>





Check	Remedy
Image transfer slows if PC resolution is higher than XGA (1024 × 768 pxl.) Do you want to continue?	The display of the computer being connected to the projector is set to resolution higher than XGA (1024 × 768). Clicking "Yes" connects the projector. However, the display speed of the projection screen will be slow. Clicking "No" aborts the projector connection. To avoid slow display speeds on the projection screen, change the computer display settings to: XGA (1024 × 768) or lower.
Image transfer slows if screen color is more than 24 bits. NS Connection converts it to 16 bits. Do you want to continue?	The display colours of the computer being connected to the projector is set to 24 bits or higher. Clicking "Yes" connects the projector. However, the display will be in 16 bit colour..

■ Error messages from EMP SlideMaker2

Check	Remedy
** already registered. (** is the scenario file name.)	It is not possible to add a scenario file name if it already exists in the "Autorun Scenario List". ☛ "Sending a Scenario" in the <i>EasyMP Operation Guide</i>
Not enough disk space.	The drive to which a scenario is being sent has insufficient free space and the scenario cannot be sent. Delete unneeded files on the destination drive to free sufficient disk space to save the scenario on the drive.
** contains an invalid path. (** is the path name containing the scenario file.)	The path of the file to be opened could not be found. This could be for the following reasons. <ul style="list-style-type: none"> •After the last time the scenario file was saved by EMP SlideMaker2, the file was moved to another folder. •After the last time the scenario file was saved by EMP SlideMaker2, the folder name was changed. •The desired scenario file has been deleted. Open the desired scenario file by selecting "File"->"Open", or search for the file using the Windows "Search for Files or Folders" function.
Disk full while accessing **. (** is the path name including the scenario file)	The drive containing the scenario folder has insufficient free space, and could not save the scenario file. Delete unneeded files on the drive containing the scenario folder to free sufficient disk space allowing the scenario file to be saved.
Cannot open the proposed file.	The PowerPoint file to be added to the scenario is damaged or corrupted and cannot be used. Use a different PowerPoint file.
Change name or directory	A file or scenario folder of the same name already exists. Change the scenario name or the scenario folder name and try saving again.





■ Error messages from EMP Monitor

Check	Remedy
The password is incorrect.	An incorrect password was entered. Enter the correct password. If you have forgotten the password, check the "Password for WEB control" in the Network Screen Network advanced settings on the projector.
Cannot connect to the projector of the IP address entered.	<p>Ensure that the "Access point mode" or "Wired LAN connection mode" setting is being used in the Network Screen Network advanced settings of the projector. Change to Access point mode or Wired LAN connection mode, if set to Easy connect mode.</p> <p>Next, check the "IP address" in the Access point mode advanced settings screen, or Wired LAN connection mode advanced settings screen and specify this "IP address" when connecting in IP connect mode. ➤ "What if the projector you want does not appear" in the <i>EasyMP Setup Guide</i></p> <p>If connection is still not possible, check the LAN on the computer and the Network Screen Network advanced settings on the projector.</p> <p>For details concerning the Network advanced settings ➤ "Connecting in Access Point Mode or Wired LAN Connection Mode" in the <i>EasyMP Setup Guide</i></p>



Appendices

This chapter provides information on maintenance procedures to ensure the best level of performance for the projector for a long time.

Maintenance	119	List of ESC/VP21 Commands.....	133
• Cleaning	119	• Command List	133
• Cleaning the Projector Case	119	• Communication Protocol	133
• Cleaning the Lens.....	119	• Cable Layouts	134
• Cleaning the Air Filters and Air Intake Vent	119	• Serial connection	134
• Replacing Consumables.....	120	• USB connection	134
• Lamp Replacement Period	120	• USB Connection Setup.....	135
• Replacing the Lamp	121	List of Supported Monitor Displays	136
• Resetting the Lamp Operating Time	124	• Computer/RGB Video	136
• Replacing the Air Filters	125	• Component Video	136
Saving a User's Logo	126	• Composite Video/S-Video	136
Optional Accessories	129	Specifications	137
Glossary	130	Appearance.....	139



This section describes maintenance tasks such as cleaning the projector and replacing consumable parts.

Cleaning

You should clean the projector if it becomes dirty or if the quality of projected images starts to deteriorate.



CAUTION

Be sure to read the separate Safety Instructions/World-Wide Warranty Terms before cleaning.

Cleaning the Projector Case

Clean the projector case by wiping it gently with a soft cloth. If the projector is particularly dirty, moisten the cloth with water containing a small amount of neutral detergent, and then firmly wring the cloth dry before using it to wipe the projector case. Then wipe the case again with a soft, dry cloth.



CAUTION

Do not use volatile substances such as wax, alcohol or thinner to clean the projector case. These can cause the case to warp and make the coating finish peel off.

Cleaning the Lens

Use a commercially-available air blower, or use lens cleaning paper to clean the lens.



CAUTION

Do not rub the lens with harsh materials or subject the lens to shocks, as it can easily become damaged.

Cleaning the Air Filters and Air Intake Vent

If the air filters become clogged with dust, or if the message "The projector is overheated. Clean or replace the air filter and lower the room temperature." appears on the screen, clean the air filters and the air intake vent.

If the air filters become clogged with dust, it can cause overheating and damage the projector.

- Air intake vents in rear, side and base of projector

Turn the projector upside-down and use a vacuum cleaner to clean the air intake vent.

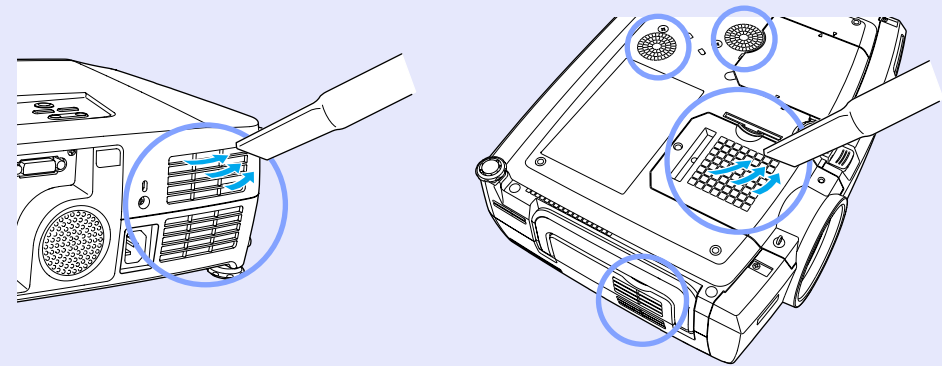

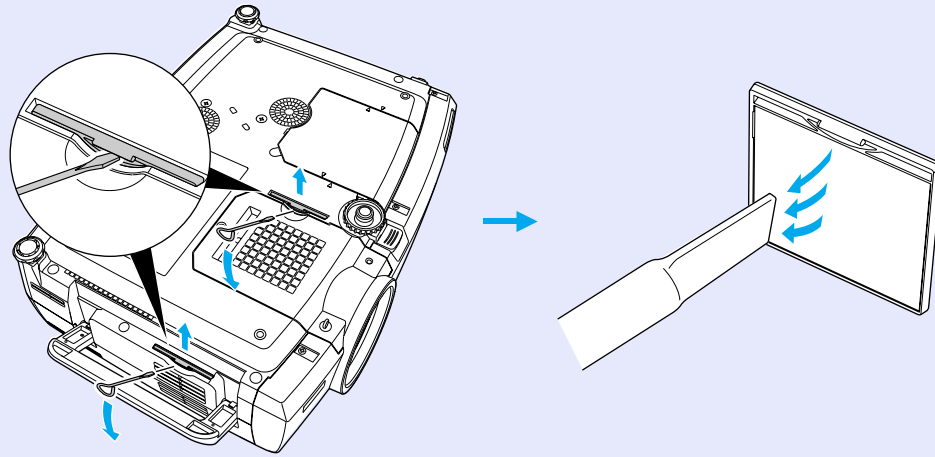

- Air filters at side and base of projector
Pull the air filters out from the projector and then use a vacuum cleaner to clean them.

**TIP**

- *If the air filters are broken or if the warning message reappears after they have been cleaned, they should be replaced. Replace them with new air filters. See "Appendices: Optional Accessories" p.129*
- *Spare lamps are provided with spare air filters. The air filters should also be replaced when the lamp is replaced.*

Replacing Consumables

This section describes how to replace the lamp and the air filters.

Lamp Replacement Period

It is time to replace the lamp when:

- The message "Lamp Replace." appears on the screen when projection starts

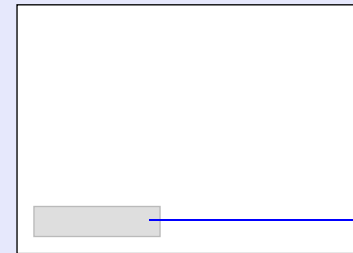

A message will be displayed.

- The  indicator is flashing orange

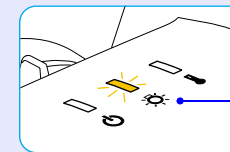

Flashes orange

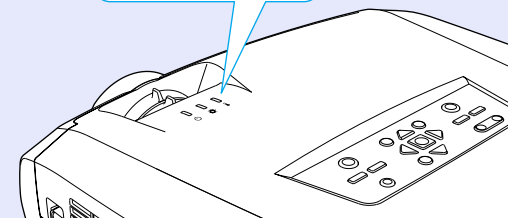

- The projected images get darker or start to deteriorate in quality.

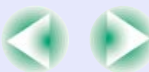



TIP

- *The replacement warning message is set to appear after the following periods of lamp use, in order to maintain the initial brightness and quality of the projected images.*
 - *When used continuously at high luminosity: about 1900 hours.*
 - *When used continuously at low luminosity: about 2900 hours.*
- *"Brightness Control" p.89*
If you continue to use the lamp after this period, the possibility of the lamp breaking becomes greater. When the lamp replacement message appears, replace the lamp with a new one as soon as possible, even if it is still working.
- *Depending on the characteristics and usage conditions of individual lamps, some lamps may darken or stop operating before the message is displayed. You should always have a spare lamp ready in case it is needed.*
- *Contact your dealer for a spare lamp.*

■ Replacing the Lamp



CAUTION

- *If you are replacing the lamp because it has stopped working, it is possible that the lamp is broken.*
If replacing the lamp of a projector which has been installed to the ceiling, you should always assume that the lamp is broken and be extremely careful when removing the lamp cover.
- *Wait until the lamp has cooled down sufficiently before removing the lamp cover. It takes a further one hour after the [cool-down](#) period has finished for the lamp to be cool enough.*

PROCEDURE

1

Turn the projector's power off, wait for the cool-down period to end, and then disconnect the power cable.

The cool-down period lasts for about 30 seconds.

2

Wait until the lamp has cooled down, and then remove the lamp cover from the base of the projector.

It takes a further one hour after the cool-down period has finished for the lamp to be cool enough.

Insert the screwdriver that is supplied with the spare lamp or some other flat-tipped screwdriver into the hollow between the air filter and the air filter cover. Slide the lamp cover until the [▷] mark on the lamp cover is aligned with the [◁] mark on the projector, and then lift up the lamp cover to remove it.

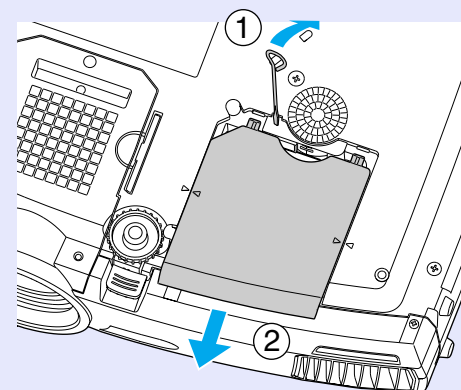



3 Loosen the two lamp fixing screws.

Use the screwdriver that is supplied with the spare lamp or some other flat-tipped screwdriver to loosen the two lamp fixing screws that are securing the lamp to the projector.

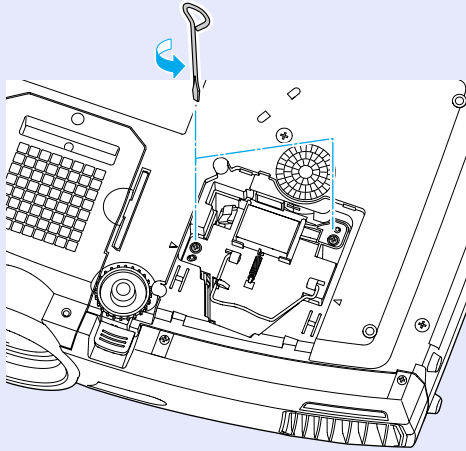

4 Take out the old lamp.

Fold out the handle as shown in the illustration below and pull the lamp out of the projector.

If the lamp is broken, replace it with a new lamp, or contact your local dealer for further advice. If replacing the lamp yourself, be careful to avoid pieces of broken glass.

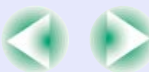
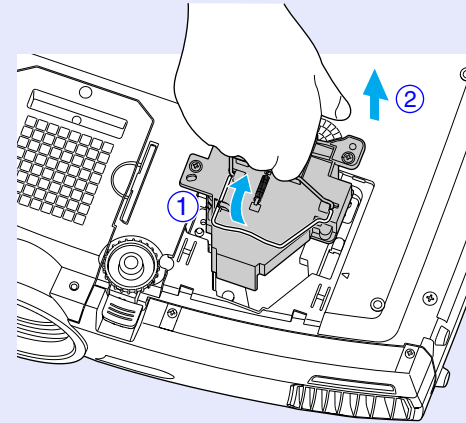

5 Install the new lamp.

Hold the lamp so that it faces the correct way to fit into the projector, and then insert the lamp until it clicks into place and tighten the two lamp fixing screws.

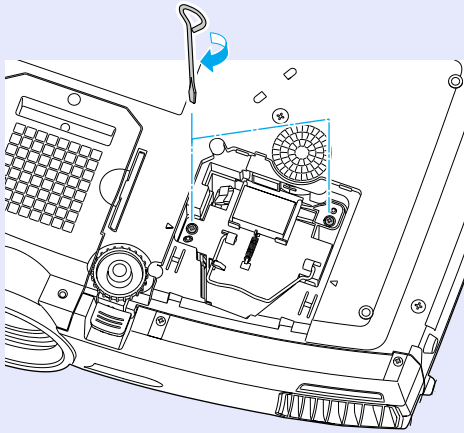

6 Install the lamp cover.

Slide the cover in until it clicks into place.

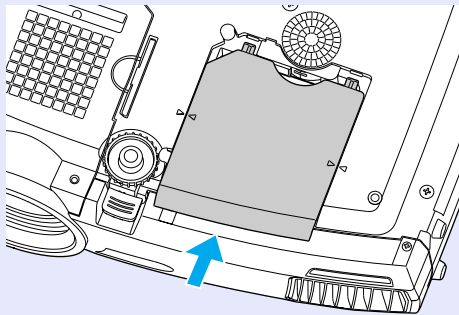

TIP

- *Install the lamp securely. If the lamp cover is removed, the lamp turns on automatically as a safety precaution. Moreover, the lamp will not turn on if the lamp or the lamp cover is not installed correctly.*
- *Spare lamps are provided with spare air filters. The air filters should also be replaced when the lamp is replaced. [p.125](#)*
- *Dispose of used lamps properly in accordance with your local regulations.*





Resetting the Lamp Operating Time

The projector has a built-in counter which keeps track of the lamp operating time, so that when the cumulative operating time reaches a certain point, it causes the replacement warning message to be displayed. Therefore, the counter needs to be reset using the configuration menu after the lamp has been replaced with a new one.



TIP

Do not reset the lamp operating time except after the lamp has been replaced. If the lamp operating time is reset at any other time, the lamp replacement period will not be indicated correctly.

PROCEDURE

- 1 Connect the power cable, turn on the projector's power, and then press the [Menu] button on the remote control.

The configuration menu will be displayed.

Remote control

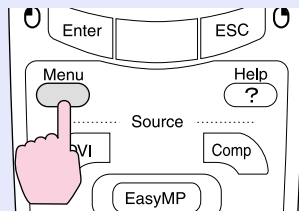

- 2 Select "Reset Lamp Timer" from the "About" menu and then press the [Enter] button on the remote control or the [Auto/Enter] button on the projector's control panel.

Lamp	: 1900H
Reset Lamp Timer	↩ → Execute
Source	: Computer
Input Signal	: Analog-RGB
Frequency	: H ---.-kHz
	: V ---.-Hz
SYNC Polarity	: H -----
	: V -----
SYNC Mode	: -----
Resolution	: 0x 0
Refresh Rate	: 0.0 Hz

- 3 Select "Yes" and then press the [Enter] button on the remote control or the [Auto/Enter] button on the projector's control panel.

The lamp operating time will then be reset.





■ Replacing the Air Filters

The air filters can be replaced even if the projector is installed on a ceiling.

PROCEDURE

- 1** Turn the projector's power off, wait for the **cool-down** period to end, and then disconnect the power cable.

The cool-down period lasts for about 30 seconds.

- 2** Pull out the air filters. Insert a flat-tipped screwdriver into the hollow as shown in the illustration below, and then pull it straight upwards.

The projector has two air filters.
Fold out the handle before removing the air filter at the side.

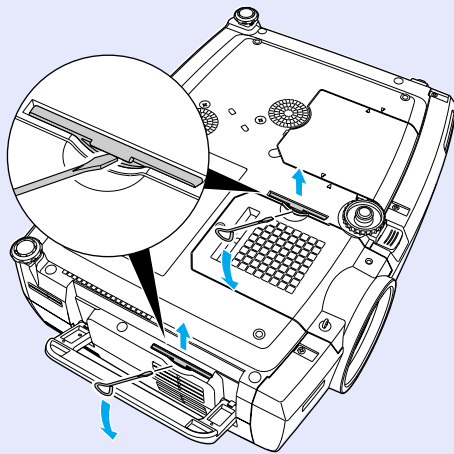

- 3** Insert the two new air filters, and push them in until they click into place.

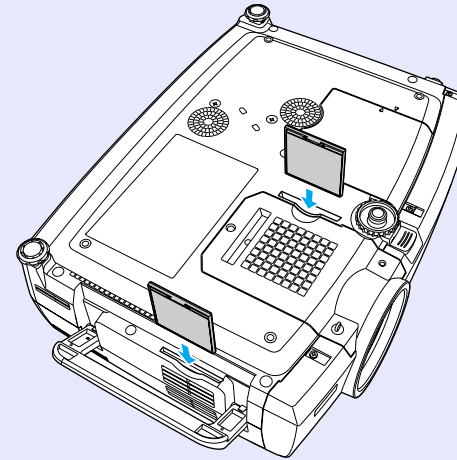

TIP

Dispose of used air filters properly in accordance with your local regulations.



Saving a User's Logo

You can record the image that is currently being projected as a user's logo.



TIP

When a user's logo is recorded, the previous user's logo will be erased.

PROCEDURE

- 1 Project the image that you would like to use as a user's logo, and then press the [Menu] button on either the remote control or the projector's control panel.
- 2 Select the "User's Logo" menu, and then press the [Enter] button on the remote control or the [Auto/Enter] button on the projector's control panel.

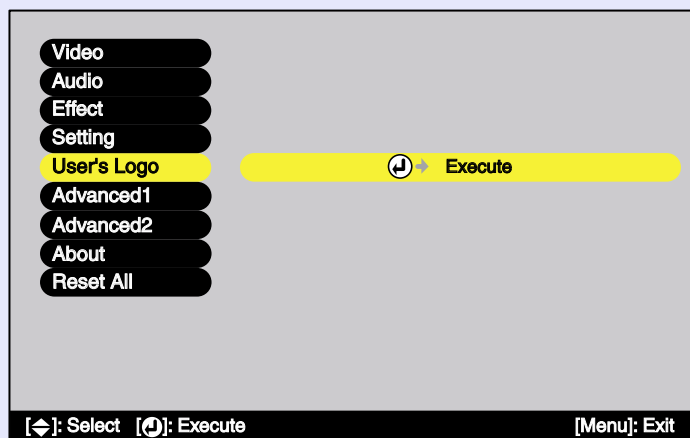

TIP

If keystone correction or the E-Zoom function have been used, they will be cancelled when the "User's Logo" menu is selected.

3

- 3 Select "Yes" in the sub-menu, and then press the [Enter] button on the remote control or the [Auto/Enter] button on the projector's control panel.

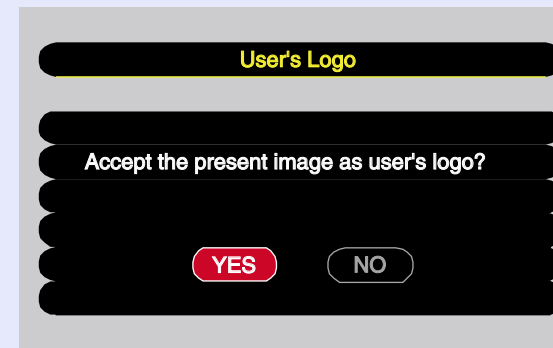

TIP

When you press the [Enter] button on the remote control or the [Auto/Enter] button on the projector's control panel, the images will be projected at their original image signal resolution, so that when you are projecting images which have a resolution that is different from the number of pixels on the projector's panel, and when you are projecting video images, the display size will change.





- 4** The image to be recorded and a selection marquee box will be displayed, so move the marquee box to select the part of the image to use.

Tilt the [○] button on the remote control or press the [△], [▽], [◀] and [▶] buttons on the projector's control panel to select the part of the image to use as the user's logo, and then press the [Enter] button on the remote control or the [Auto/Enter] button on the projector's control panel.

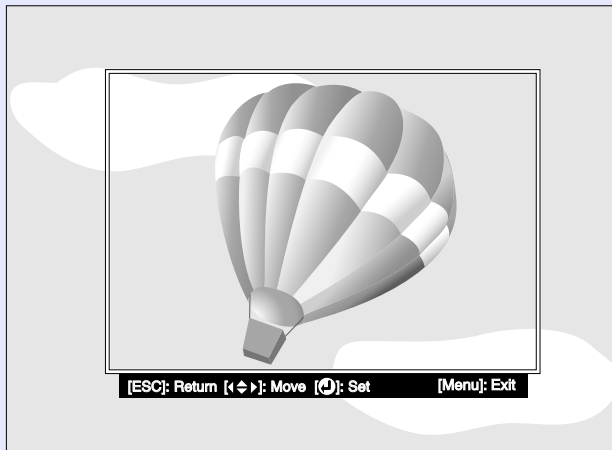
**TIP**

User's logos can be saved at up to 480 × 360 dots in size.

- 5** Select "Yes" at the confirmation screen, and then press the [Enter] button on the remote control or the [Auto/Enter] button on the projector's control panel.

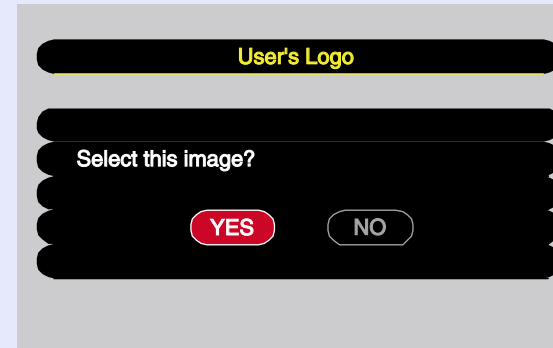

- 6** Select the zoom rate in the Zoom rate setting screen, and then press the [Enter] button on the remote control or the [Auto/Enter] button on the projector's control panel.

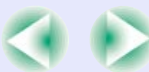
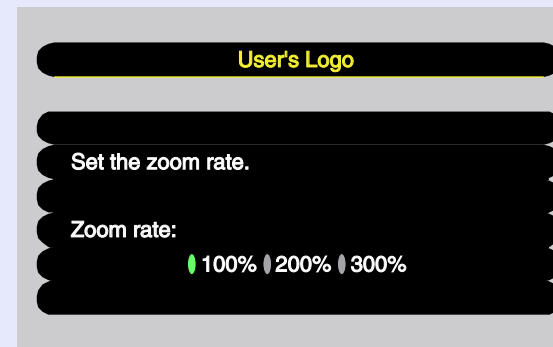



Saving a User's Logo

- 7 Select "Yes" at the confirmation screen, and then press the [Enter] button on the remote control or the [Auto/Enter] button on the projector's control panel.

The image will then be saved. Once the image has been saved, the message "Completed." will be displayed.

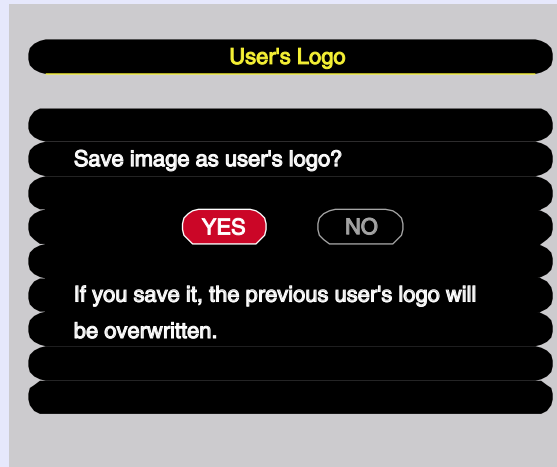

TIP

- *Saving the user's logo may take a few moments (about 15 seconds). Do not use the projector or any other sources which are connected to the projector while the user's logo is being saved. If this is not observed, it may result in errors in projector operation.*
- *Once a user's logo has been saved, the logo setting cannot be returned to the factory default.*





Optional Accessories

The following optional accessories are available for purchase if required. This list of optional accessories is current as of June 2003. Details of accessories are subject to change without notice.

Soft carry case ELPKS28 Hard travel case ELPKS29 Use this case if you need to carry the projector by hand.
Spare lamp ELPLP22 (Set with spare lamp and two spare air filters) Use as a replacement for spent lamps.
Filter kit (3 sets of 2 air filters (total 6)) ELPAF01 Use as a replacement for spent air filters.
40" "Billboard Vision" screen *1 ELPHS01 60" "Billboard Vision" screen ELPHS03 A translucent-type screen. (Aspect ratio ▶4:3)
60" screen ELPSC07 80" screen ELPSC08 100" screen ELPSC10 A portable roll-type screens. (Aspect ratio 4:3)
50" portable screen ELPSC06 A compact screen which can be carried easily. (Aspect ratio 4:3)
VGA-HD15 PC cable ELPKC02 (1.8 m (6 ft.) - for mini D-Sub 15-pin/mini D-Sub 15-pin) This is the same computer cable as the projector's accessory computer cable.
VGA-HD15 PC cable ELPKC09 (3 m (9.8 ft.) - for mini D-Sub 15-pin/mini D-Sub 15-pin) VGA-HD15 PC cable ELPKC10 (20 m (65.6 ft.) - for mini D-Sub 15-pin/mini D-Sub 15-pin) Use these extension cables if the accessory computer cable is too short.
VGA-HD15/BNC PC cable ELPKC11 (1.8 m (6 ft.) - for mini D-Sub 15-pin/5BNC) Use in order to connect the projector to a computer with a 5BNC port.
Digital video cable DVI-D/DVI-D ELPKC20 (3 m (9.8 ft.) - for DVI-D male/male) This is a DVI ▶ cable for connecting the projector to a computer with a digital RGB output interface.

Digital video cable DVI-D/DFP ELPKC21 (3 m (9.8 ft.) - for DVI-D/DFP 20-pin) This is a DFP ▶ cable for connecting the projector to a computer with a digital RGB output interface.
Remote control cable set ELPKC28 (10 m - for 3.5 mm dia. mini plug (male-male)) (10 m - for 3.5 mm dia. mini jack (male-female)) Use in order to operate the projector accurately by remote control from a distance.
Long throw zoom lens *2 ELP LL05 (Projection distance ratio: Approx. 2.33–3.15) Medium throw zoom lens *2 ELPLM03 (Projection distance ratio: Approx. 1.75–2.36) Projection distance ratio = Projection distance/Width of projection area The values should be used as a guide for setting up. The value will vary depending on setup conditions and the zoom setting.
Ceiling plate *3 ELPFC03 Pipe 370 (370 mm (14.57 in.)/silver) *3 ELPFP04 Pipe 570 (570 mm (22.44 in.)/silver) *3 ELPFP05 Pipe 770 (770 mm (30.31 in.)/silver) *3 ELPFP06 Use when installing the projector on a high ceiling or a ceiling with veneer panels.
Ceiling mount *3 ELPMB13 Use when installing the projector on a ceiling.
Image presentation camera ELPDC02 ELPDC03 ELPDC04 Use to project books, etc.

*1 The 40 "Billboard Vision" screen cannot be used in combination with the Long throw zoom lens.

*2 Cannot be installed by the customer. Please contact your dealer for assistance.

*3 A special method of installation is required in order to suspend the projector from the ceiling. Please contact your supplier if you would like to use this installation method.



Following is an explanation of some of the terms used in this guide which may be unfamiliar or which were not explained in the text of this guide itself. Further information can be obtained by referring to other commercially-available publications.

3-2 pull-down function	This function directly converts image sources that have been recorded in the same 24-frame format used for movies into 60-frame progressive signals. This allows data such as DVD software that has been recorded in 24-frame format to be played back on large screens with more natural and accurate reproduction, without any loss of image quality from the original movie.
5BNC	A port used to input analogue video signals.
Aspect ratio	The ratio between an image's length and its height. HDTV images have an aspect ratio of 16:9 and appear elongated. The aspect ratio for standard images is 4:3.
Channel	Communication speeds will drop if there are too many devices performing wireless communication using the same frequency. In this case, it is possible to avoid interference from other wireless LANs by setting a wireless channel for each wireless LAN network.
Colour temperature	The temperature of an object which is emitting light. If the colour temperature is high, the colours tend to take on a bluish tinge. If the colour temperature is lower, the colours tend to take on a reddish tinge.
Component video	Video signals which have the video brightness signals and colour signals separated, in order to provide better image quality. In high-definition TV (HDTV), it refers to images which consist of three independent signals: Y (luminance signal), and Pb and Pr (colour difference signals).
Composite video	Video signals which have the video brightness signals and colour signals mixed together. The type of signals commonly used by household video equipment (NTSC, PAL and SECAM formats). The signals consist of the carrier signal Y (luminance signal) and the chroma (colour) signal which are contained in the colour bar signal.
Contrast	The relative brightness of the light and dark areas of an image can be increased or decreased in order to make text and graphics stand out more clearly, or to make them appear softer. Adjusting this particular property of an image is called "contrast adjustment".
Cool-down	Use this procedure to cool a projector lamp that is hot from use. Cool-down happens automatically when the [Power] button is pressed on the projector or on the remote control to turn the projector off. Do not unplug the projector power cable whilst it is cooling down. If the lamp does not cool down properly, heat from the lamp is trapped inside the projector, potentially shortening the life of the lamp and causing projector failure.
DFP	Abbreviation for Digital Flat Panel. Refers to a standard method for digital transmission of video signals.
DHCP	Abbreviation of Dynamic Host Configuration Protocol. This protocol automatically assigns an IP address to a computer connected to a network.
Dolby Digital	A sound format developed by Dolby Laboratories. Normal stereo is a 2-channel format which uses two speakers. Dolby Digital is a 6-channel (5.1-channel) system which adds to this a centre speaker two rear speakers and a sub-woofer.
DPOF	Abbreviation of Digital Print Order Format, which is a format used to record information concerning the printing of photographs taken with a digital camera (which images to print, how many copies, etc.) to recordable media, such as a memory card.
DVI	Abbreviation for Digital Visual Interface. Refers to a standard method for digital transmission of video signals. DVI is a standard which has also been applied to digital household electronic equipment other than computers. It allows images to be transmitted at higher resolutions than for DFP, and also includes a digital signal encoding function.





EMP Link21L	A utility software program that allows the projector to be connected to a computer so that the computer can be used to control the projector. For details on acquiring the software and for instructions on using the software and compatible projector models, please visit the web site http://www.epson.co.uk/support/download/projector.htm .
ESSID	ESS is an abbreviation of Extended Service Set. The ESSID is an identification number for connecting with a counterpart on a wireless LAN. Wireless communication is possible between devices with corresponding ESSID numbers.
Film judgment function	A function for judging whether an image source is a 24 Hz progressive film source or not.
Gateway	A server (router) for communicating across a network divided according to subnet masks.
HDTV	An abbreviation for High-Definition Television. It refers to high-definition systems which satisfy the following conditions. Vertical resolution of 750p or 1125i or greater (p = progressive scanning , i = interlaced scanning) Screen aspect ratio of 16:9 Dolby Digital audio reception and playback (or output)
Interlaced	A method of image scanning whereby the image data is divided into fine horizontal lines which are displayed in sequence starting from left to right and then from the top to the bottom of the screen. The even-numbered lines and odd-numbered lines are displayed alternately.
IP address	A series of numbers that identifies a device that is connected to a network.
MAC address	MAC is an abbreviation of Media Access Control. The MAC address is an ID number unique to each network card. A unique number is assigned to each network card. Data is transmitted between cards (devices) based on this identification.
Progressive	A method of image scanning whereby the image data from a single image is scanned sequentially from top to bottom to create a single image.
Refresh rate	The light-emitting element of a display maintains the same luminosity and colour for an extremely short time. Because of this, the image must be scanned many times per second in order to refresh the light-emitting element. The number of refresh operations per second is called the "refresh rate", and is expressed in hertz (Hz).
Resized display	This function is used to project computer images that have a resolution more than or less than the projector's panel resolution to be projected so that they fill the whole of the projection area.
SDTV	An abbreviation for Standard Definition Television. It refers to standard television systems which do not satisfy the conditions for High-Definition Television.
Security lock	A device consisting of a projector case with a hole in it that a commercially-available theft-prevention cable can be passed through in order to secure the device to a table or pillar. This projector is compatible with the Microsaver Security System manufactured by Kensington.
SNMP	An abbreviation for Simple Network Management Protocol, which is the protocol for monitoring and controlling devices such as routers and computers connected to a TCP/IP network.
Squeeze mode	To reduce the width of a 16:9 wide-screen video image, record the video image as 4:3 in the video software. Setting the aspect ratio to 16:9 on the projector will restore the video image to 16:9 wide-screen format.
sRGB	An international standard for colour intervals that was formulated so that colours which are reproduced by video equipment can be handled easily by computer operating systems (OS) and the Internet.
Subnet mask	This is a number which defines, from the IP address, the number of bits used in network addresses of assigned networks (subnets).
SVGA	A type of video signal with a resolution of 800 (horizontal) × 600 (vertical) dots which is used by IBM PC/AT-compatible computers.





S-Video	A video signal which has the luminance component and colour component separated in order to provide better image quality. It refers to images which consist of two independent signals: Y (luminance signal), and C (colour signal).
SXGA	A type of video signal with a resolution of 1280 (horizontal) × 1024 (vertical) dots which is used by IBM PC/AT-compatible computers.
Sync. (Synchronization)	The signals output from computers have a specific frequency. If the projector frequency does not match this frequency, the resulting images will not be of a good quality. The process of matching the phases of these signals (the relative position of the crests and troughs in the signal) is called "synchronisation". If the signals are not synchronized, problems such as flickering, blurriness and horizontal interference can occur.
Tracking	The signals output from computers have a specific frequency. If the projector frequency does not match this frequency, the resulting images will not be of a good quality. The process of matching the frequency of these signals (the number of crests in the signal) is called "tracking". If tracking is not carried out correctly, wide vertical stripes will appear in the projected images.
Trap IP address	This is the IP address of the messaged computer used for error notification in SNMP.
USB	An abbreviation for Universal Serial Bus. USB is an interface for connecting personal computers to peripheral devices which only support relatively low data transmission speeds.
UXGA	A type of video signal with a resolution of 1600 (horizontal) × 1200 (vertical) dots which is used by IBM PC/AT-compatible computers.
VGA	A type of video signal with a resolution of 640 (horizontal) × 480 (vertical) dots which is used by IBM PC/AT-compatible computers.
WEP	This is an abbreviation of Wired Equivalent Privacy. This is a security method which encrypts data during transmission. Data communication cannot be performed unless the sending and receiving machines are registered with the same encryption key by the WEP.
XGA	A type of video signal with a resolution of 1024 (horizontal) × 768 (vertical) dots which is used by IBM PC/AT-compatible computers.
YCbCr	The carrier signal which is contained in the colour bar signal used in modern TV transmissions. The name comes from the Y (luminance) signal and the CbCr (chroma (colour)) signals.
YPbPr	The carrier signal which is contained in the colour bar signal used in high-definition TV (HDTV) transmissions. The name comes from the Y (luminance) signal and the PbPr (colour difference) signals.





List of ESC/VP21 Commands

Command List

When a power ON command is sent to the projector, the power for the projector turns on. When the projector is in a command ready state, it returns the "3Ah" (:) code.

Furthermore, when command processing is complete, the projector also returns a ":" code.

The ":" code status can be used to determine whether the projector is ready or busy. If command processing terminates with an error, an error message is output and then the ":" code is sent.

	Item	Command
Power ON/OFF	ON	PWR ON
	OFF	PWR OFF
Signal selection	Computer	SOURCE 10
	DVI▶▶	SOURCE 30
	Video	SOURCE 41
	S-Video	SOURCE 42
	BNC	SOURCE B0
A/V Mute ON/OFF	ON	MUTE ON
	OFF	MUTE OFF
A/V Mute Selection	Black	MSEL 00
	Blue	MSEL 01
	User's Logo	MSEL 02

Communication Protocol

- Standard baud rate : 9600 bps
- Data length : 8 bits
- Parity : None
- Stop bit : 1 bit
- Flow control : None
- Connector shape : D-Sub 9-pin (male)
- Projector input port : Control (RS-232C)



Cable Layouts

Serial connection

- Connector shape : D-Sub 9-pin (male)
- Projector input connector : Control (RS-232C)

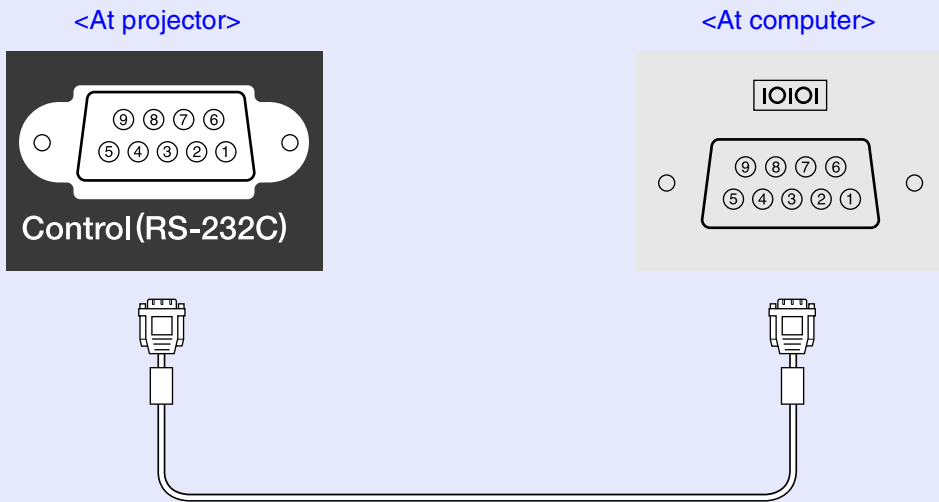

<At projector>		(PC serial cable)		<At computer>		Signal	Function
GND	5	—————	5	GND		GND	Signal wire earth
RD	2	←————	3	TD		TD	Transmit data
TD	3	————→	2	RD		RD	Receive data
DTR	4	————→	6	DSR		DSR	Data set ready
DSR	6	←————	4	DTR		DTR	Data terminal ready

USB connection

- Connector shape : USB(type B)



* The [USB TypeA] port does not have a USB hub function.



USB Connection Setup

In order to control the projector using ESC/VP21 commands via a USB connection, the following preparations must be carried out.

PROCEDURE

- 1** Download the [EMP Link21L](#) utility software from the EPSON website to the computer being used.

For details on acquiring the software, please visit the Web site <http://www.epson.co.uk/support/download/projector.htm>.

- 2** The USB driver (USB-COM Driver) will be downloaded together with the utility software, so install this USB driver on the computer that is to be used.

Read the instructions displayed on the download screen.

- 3** Change the "COM Port" setting in the "Advanced2" menu to "USB".

- 4** Turn the projector off.

- 5** After the [cool-down](#) period has finished, turn the projector's power back on.

Once the projector's power has turned back on, communication via a USB connection will then be possible.



CAUTION

If the power cable is disconnected before cool-down has finished, the communication port will not be changed.



List of Supported Monitor Displays

■ Computer/RGB Video

Signal	Refresh rate ^{▶▶} (Hz)	Resolution (dots)	Resolutions for resized display ^{▶▶} (dots)
VGA/EGA		640×350	1024×560
VGA ^{▶▶}	60/72/75/85/100/ 120, iMac ^{*1}	640×480	1024×768
SVGA ^{▶▶}	56/60/72/75/85/ 100/120, iMac ^{*1}	800×600	1024×768
XGA ^{▶▶}	60/70/75/85/100/ 120, iMac ^{*1}	1024×768	1024×768
SXGA ^{▶▶}	70/75/85/100	1152×864 ^{*2}	1024×768
SXGA	60/75/85	1280×960 ^{*2}	1024×768
		1280×1024 ^{*2}	960×768
SXGA+	60/75/85	1400×1050 ^{*2}	1024×768
UXGA ^{▶▶}	60/65/70/75/80/85	1600×1200 ^{*2}	1024×768
MAC13"		640×480	1024×768
MAC16"		832×624	1024×768
MAC19"		1024×768	1024×768
MAC21"		1152×870 ^{*2}	1016×768
SDTV ^{▶▶} (525i, 525p, 625i, 625p)			1024×768 (4:3 aspect ratio ^{▶▶})
			1024×576 (16:9 aspect ratio)
HDTV ^{▶▶} (750p)			1024×576
HDTV (1125i, 1125p)			1024×576

*1 Connection is not possible if the equipment does not have a VGA output port.

*2 The resolution for real display is the virtual (window) display resolution.

It may be possible to project signals which are not listed in the above table. However, not all functions may be supportable with such signals.

■ Component Video

Signal	Display mode (dots)	
	4:3 aspect ratio ^{▶▶} display	16:9 aspect ratio display
SDTV ^{▶▶} (525i, 525p, 625i, 625p)	1024×768	1024×576
HDTV ^{▶▶} (750p) 16:9	–	1024×576
HDTV(1125i) 16:9	–	1024×576

■ Composite Video/S-Video

Signal	Display mode (dots)	
	4:3 aspect ratio ^{▶▶} display	16:9 aspect ratio display
TV(NTSC)	1024×768	1024×576
TV (PAL,SECAM)	1024×768	1024×576



Specifications

Product name	Multimedia Projector EMP-7850
Dimensions	419 (W) × 117 (H) × 325 (D) mm (16.5 (W) × 4.6 (H) × 12.8 (D) in.) (not including feet)
Panel size	1.0 inches
Display method	Polysilicon TFT
Resolution	XGA ▶ 786,432 pixels (1024 (W) × 768 (H) dots) × 3
Focus adjustment* ¹	Manual
Zoom adjustment* ¹	Manual (approx. 1:1.35)
Lamp (light source)	UHE lamp, Rated 250 W, Model No.: ELPLP22
Max. audio output	5 W monaural
Speaker	1
Power supply	100–240 VAC 3.6–1.6 A 50/60 Hz
Operating temperature	+5°– +35°C (41°–95°F) (No condensation)
Storage temperature	-10°– +60°C (14°–140°F) (No condensation)
Weight	Approx. 5.8 kg (12.1 lbs)

Connectors	DVI:	1	DVI-D
	Computer:	1	Mini D-Sub 15-pin (female) Blue
	Audio input:	1	Stereo mini jack
	USB* ² :	2	USB connector (type A,B)
	BNC:	1	5BNC (female)
	Audio input:	1	RCA pin jack × 2 (L, R)
	S-Video:	1	Mini DIN 4-pin
	Audio input:	1	RCA pin jack × 2 (L, R)
	Video:	1	RCA pin jack
	Audio input:	1	RCA pin jack × 2 (L, R)
	Control (RS-232C):	1	D-Sub 9-pin (male)
Remote:	1	Stereo mini jack	
Monitor Out:	1	Mini D-sub 15-pin (female) Black	
Audio Out:	1	Stereo mini jack	
Card Slot	PCMCIA:	1	TypeII slot

*1 These values are for when the standard lens is fitted. Refer to the documentation supplied with optional lenses for details on those lenses.

*2 The USB connector is not guaranteed to operate correctly with all USB-compatible devices.



Safety

USA

UL1950 3rd Edition

Canada

CSA C22.2 No.950-95 (cUL)

European Community

The Low Voltage Directive (73/23/EEC)

IEC60950 2nd Edition, +Amd.1, +Amd.2, +Amd.3, +Amd.4

EMC

USA

FCC 47CFR Part15B Class B (DoC)

Canada

ICES-003 Class B

European Community

The EMC Directive (89/336/EEC)

EN55022, 1998 Class B

EN55024, 1998

IEC61000-4-2, IEC61000-4-3, IEC61000-4-4, IEC61000-4-5,

IEC61000-4-6, IEC61000-4-8, IEC61000-4-11,

IEC61000-3-2, IEC61000-3-3

Australia/New Zealand

AS/NZS 3548:1995, A1:1997, A2:1997 Class B

CISPR Pub.22:1993, A1:1995, A2:1996, Class B



Appearance

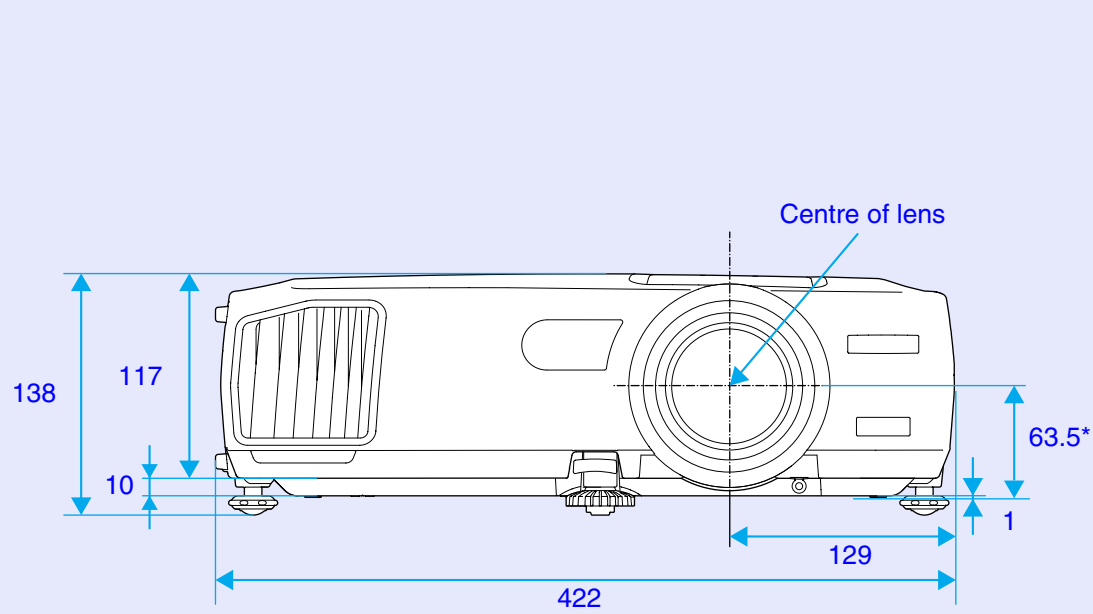

*Distance from centre of lens to suspension bracket fixing point

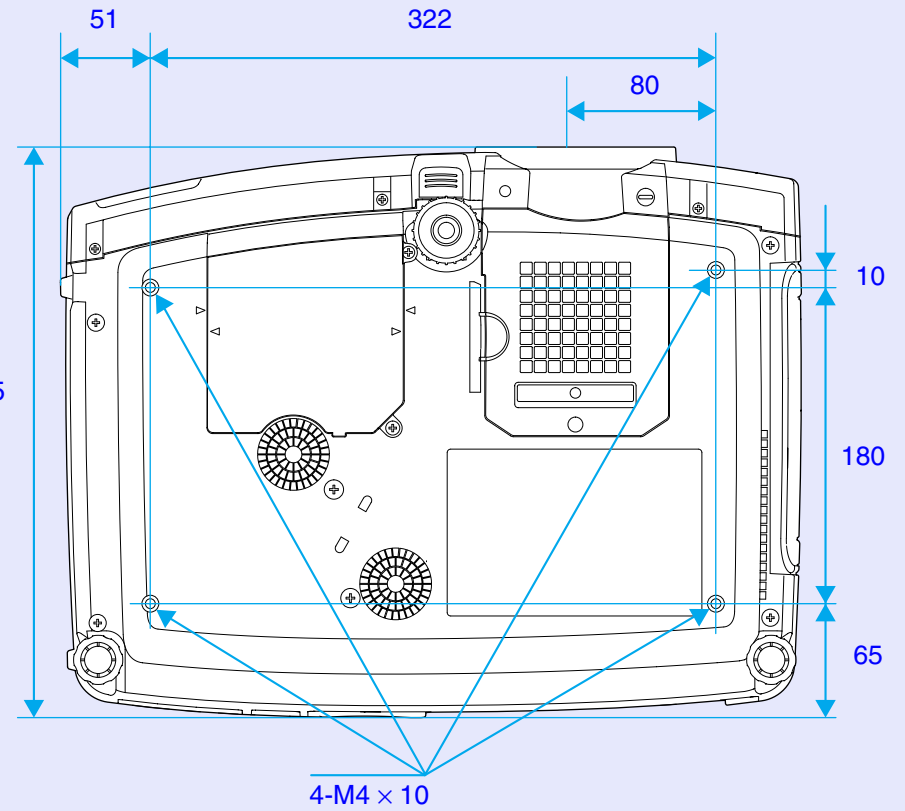

Units: mm



DECLARATION of CONFORMITY

According to 47CFR, Part 2 and 15
Class B Personal Computers and Peripherals; and/or
CPU Boards and Power Supplies used with Class B
Personal Computers

We :EPSON AMERICA, INC.
Located at :3840 Kilroy Airport Way
MS: 3-13
Long Beach, CA 90806
Tel :562-290-5254

Declare under sole responsibility that the product identified herein, complies with 47CFR Part 2 and 15 of the FCC rules as a Class B digital device. Each product marketed, is identical to the representative unit tested and found to be compliant with the standards. Records maintained continue to reflect the equipment being produced can be expected to be within the variation accepted, due to quantity production and testing on a statistical basis as required by 47CFR 2.909. Operation is subject to the following two conditions : (1) this device may not cause harmful interference, and (2) this device must accept any interference received, including interference that may cause undesired operation.

Trade Name :EPSON
Type of Product :Projector
Model :EMP-7850

FCC Compliance Statement For United States Users

This equipment has been tested and found to comply with the limits for a Class B digital device, pursuant to Part 15 of the FCC Rules. These limits are designed to provide reasonable protection against harmful interference in a residential installation. This equipment generates, uses, and can radiate radio frequency energy and, if not installed and used in accordance with the instructions, may cause harmful interference to radio or television reception. However, there is no guarantee that interference will not occur in a particular installation. If this equipment does cause interference to radio and television reception, which can be determined by turning the equipment off and on, the user is encouraged to try to correct the interference by one or more of the following measures.

- Reorient or relocate the receiving antenna.
- Increase the separation between the equipment and receiver.
- Connect the equipment into an outlet on a circuit different from that to which the receiver is connected.
- Consult the dealer or an experienced radio/TV technician for help.

WARNING

The connection of a non-shielded equipment interface cable to this equipment will invalidate the FCC Certification or Declaration of this device and may cause interference levels which exceed the limits established by the FCC for this equipment. It is the responsibility of the user to obtain and use a shielded equipment interface cable with this device. If this equipment has more than one interface connector, do not leave cables connected to unused interfaces. Changes or modifications not expressly approved by the manufacturer could void the user's authority to operate the equipment.



All rights reserved. No part of this publication may be reproduced, stored in a retrieval system, or transmitted in any form or by any means, electronic, mechanical, photocopying, recording, or otherwise, without the prior written permission of SEIKO EPSON CORPORATION. No patent liability is assumed with respect to the use of the information contained herein. Neither is any liability assumed for damages resulting from the use of the information contained herein.

Neither SEIKO EPSON CORPORATION nor its affiliates shall be liable to the purchaser of this product or third parties for damages, losses, costs, or expenses incurred by purchaser or third parties as a result of: accident, misuse, or abuse of this product or unauthorized modifications, repairs, or alterations to this product, or (excluding the U.S.) failure to strictly comply with SEIKO EPSON CORPORATION's operating and maintenance instructions.

SEIKO EPSON CORPORATION shall not be liable against any damages or problems arising from the use of any options or any consumable products other than those designated as Original EPSON Products or EPSON Approved Products by SEIKO EPSON CORPORATION.

General Notice:

EPSON is a registered trademark of SEIKO EPSON CORPORATION.

Macintosh, Mac, and iMac are registered trademarks of Apple Computer, Inc.

IBM is a registered trademark of International Business Machines Corporation.

Windows and Windows NT are trademarks of Microsoft Corporation in the United States of America.

Dolby is registered trademarks of Dolby Laboratories.

Portions of this software are based in part on the work of the Independent JPEG Group.

The freely available TIFF library written by Sam Leffler, Copyright © 1988-1997 Sam Leffler and Copyright © 1991-1997 Silicon Graphics, Inc., is used for loading, drawing and writing the TIFF file.

Other product names used herein are also for identification purposes only and may be trademarks of their respective owners. EPSON disclaims any and all rights in those marks.

This product uses open source software.