





EPSON®

M M PROJECTOR
ULTI EDIA

User's Guide

EMP-8300



 CAUTION	Indicates procedures which may result in damage or injury if sufficient care is not taken.
 TIP	Indicates additional information and points.
	Indicates a page where useful information regarding a topic can be found. Click on the page number to display that page.
	Indicates that an explanation of the underlined word or words in front of this symbol appears in the glossary of terms. Click the underlined word or words to display the corresponding entry in the "Glossary" section of the "Appendices".  p.134
PROCEDURE	Indicates operating methods and the order of operations. The procedure indicated should be carried out in the order of the numbers.

When "unit" or "projector" appears in the text of this *User's Guide*, it may refer to items which are accessories or optional equipment in addition to the main projector unit itself.

Position adjustment function for a variety of projection screens

Images can be projected regardless of the location.

- If the screen is in a high position or the projector is suspended from a high ceiling.

The position of the projected images can be adjusted vertically. (Lens shift function [p.45](#))

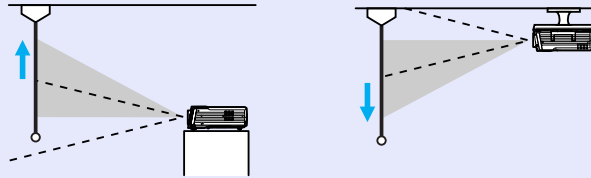

The projector can be tilted using the front adjustable feet, and the keystone distortion in the projected images that occurs as a result of this can also be corrected. (Vertical keystone correction [p.49](#))

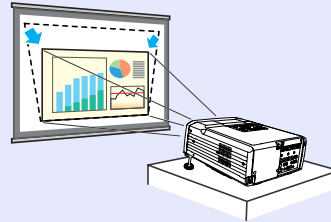

If vertical keystone correction causes the height of projected images to be too short, the height of the projection area can also be adjusted. (Height correction [p.50](#))



- When projecting from the side of the screen

The Quick Corner function can be used to correct the four corners of the projection area to make the images fit the screen exactly. [p.47](#)



Projector monitoring and control functions using a network

Multiple projectors can be monitored and operations such as turning the power on and off and changing the input signal source can be carried out over a network by a single operator sitting at a computer. (EMP Monitor [p.92](#))

In addition, if a problem occurs with a projector, such as a lamp blowing while projection is in progress, e-mail notification messages can be sent by the projector to notify someone of the problem. (Mail notification function [p.96](#))

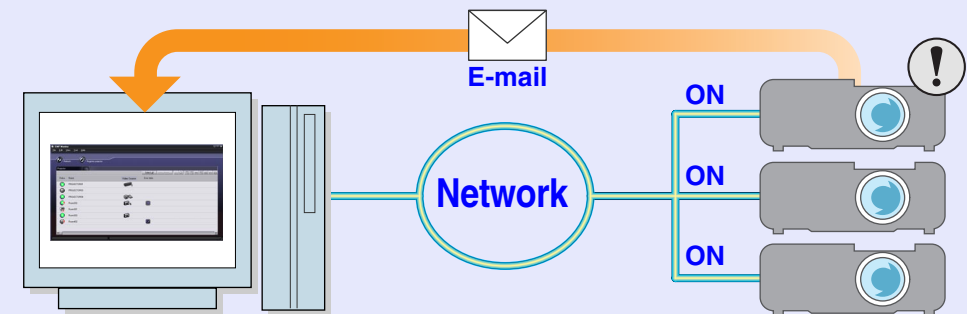

Colour mode function

Optimum images can be projected simply by selecting the image quality from the following five preset settings according to the projection environment being used. No other colour adjustments are necessary.

☛ p.55

- Dynamic • Presentation • Theatre • Living Room • [sRGB](#)

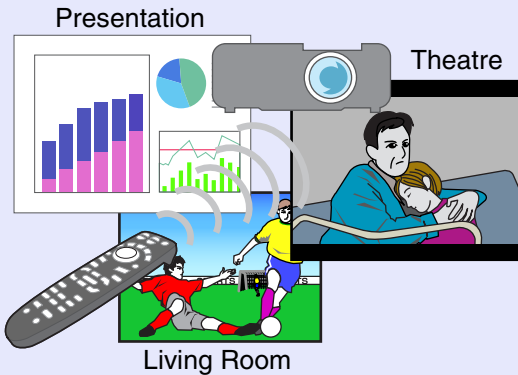

Effects functions

These functions allow you to indicate important points using a pointer and draw straight lines and freehand curves to help make explanations easier to understand. ☛ p.62

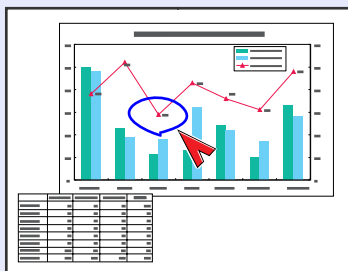

Brilliant, attractive images

The projector can display images at high resolutions with a high degree of luminance.

In addition, images can be switched to low luminance if they are too bright when projecting in dark rooms or onto small screens. ☛ p.86



Easy to operate

The remote control can be used for operations such as pausing projection (Freeze Function ☛ p.59) and zooming in on important areas of an image (E-Zoom Function ☛ p.59). In addition, the remote control can be used to move the pointer around on the computer screen during projection (Wireless Mouse Function ☛ p.23). If using the wireless mouse function, you can use the remote control to scroll back and forth through slides when projecting a PowerPoint presentation.

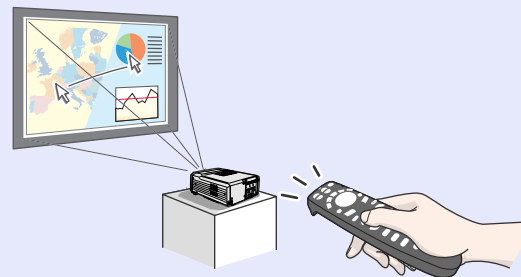

Notations Used in This User's Guide.....	1
Features of the Projector	2

Before Using the Projector

Part Names and Functions.....	7
Front/Top/Side	7
Base.....	8
Rear	8
Control Panel	9
Remote Control.....	10
Input/Output Ports.....	11
Before Using the Remote Control.....	12
Inserting the Batteries	12
Using the Remote Control and Remote Operating Range	13
Installation	15
Setting Up the Projector.....	15
Screen Size and Projection Distance.....	16
Connecting to a Computer	17
Eligible Computers	17
Projecting Images from the Computer.....	18
If Connecting More Than One Computer.....	22
Using the Remote Control to Operate the Mouse	
Pointer (Wireless Mouse Function)	23
Connecting to a Video Source.....	25
Projecting Composite Video Images.....	25
Projecting S-Video Images	26
Projecting Component Video Images	26
Projecting RGB Video Images.....	27
Playing Sound from the Video Equipment.....	29
Playing Sound from External Speakers.....	31

Connecting to an External Monitor.....	32
Connecting an External Monitor	32
Checking Projected Images on an External Monitor	
While the Projector is at Standby (Standby Monitor Out)	33
Installing the Cable Cover	34

Basic Operations

Turning the Projector On	36
Connecting the Power Cable	36
Turning the Power On and Projecting Images.....	37
Selecting an Image Source While Viewing Projected	
Images (Preview Function)	39
Turning the Projector Off	41
Adjusting the Screen Image.....	43
Adjusting the Image Size (Zoom Function).....	43
Focusing the Screen Images (Focus Adjustment).....	44
Adjusting the Image Angle	44
Correcting Distortion in the Projection Area	
(Keystone Correction).....	47
Adjusting the Image Quality	52
Adjusting Computer Images.....	52
Selecting the Projection Quality (Colour Mode Selection).....	55
Adjusting the Volume	56



Advanced Operations

Functions for Enhancing Projection.....	58
A/V Mute Function	58
Freeze Function.....	59
E-Zoom Function	59
P in P (Picture in Picture) Function	60
Effect Function.....	62
Preset Function.....	64
Changing the Resize/Aspect Ratio.....	66
Projector ID/Remote Control ID.....	69
Using the Configuration Menu Functions	72
List of Functions	73
Using the Configuration Menus	90
Projector Monitoring and Control using a Network.....	92
Compatible Computers	92
Installing and Uninstalling the Projector Software	93
Network Cable Connections	94
Projector Connection Settings.....	95
Problem Reporting Using the Mail Notification Function.....	96
Centralised Monitoring and Controlling of Projectors (EMP Monitor)	101

Troubleshooting

Using the Help	107
Problem Solving	109
Reading the Indicators.....	109
When the Indicators Provide No Help	112

Appendices

Maintenance	122
Cleaning	122
Replacing Consumables	123
Saving a User's Logo	129
Optional Accessories	132
Glossary.....	134
List of ESC/VP21 Commands	137
Command List	137
Communication Protocol.....	137
Cable Layouts.....	138
USB Connection Setup.....	139
List of Supported Monitor Displays	140
Specifications	141
Appearance.....	143
Index	144













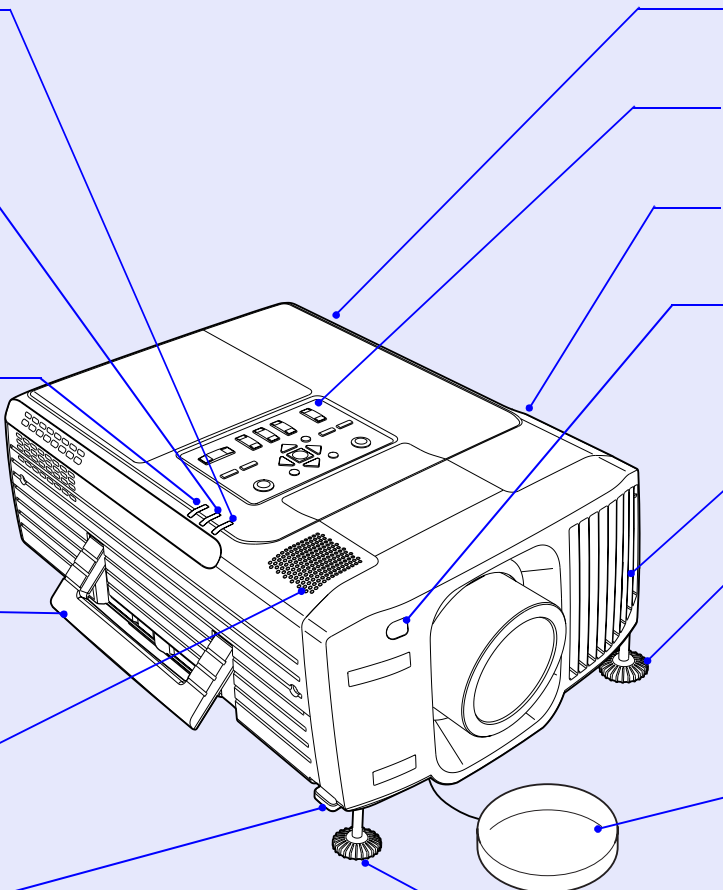

Before Using the Projector

This chapter describes the procedures for setting up the projector before use.

Part Names and Functions.....	7	• If Connecting More Than One Computer.....	22
• Front/Top/Side	7	• Using the Remote Control to Operate the Mouse Pointer (Wireless Mouse Function)	23
• Base.....	8	Connecting to a Video Source	25
• Rear	8	• Projecting Composite Video Images	25
• Control Panel	9	• Projecting S-Video Images.....	26
• Remote Control	10	• Projecting Component Video Images	26
• Input/Output Ports.....	11	• Projecting RGB Video Images.....	27
Before Using the Remote Control	12	• If the RGB Output Port is a Mini D-Sub 15-pin Port	27
• Inserting the Batteries	12	• If the RGB Output Ports are the 3BNC Ports	28
• Using the Remote Control and Remote Operating Range	13	Playing Sound from the Video Equipment.....	29
• Using the Remote Control.....	13	Playing Sound from External Speakers	31
• Remote Operating Range	14	Connecting to an External Monitor	32
Installation	15	• Connecting an External Monitor	32
• Setting Up the Projector	15	• Checking Projected Images on an External Monitor While the Projector is at Standby (Standby Monitor Out)	33
• Screen Size and Projection Distance.....	16	Installing the Cable Cover	34
Connecting to a Computer.....	17	• Installation	34
• Eligible Computers	17	• Removal	34
• Projecting Images from the Computer.....	18		
• If the Monitor Port is a Mini D-Sub 15-pin Port.....	18		
• If the Monitor Port is a 13w3 Port	19		
• If the Monitor Ports are the 5BNC Ports.....	20		
• If the Monitor Port is a Digital RGB Port.....	21		

The illustration below shows the projector with a standard lens fitted.

Front/Top/Side

- 
- **⏻ (Operation) indicator**  [p.109](#)
Flashes or lights in different colours to indicate the operating status of the projector.
 - **☼ (Lamp) indicator**  [p.109](#)
Flashes or lights in different colours to indicate problems with the projection lamp.
 - **⚠ (Temperature) indicator**  [p.109](#)
Flashes or lights in different colours to indicate problems with the internal temperature of the projector.
 - **Handle**
Use this handle when lifting and transporting the projector.
 - **Speaker**
 - **Foot adjust lever**  [p.46](#)
Another foot adjust lever is located on the right side.
Pull both foot adjust levers when extending and retracting the front adjustable feet.
 - **Air intake vent**  [p.123](#)
 - **Control panel**  [p.9](#)
 - **Security lock (🔒)**  [p.135](#)
 - **Remote control light-receiving area**  [p.13](#)
Receives signals from the remote control.
 - **Air exhaust vent**
 - **Front adjustable foot**  [p.46](#)
Extend and retract to adjust the projection angle when the projector is placed on a surface such as a shelf.
 - **Lens cover**
Attach when not using the projector in order to prevent the lens from becoming dirty or damaged.
 - **Front adjustable foot**  [p.46](#)
Extend and retract to adjust the projection angle when the projector is placed on a surface such as a shelf.

Base

- **Suspension bracket fixing points (4 points)**  [p.15](#), [p.133](#)

Connect an optional ceiling mount here when suspending the projector from the ceiling.

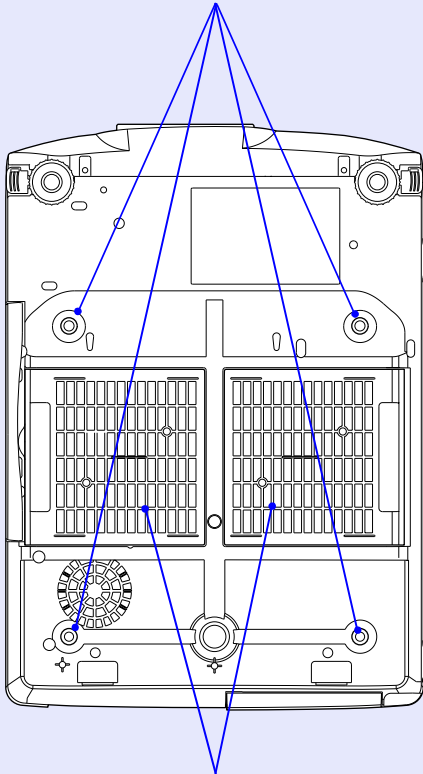

- **Air filters (2 places) (air intake vents)**  [p.122](#), [p.127](#)

Prevent dust and other foreign particles from being drawn into the projector. Clean the air filters periodically.

Rear

- **Input/output ports**  [p.11](#)

- **Lamp cover**  [p.124](#)

Open this cover when replacing the lamp inside the projector.

- **Power inlet**  [p.36](#)

Connect the power cable here.

- **Remote control light-receiving area**  [p.13](#)

Receives signals from the remote control.

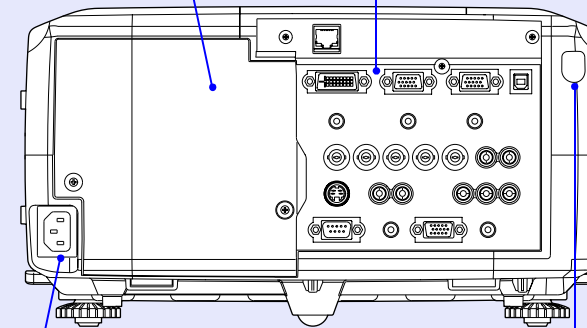

Control Panel

Buttons with no description are the same as the remote control buttons. Refer to the remote control descriptions for details.

- **[Auto/Enter] button**  p.52, p.90, p.107

Operates in the same way as the [Auto] button on the remote control.

When pressed while a configuration menu or help menu is being displayed, it operates in the same way as the [Enter] button on the remote control.

- **[Sync +] and [Sync -] buttons**  p.54, p.90, p.107

Press these buttons to manually adjust the [sync](#) of computer images.

When pressed while a configuration menu or help menu is being displayed, these buttons function as [▲] and [▼] (up and down) buttons for selecting items in the menu.

- **[Tracking +] and [Tracking -] buttons**  p.53, p.91, p.107

Press these buttons to manually adjust the [tracking](#) of computer images.

When pressed while a configuration menu or help menu is being displayed, these buttons function as [◀] and [▶] (left and right) buttons for selecting items in the menu.

- **[Menu] button**  p.90

- **[Power] button**  p.37, p.41

- **[Source] buttons**  p.38

[Computer/DVI] button:

Switches the input source between the [Computer 1] port, [Computer 2] port and [DVI] port in that order each time the button is pressed.

[Video/BNC] button:

Switches the input source between the [S-Video] port, [Video] port and the [BNC] ports in that order each time the button is pressed.

- **[Keystone] button**  p.49

Press to manually correct vertical keystone distortion in images.

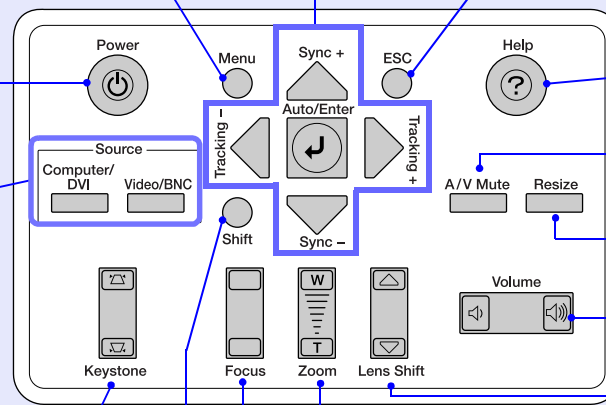

- **[ESC] button**  p.91, p.107

- **[Help] button**  p.107

- **[A/V Mute] button**  p.58

- **[Resize] button**  p.66

- **[Volume] button**  p.56

- **[Lens Shift] button**  p.45

- **[Zoom] button**  p.43

- **[Focus] button**  p.44

- **[Shift] button**  p.49, p.67

This button is used when using the Quick Corner function and the resize function.

Remote Control

If you position the  over the button icon or button name, a description of that button will appear.

- Remote control light-emitting area  p.14

- Indicator

- [Page] buttons  p.23

- [E-Zoom] buttons  p.59

- [Color Mode] button  p.55

- [PinP] button  p.60

- [☀] (illumination) button

- [Menu] button  p.90

- [Enter (↵)] button  p.24, p.90, p.107

- [Preset] button  p.64

- [Preview] button  p.39

- [Focus] buttons  p.44

- [Volume] buttons  p.56

- [Num] button  p.95

- [Remote] port  p.14, p.132

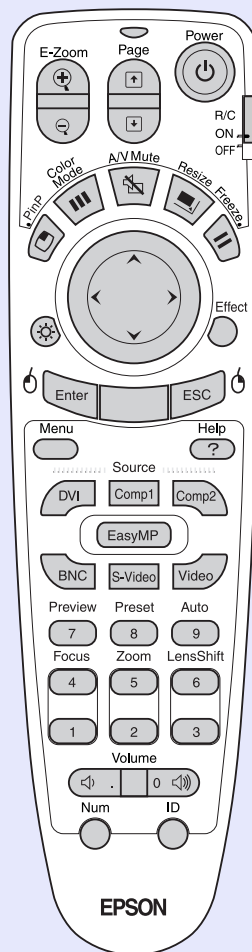

- [Power] button  p.37, p.41

- [R/C] switch  p.13

- [A/V Mute] button  p.58

- [Resize] button  p.66

- [Freeze] button  p.59

- [☀] button  p.24, p.90, p.107

- [Effect] button  p.62

- [ESC (↵)] button  p.24, p.91, p.107

- [Help] button  p.107

- [Source] buttons  p.38

- [Auto] button  p.52

- [Lens Shift] buttons  p.45

- [Zoom] buttons  p.43

- Numeric buttons  p.70, p.95

- [ID] button  p.70

Input/Output Ports

• [Computer 1] port [p.18](#), [p.22](#), [p.27](#)

Inputs analogue-RGB signals from a computer and RGB-video signals from video equipment.

• [Audio] port (for [Computer 1] port) [p.29](#)

Inputs audio signals from the source that is connected to the [Computer 1] port.

• Network port [p.94](#)

Use to connect the projector to a network.

• [DVI] port [p.21](#), [p.22](#)

Inputs digital RGB computer video signals.

• [Audio] port (for [DVI] port) [p.29](#)

Inputs audio signals from the source that is connected to the [DVI] port.

• [BNC] ports [p.21](#), [p.22](#), [p.26](#)

Inputs analogue-RGB signals from a computer and RGB-video signals and [component video](#) signals from video equipment.

• [Audio] ports (for [BNC] ports) [p.29](#)

Input audio signals from the source that is connected to the [BNC] ports.

• [S-Video] port [p.26](#)

Inputs [S-Video](#) signals from a video source.

• [Audio] ports (for [S-Video] port) [p.29](#)

Input audio signals from the source that is connected to the [S-Video] port.

• [Control (RS-232C)] port [p.138](#)

Connects the projector to a computer using an RS-232C cable. This port is for control use and should not be used by the customer.

• [Computer 2] port

[p.18](#), [p.22](#), [p.27](#)

Inputs analogue-RGB signals from a computer and RGB-video signals from video equipment.

• [Audio] port (for [Computer 2] port) [p.29](#)

Inputs audio signals from the source that is connected to the [Computer 2] port.

• [USB] port [p.23](#), [p.138](#)

Connects the projector to a computer via the USB cable when using the wireless mouse function.

• [Video] port [p.25](#)

Inputs [composite video](#) signals from a video source.

• [Audio] ports (for [Video] port) [p.29](#)

Input audio signals from the source that is connected to the [Video] port.

• [Audio Out] port [p.31](#)

Outputs the audio signals from the selected video source to external speakers.

• [Monitor Out] port [p.32](#)

Outputs the video signals from the selected video source to an external monitor.

• [Remote] port [p.14](#), [p.132](#)

Connect the optional remote control cable set to input signals from the remote control.

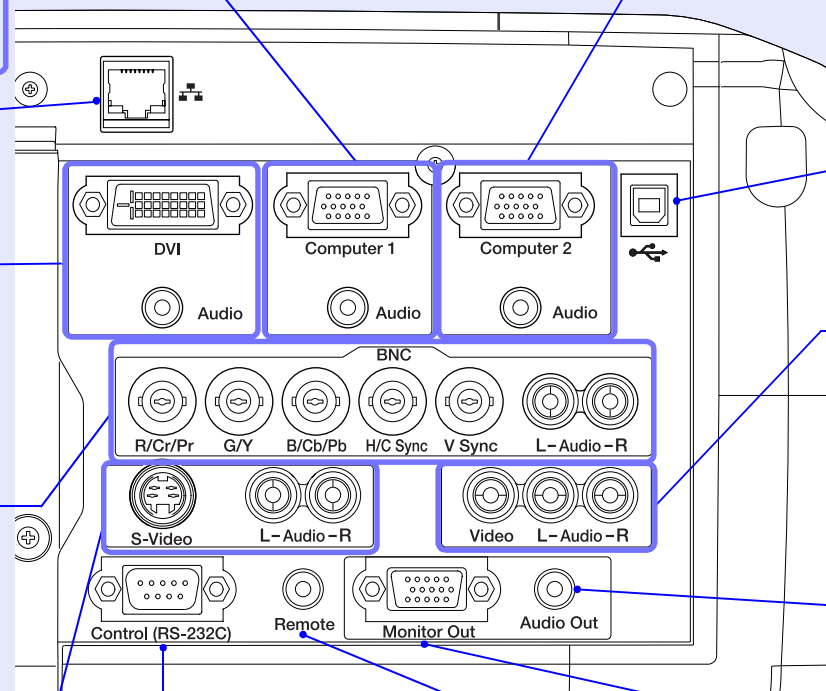

Inserting the Batteries

The batteries are not already inserted into the remote control at the time the projector is purchased. You will need to insert the batteries that are provided with the projector before the remote control can be used.

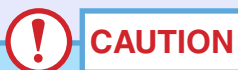

CAUTION

Be sure to read the Safety Instructions/World-Wide Warranty Terms before handling the batteries.

PROCEDURE

1 Remove the battery cover.

While pushing down on the rib of the battery cover, slide the battery cover in the direction of the arrow.

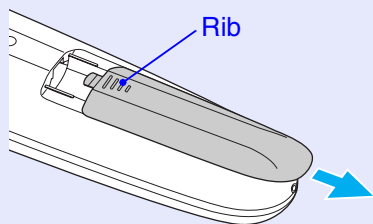

2

2 Insert the batteries.

Check the positions of the (+) and (-) marks inside the battery holder to ensure that the batteries are inserted the correct way.

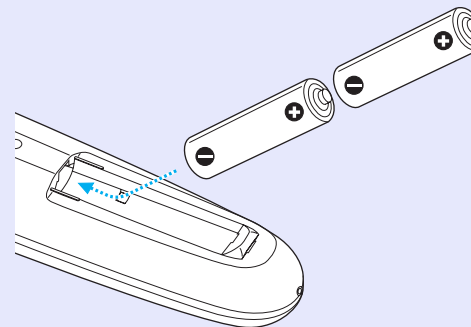

3

3 Replace the battery cover.

Slide the battery cover in until the tab clicks into place.

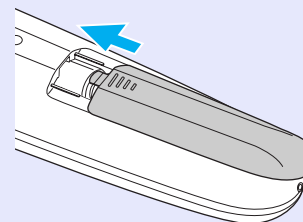

TIP

If delays in the responsiveness of the remote control occur or if it does not operate after it has been used for some time, it probably means that the batteries are becoming flat. If this happens, replace the batteries with two new AA alkali batteries.

Using the Remote Control and Remote Operating Range

Using the Remote Control

The remote control is used in the following way.

PROCEDURE

- 1 Set the [R/C] switch of the remote control to "ON".

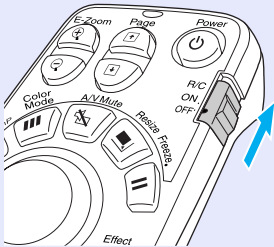

- 2 Point the remote control light-emitting area towards one of the remote control light-receiving areas on the projector and operate the remote control buttons.

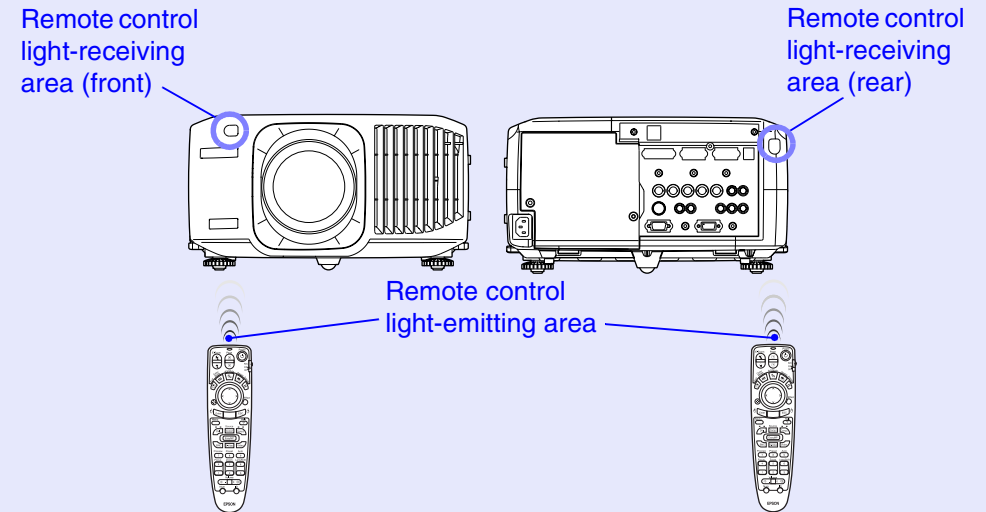

TIP

- Do not allow sunlight or light from fluorescent lamps to shine directly onto the projector's remote control light-receiving areas, otherwise it may interfere with the reception of signals from the remote control.
- When not using the remote control, set the [R/C] switch on the remote control to "OFF". If you leave the [R/C] switch at "ON", it will consume battery power.
- If a button on the remote control is pressed down for more than 1 minute while the [R/C] switch is at "ON", the signal for that button operation will stop being transmitted (the remote control will change to sleep mode). The purpose of this is to prevent the batteries from being consumed due to something being placed on top of the remote control. When the button is released, normal remote control operation will resume.

Remote Operating Range

Use the remote control within the ranges indicated below. If the distance or angle between the remote control and the remote control light-receiving area is outside the normal operating range, the remote control may not work.

Operating distance	Operating angle
Approx. 10 m (30 ft.)	Approx. $\pm 30^\circ$ horizontally Approx. $\pm 15^\circ$ vertically

Operating angle (horizontal)

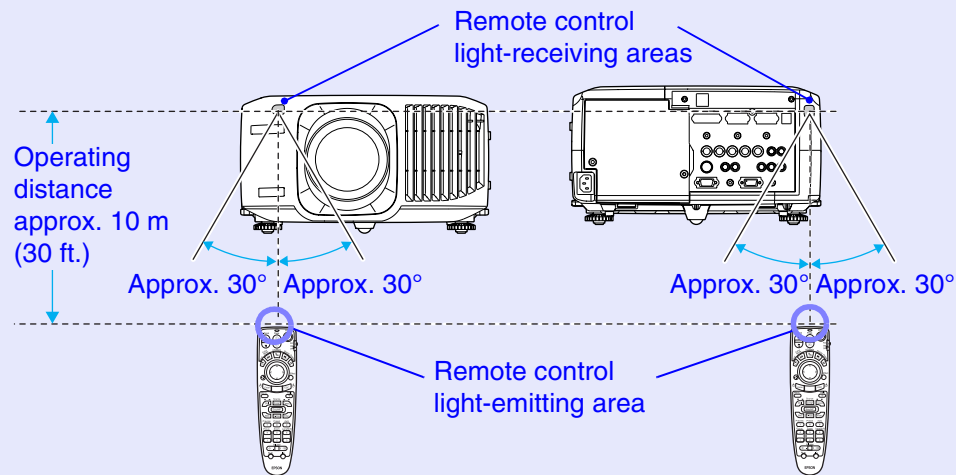

Operating angle (vertical)

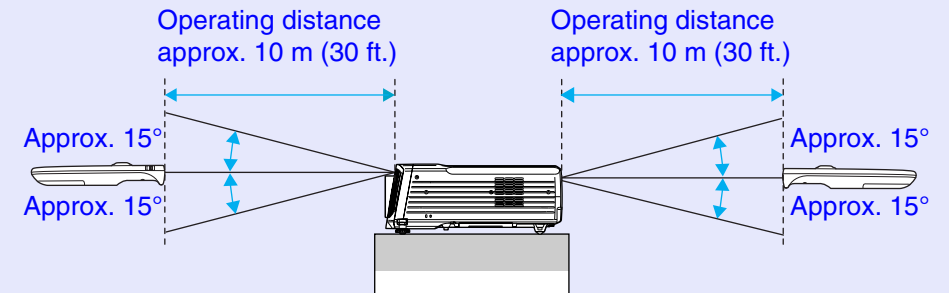

When suspended from the ceiling

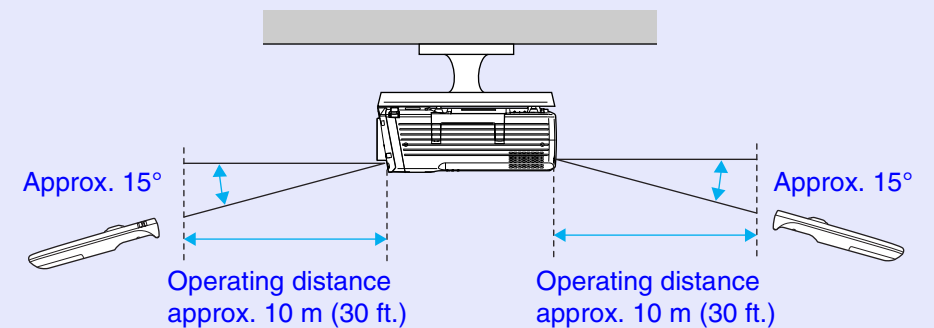

TIP

If you would like to ensure that remote control operations work properly from a distance, use the optional remote control cable set to connect the [Remote] port of the remote control to the projector's [Remote] port.

See "Appendices: Optional Accessories" [p.132](#)

Setting Up the Projector

The projector supports the following four different projection methods, allowing you to choose the best method for displaying your images.



CAUTION

Before setting up the projector, be sure to first read the separate Safety Instructions/World-Wide Warranty Terms.

- Front projection

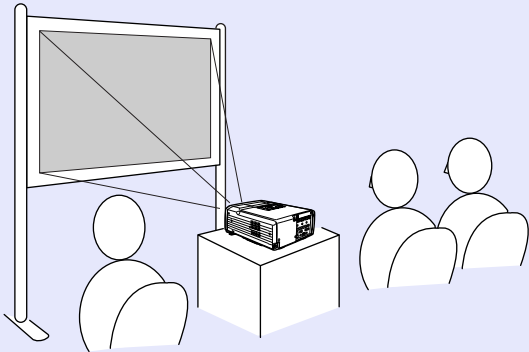

- Rear projection using a translucent screen

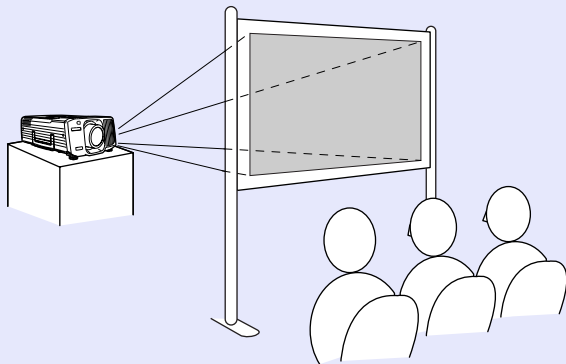

- Front/ceiling projection

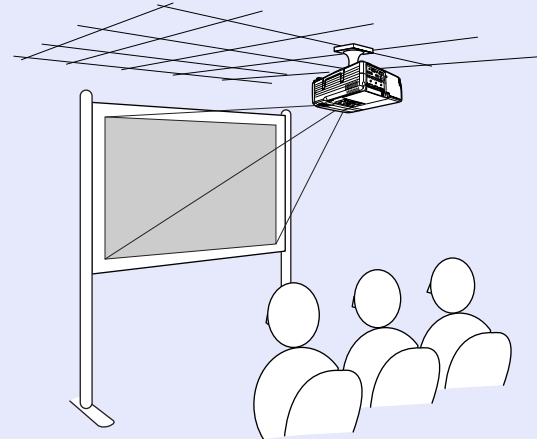

- Rear/ceiling projection using a translucent screen

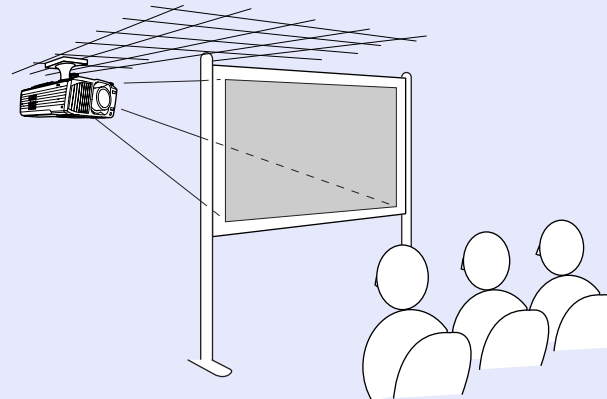

* A special method of installation is required for suspending the projector from the ceiling. Please contact your supplier if you would like to use this installation method. The optional ceiling mount is required when installing the projector on the ceiling.

[p.133](#)



TIP

When using rear/ceiling projection using a translucent screen, set the "Ceiling" and "Rear Proj." commands in the "Advanced1" menu to match the installation method. [p.84](#), [p.85](#)

Screen Size and Projection Distance

The distance from the lens to the screen determines the actual image size. The recommended distance and projection distance values given below are for when the projector is fitted with a standard lens. If the projector has been fitted with an optional lens, refer to the documentation provided with the lens.

Recommended distance	104–1543 cm (3.4–50.6 ft.)
-----------------------------	----------------------------

While referring to the following table, position the projector so that the images are projected onto the screen at the optimum size. The values should be used as a guide for setting up the projector. The actual values will vary depending on projection conditions and the zoom setting.

4:3 screen size (cm (in.))	Projection distance (cm (ft.))
30" (61 × 46 (24.0 × 18.1))	104–146 (3.4–4.8)
40" (81 × 61 (31.9 × 24.0))	142–197 (4.7–6.5)
60" (120 × 90 (47.2 × 35.4))	217–301 (7.1–9.9)
80" (160 × 120 (63.0 × 47.2))	293–404 (9.6–13.3)
100" (200 × 150 (78.7 × 59.1))	369–508 (12.1–16.7)
200" (410 × 300 (161.4 × 118.1))	747–1025 (24.5–33.6)
300" (610 × 460 (240.2 × 181.1))	1126–1543 (36.9–50.6)

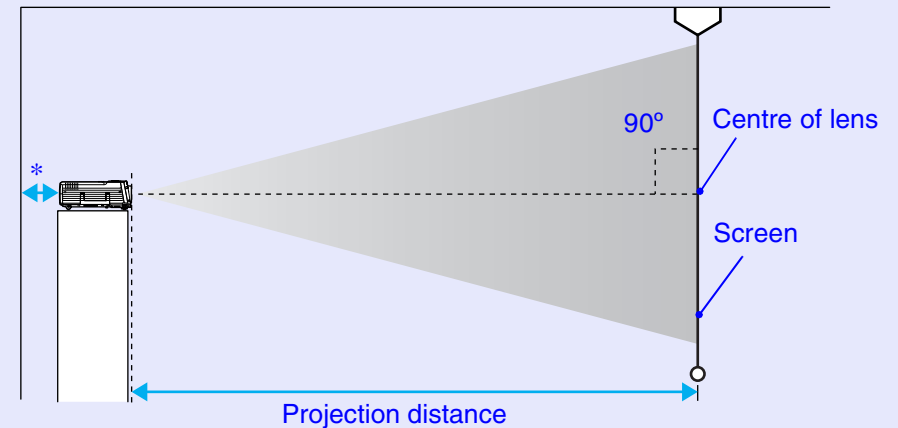

The distance from the centre of the lens to the bottom will vary depending on the lens shift status. [p.45](#)

* When installing against a wall, leave a space of 20 cm (7.9 in.) or more between the projector and the wall.



TIP

The standard lens allows a zoom ratio of up to about 1.35. The image size at the maximum zoom setting is about 1.35 times bigger than the image size at the minimum zoom setting.

CAUTION

When connecting the projector to a computer, be sure to check the following.

- *Turn the power off for both the projector and the computer before connecting them. If the power for either device is on at the time of connection, damage may result.*
- *Check the shapes of the cable connectors and the device ports before making the connections. If you try to force a connector to fit a device port with a different shape or number of terminals, a malfunction or damage to the connector or port may result.*
- *Do not bind the power cable and the connecting cable together. If the power cable and the connecting cable are bound together, image interference or errors in operation may result.*

Eligible Computers

The projector cannot be connected to some types of computer, or projection of images may not be possible even if actual connection is possible. Make sure that the computer you intend to use satisfies the conditions given below.

- **Condition 1:** The computer must have an image signal output port. Check that the computer has a port such as an "RGB port", "monitor port" or "CRT port" which can output image signals.
If the computer has a built-in monitor, or if using a laptop computer, it may not be possible to connect the computer to the projector, or alternatively you may need to purchase a separate external output port. Refer to the documentation for your computer under a heading such as "Connecting an external monitor" or similar for further details.

- **Condition 2:** The display resolution and frequency of the computer must be listed in the "List of Supported Monitor Displays". See "Appendices: List of Supported Monitor Displays"  p.140
Some computers allow you to change the output resolution, so if necessary, change the resolution to one that matches a setting in the "List of Supported Monitor Displays". Refer to the documentation provided with the computer.

TIP

- *You may need to purchase a commercially-available adapter depending on the shape of the computer's port. Refer to the documentation provided with the computer for further details.*
- *If the computer and projector are too far away from each other for the accessory computer cable to reach, use the optional VGA-HD15 PC cable. See "Appendices: Optional Accessories"  p.132*

Projecting Images from the Computer

The shape and specifications of the computer's monitor port will determine what type of cable should be used. Check the following to see which type of port your computer has.

■ If the Monitor Port is a Mini D-Sub 15-pin Port

Use the accessory computer cable to make the connections.

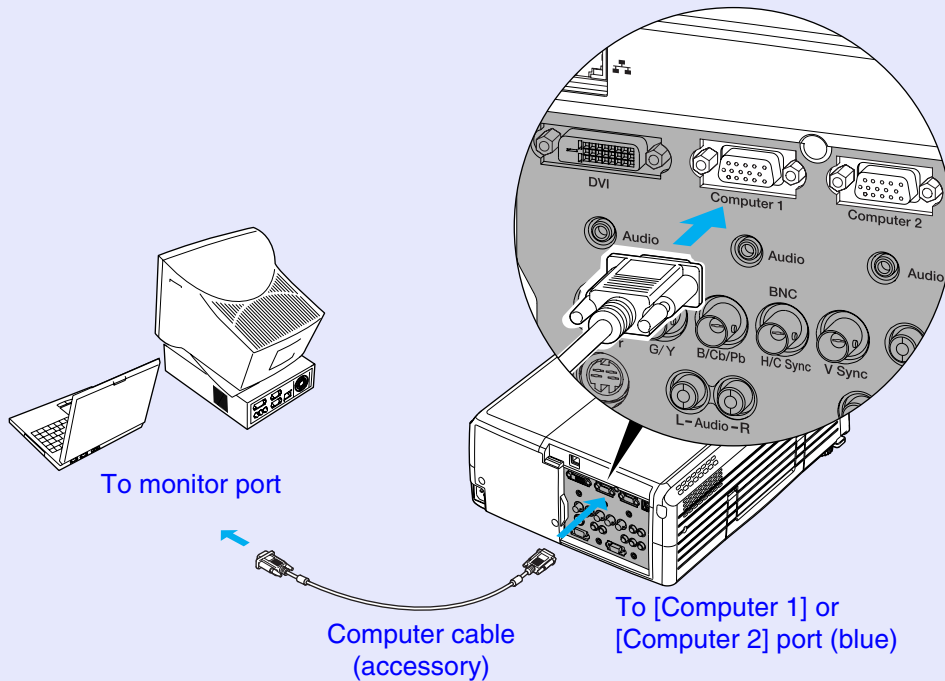

TIP

- After projection starts, change the "Computer1 Input" or "Computer2 Input" setting in the "Setting" menu to "Analog-RGB". [p.80](#)
- If more than one external component is connected to the projector, press the [Comp1] or [Comp2] button on the remote control after projection starts, or repeatedly press the [Computer/DVI] button on the projector's control panel to select the signal to be projected. [p.38](#)

■ If the Monitor Port is a 13w3 Port

Some workstation-type computers have a 13w3 monitor port.
In such cases, use a commercially-available 13w3 ⇔ D-Sub 15-pin cable to make the connection.

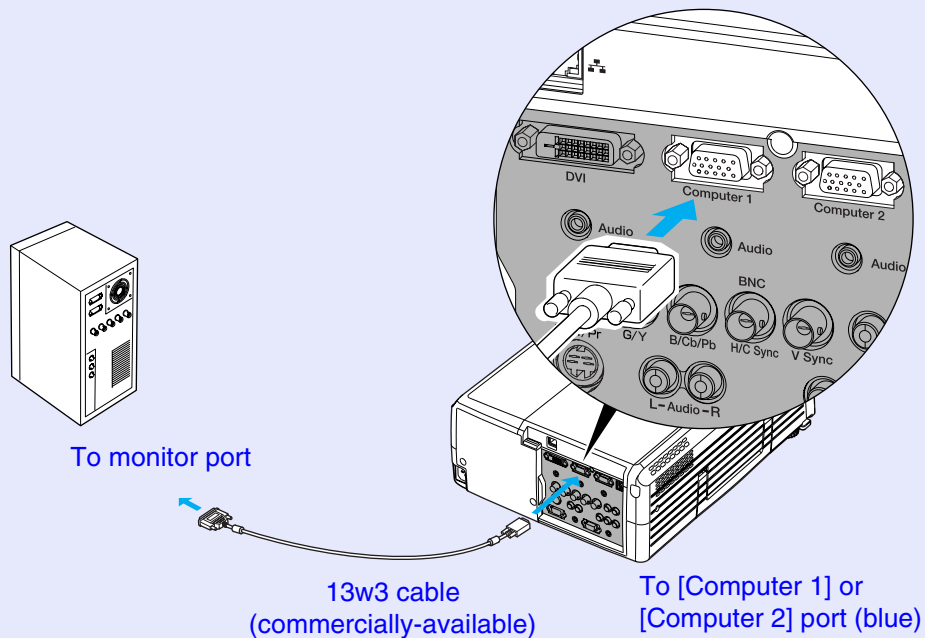

TIP

- After projection starts, change the "Computer1 Input" or "Computer2 Input" setting in the "Setting" menu to "Analog-RGB". [p.80](#)
- If more than one external component is connected to the projector, press the [Comp1] or [Comp2] button on the remote control after projection starts, or repeatedly press the [Computer/DVI] button on the projector's control panel to select the signal to be projected. [p.38](#)
- Some workstations may require a special cable. Consult the workstation manufacturer for further details.

If connecting to the [BNC] ports

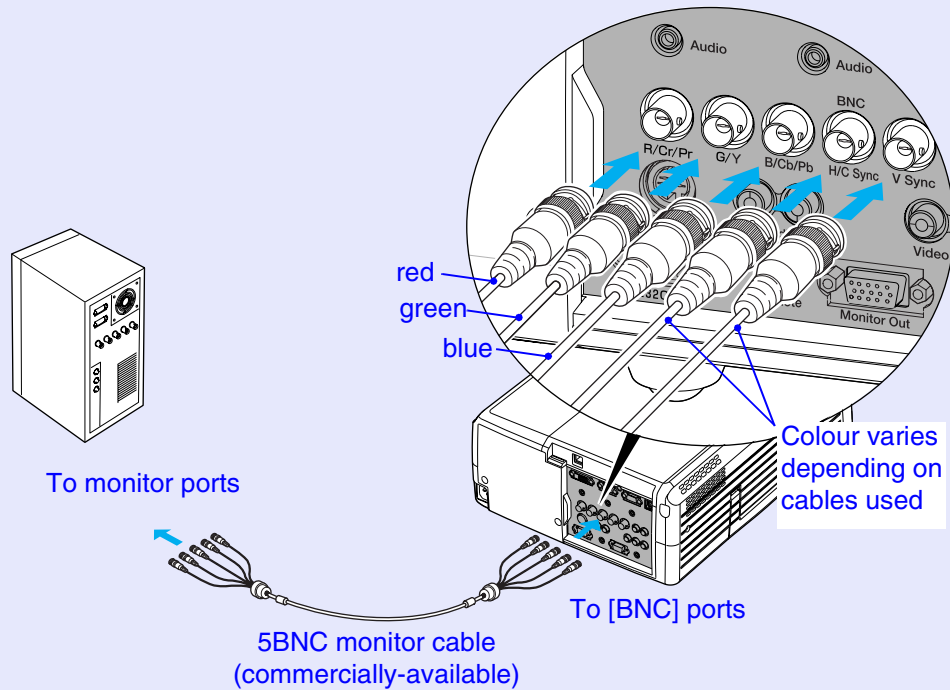

If the Monitor Port is a Digital RGB Port

Use the optional [DVI-D](#)™/DVI-D digital video cable or DVI-D/DFP digital video cable to make the connection.

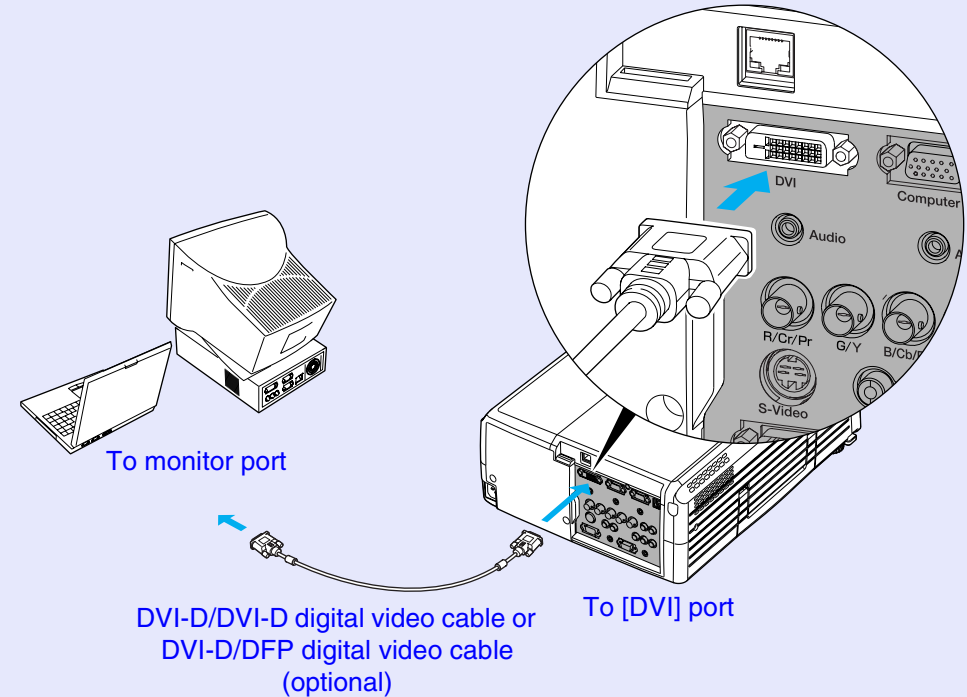

TIP

- After projection starts, change the "BNC Input" setting in the "Setting" menu to "Analog-RGB". [p.81](#)
- If more than one external component is connected to the projector, press the [BNC] button on the remote control after projection starts, or repeatedly press the [Video/BNC] button on the projector's control panel until "BNC (Analog-RGB)" is displayed on the projected image to select the signal to be projected. [p.38](#)

TIP

- Use whichever optional DVI-D/DVI-D digital video cable or DVI-D/DFP digital video cable matches the monitor port of the computer. See "Appendices: Optional Accessories" [p.132](#)
- If more than one external component is connected to the projector, press the [DVI] button on the remote control after projection starts, or repeatedly press the [Computer/DVI] button on the projector's control panel until "DVI" is displayed on the projected image to select the signal to be projected. [p.38](#)

If Connecting More Than One Computer

The ports shown below can be used to connect computers to the projector. If computers are connected to all of the ports shown below, a maximum of four computers can be connected.

Connection details [p.17–p.21](#)

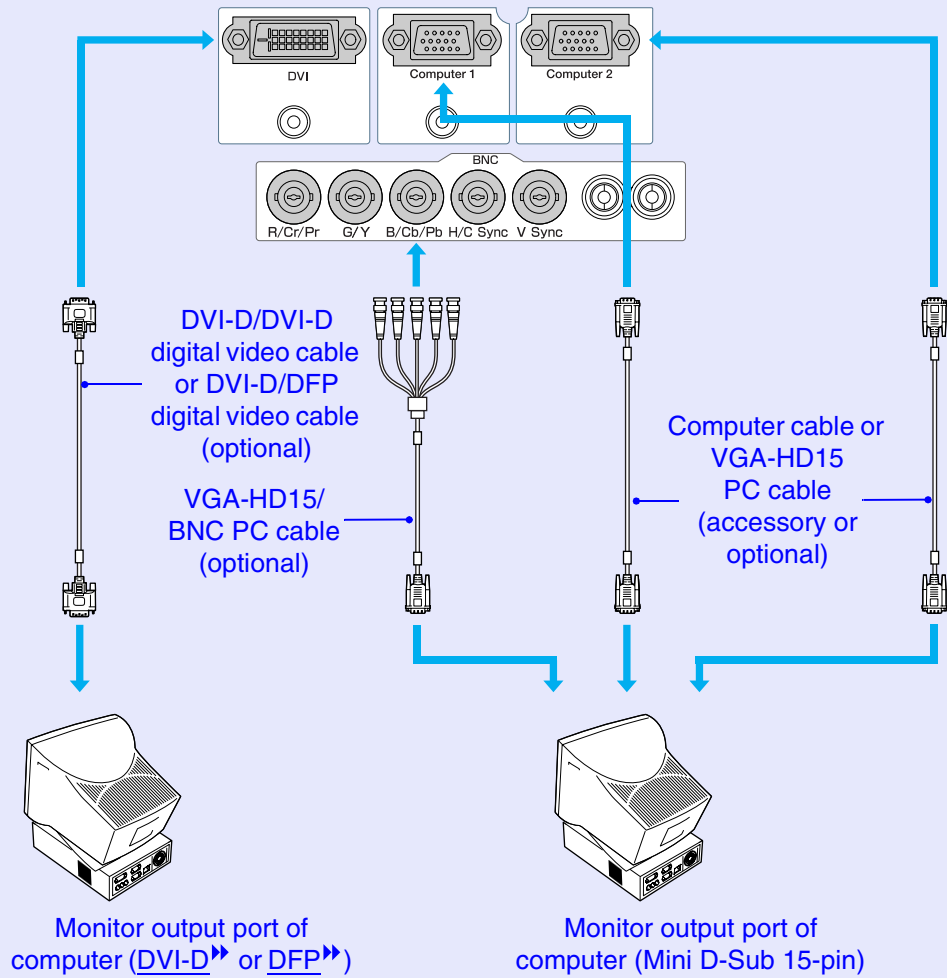

Using the Remote Control to Operate the Mouse Pointer (Wireless Mouse Function)

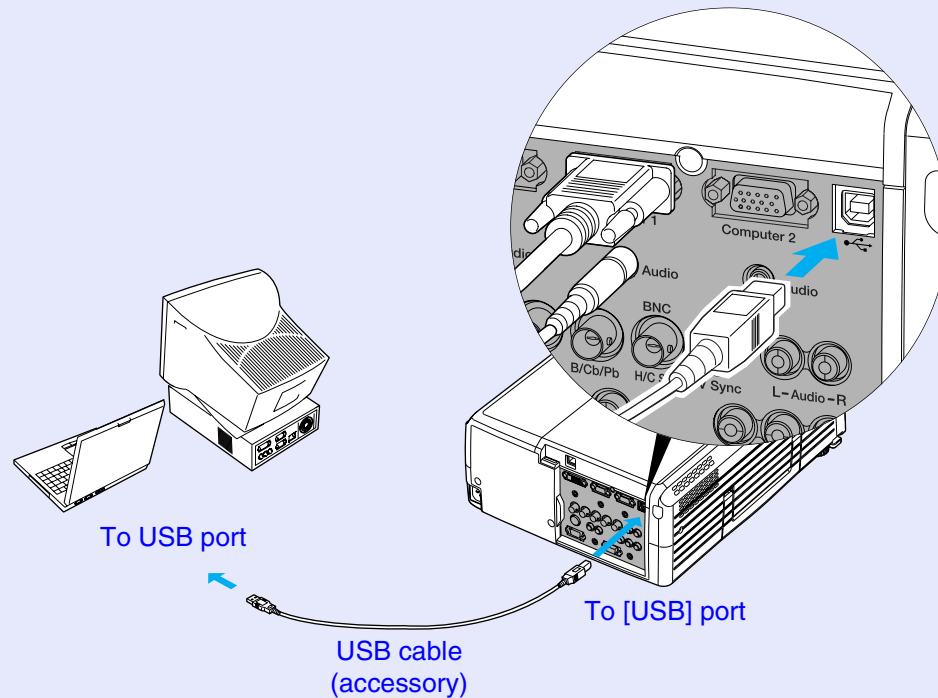

You can use the remote control as a wireless mouse to control the mouse pointer on the screen by using the accessory [USB](#) cable to connect the USB port of the computer to the [USB] port at the rear of the projector.

Computer	Mouse used	Applicable cable
Windows 98/2000/Me/XP Home Edition/XP Professional	USB mouse	USB cable (accessory)
Macintosh (OS 8.6–9.2/10.0–10.2)	USB mouse	USB cable (accessory)



TIP

- *The USB cable can only be connected to computers with a standard USB interface. If using a computer which is running Windows, the computer must have had a full version of Windows 98/2000/Me/XP Home Edition/XP Professional installed. If the computer is running a version of Windows 98/2000/Me/XP Home Edition/XP Professional that has been upgraded from an earlier version of Windows, correct operation cannot be guaranteed.*
- *It may not be possible to use the wireless mouse function under some versions of both the Windows and Macintosh operating systems.*
- *Some computer settings may have to be changed in order for the mouse function to be used. Consult the documentation for the computer for further details.*

* When using the remote control as a wireless mouse, the [Page ] and [Page ] buttons on the remote control can be used to scroll back and forth through slides when projecting a PowerPoint presentation.



Once the connection has been made, the mouse pointer can be operated as follows.

Moving the mouse pointer

Tilt the [○] button on the remote control to move the mouse pointer in the direction of tilt.

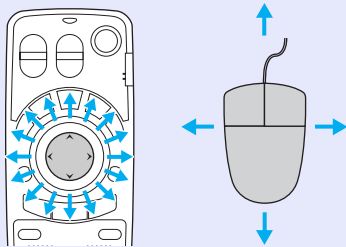

Left click

Press the [Enter (φ)] button.
If you press the [Enter (φ)] button twice in rapid succession, it has the effect of a double-click.

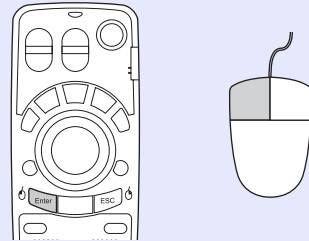

Right click

Press the [ESC (δ)] button.

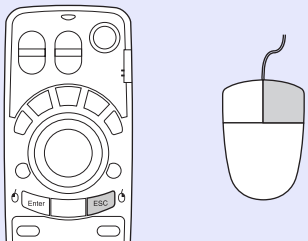

Drag and drop

When you hold down the [Enter (φ)] button for approximately 1.5 seconds, the button will light and drag and drop mode will be enabled. In this mode, you can carry out drag operations by tilting the [○] button.
Press the [Enter (φ)] button at the desired position to drop the items being dragged.

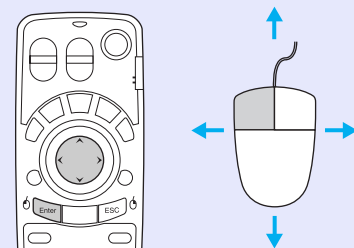

Drag and drop mode can also be enabled in the same way by pressing the [ESC (δ)] button for approximately 1.5 seconds. This operation allows right click dragging and dropping.



TIP

- *If the mouse button settings have been reversed at the computer, the operation of the remote control buttons will also be reversed.*
- *The wireless mouse function of the remote control cannot be used while the following functions are being used.*
 - *While a configuration menu is being displayed*
 - *While a help menu is being displayed*
 - *While the Effect function is being used*
 - *While a sub-screen has been set using the P in P function*
 - *While the E-Zoom function is being used*
 - *While a Quick Corner setting has been made*
 - *While a window is being displayed in real mode using the resize function*
 - *While the Preview function is being used*
 - *While a user's logo is being captured*



! CAUTION

When connecting the projector to other video sources, take the following precautions.

- Turn the power off for both the projector and the video source before connecting them. If the power for either device is on at the time of connection, damage may result.
- Check the shapes of the cable connectors and the device ports before making the connections. If you try to force a connector to fit a device port with a different shape or number of terminals, damage to the connector or port may result.
- Do not bind the power cable and the connecting cable together. If the power cable and the connecting cable are bound together, image interference or errors in operation may result.

Projecting Composite Video Images

Use a commercially-available RCA video cable to make the connection.

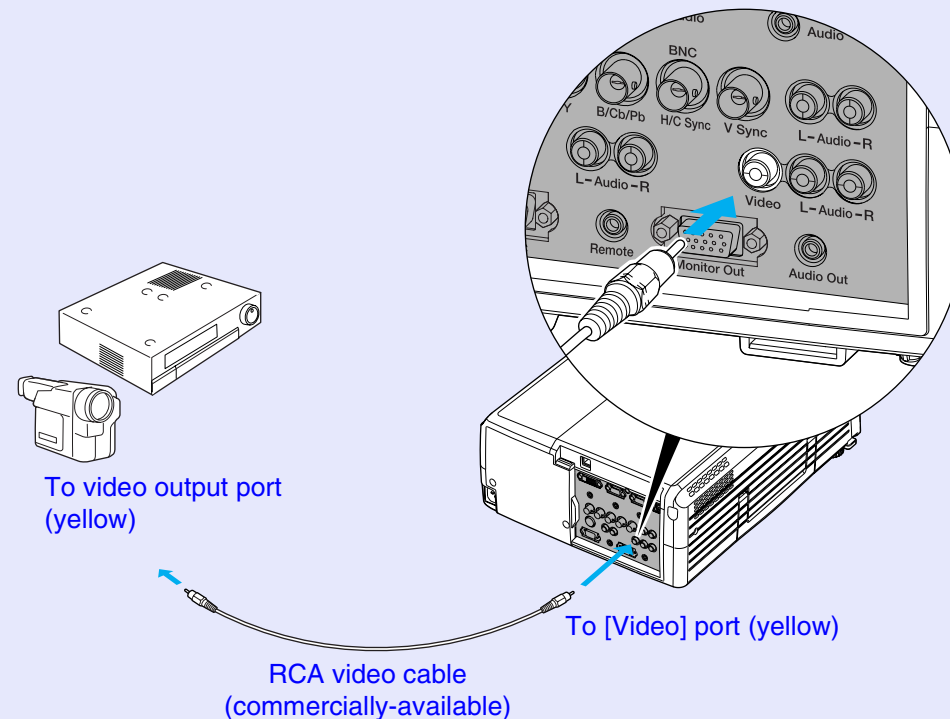

👉 TIP

If more than one external component is connected to the projector, press the [Video] button on the remote control after projection starts, or repeatedly press the [Video/BNC] button on the projector's control panel until "Video" is displayed on the projected image to select the signal to be projected. 📖 p.38

Projecting S-Video Images

Use a commercially-available [S-Video](#) cable to make the connections.

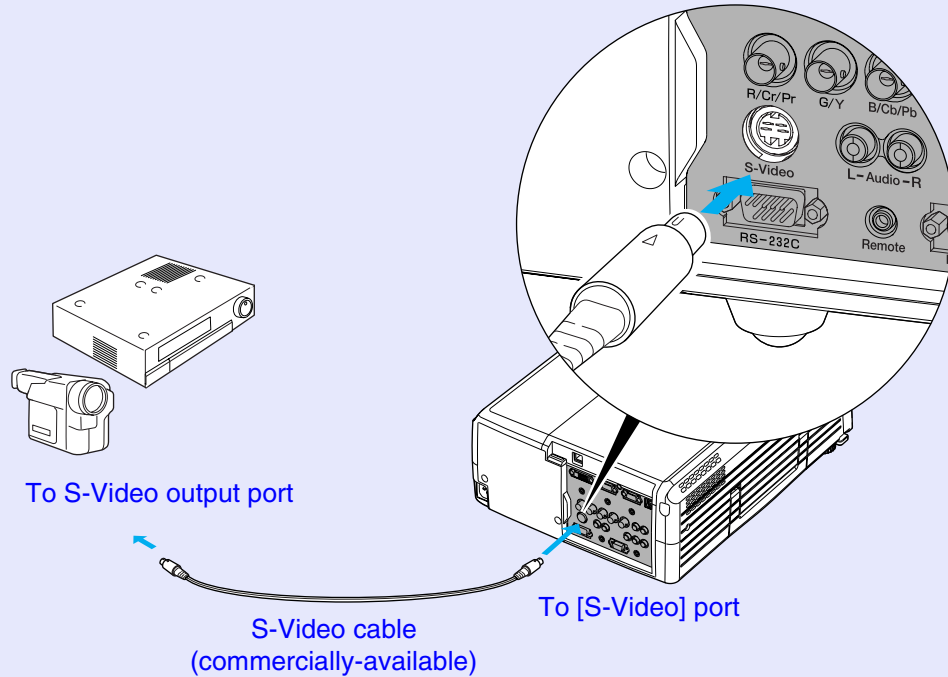

TIP

If more than one external component is connected to the projector, press the [S-Video] button on the remote control after projection starts, or repeatedly press the [Video/BNC] button on the projector's control panel until "S-Video" is displayed on the projected image to select the signal to be projected. [p.38](#)

Projecting Component Video Images

Use a commercially-available [component video](#) cable and three conversion adapters to make the connections.

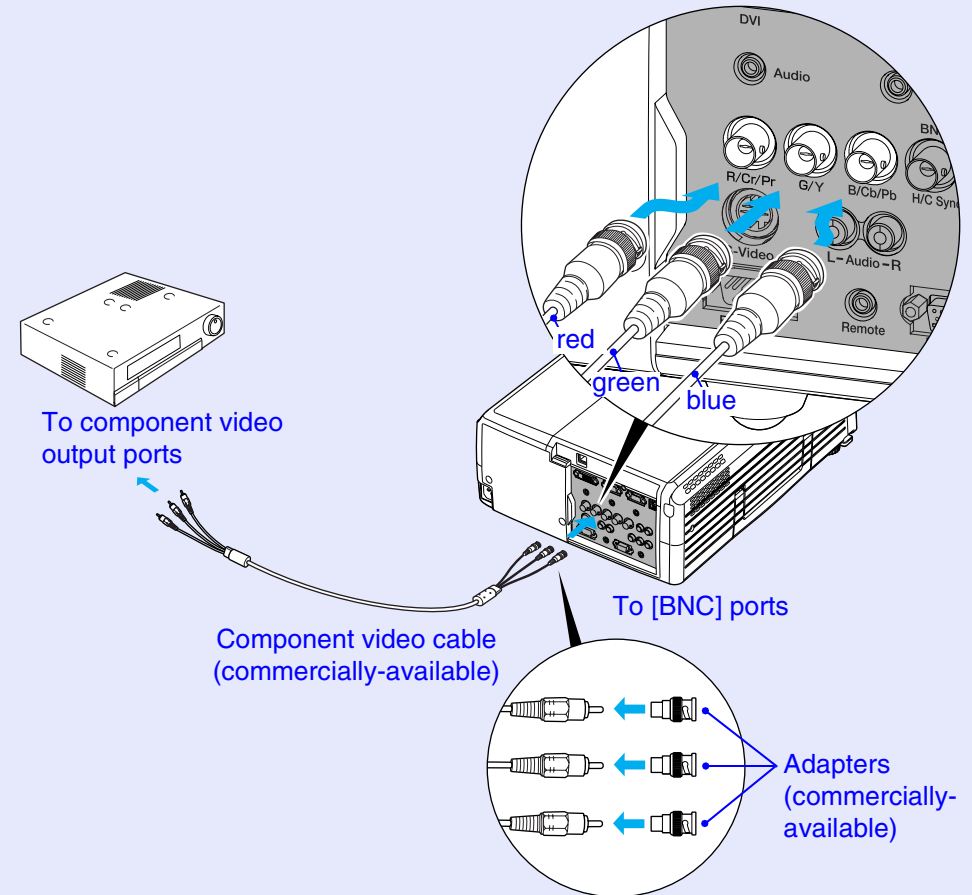



TIP

- After projection starts, change the "BNC Input" setting in the "Setting" menu to either "[YCbCr](#)" or "[YPbPr](#)" to match the signals from the video equipment. [p.81](#)
- If more than one external component is connected to the projector, press the [BNC] button on the remote control after projection starts, or repeatedly press the [Video/BNC] button on the projector's control panel until "BNC (YCbCr)" or "BNC (YPbPr)" is displayed on the projected image to select the signal to be projected. [p.38](#)

Projecting RGB Video Images

RGB video is used when projecting RGB signals from a video source other than a computer that is connected to the projector. Either of the following two connection methods can be used. Use whichever method is suitable for the video equipment's port.

■ If the RGB Output Port is a Mini D-Sub 15-pin Port

Use the accessory computer cable to make the connections.

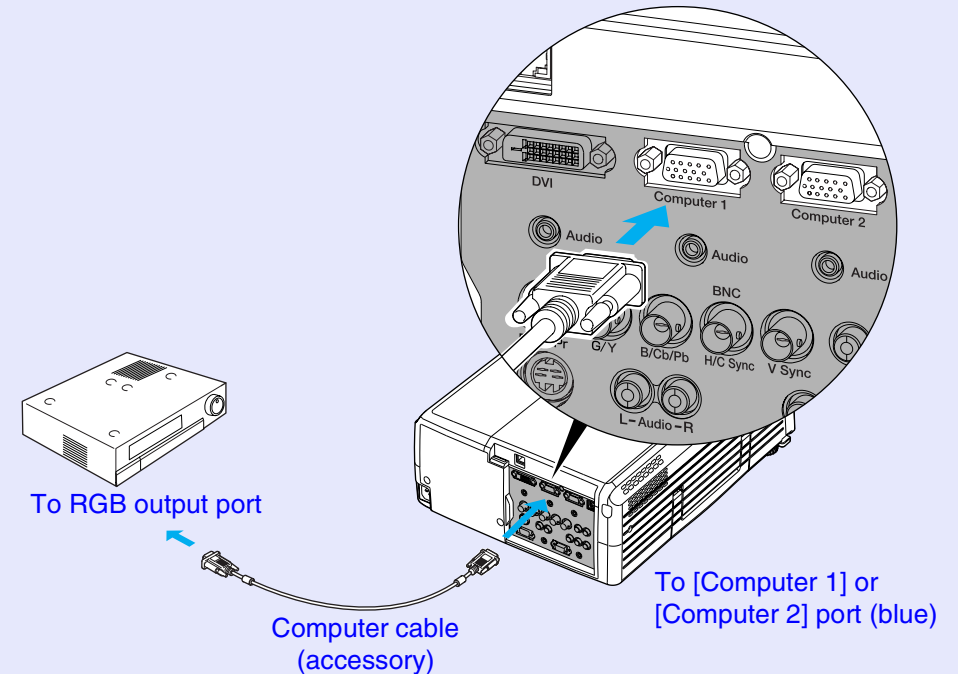

TIP

- After projection starts, change the "Computer1 Input" or "Computer2 Input" setting in the "Setting" menu to "RGB-Video". [p.80](#)
- If more than one external component is connected to the projector, press the [Comp1] or [Comp2] button on the remote control after projection starts, or repeatedly press the [Computer/DVI] button on the projector's control panel to select the signal to be projected. [p.38](#)



■ If the RGB Output Ports are the 3BNC Ports

Use a commercially-available RGB video cable to make the connections.

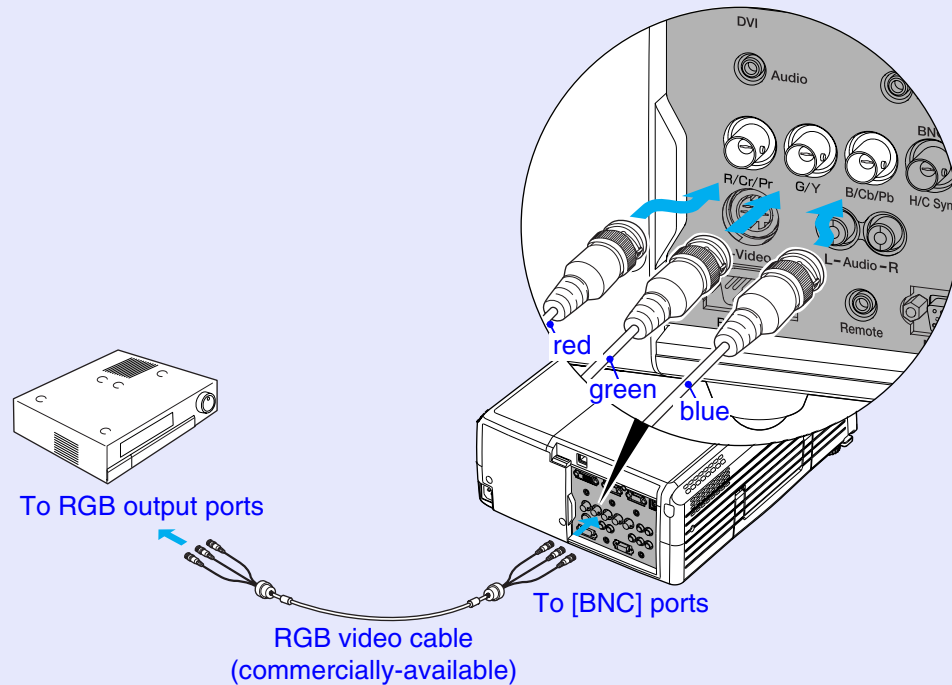
**TIP**

- After projection starts, change the "BNC Input" setting in the "Setting" menu to "RGB-Video". [☛ p.81](#)
- If more than one external component is connected to the projector, press the [BNC] button on the remote control after projection starts, or repeatedly press the [Video/BNC] button on the projector's control panel until "BNC (RGB-Video)" is displayed on the projected image to select the signal to be projected. [☛ p.38](#)

The projector has a built-in speaker with a maximum output of 7 W. You can output sound from the connected video equipment (such as a computer or video deck) through the projector's built-in speaker if the video equipment has an audio output port.

The [Audio] port to use is the port that is in the same box as the port being used to input the video signals.

The audio cable to use for the connection can be either of the following, depending on the shape of the [Audio] port.

- If the image signals are being input to the [DVI], [Computer 1] or [Computer 2] port, use the accessory audio cable.
- If the video signals are being input to the [BNC], [S-Video] or [Video] port, use a commercially-available RCA audio cable.



TIP

- *You can adjust the volume after projection has started.* [p.56](#)
- *If using a commercially-available 2RCA (L/R)/stereo mini-jack audio cable, use one that is marked as "No resistance".*

If the image signals are being input to the [Computer 1] port

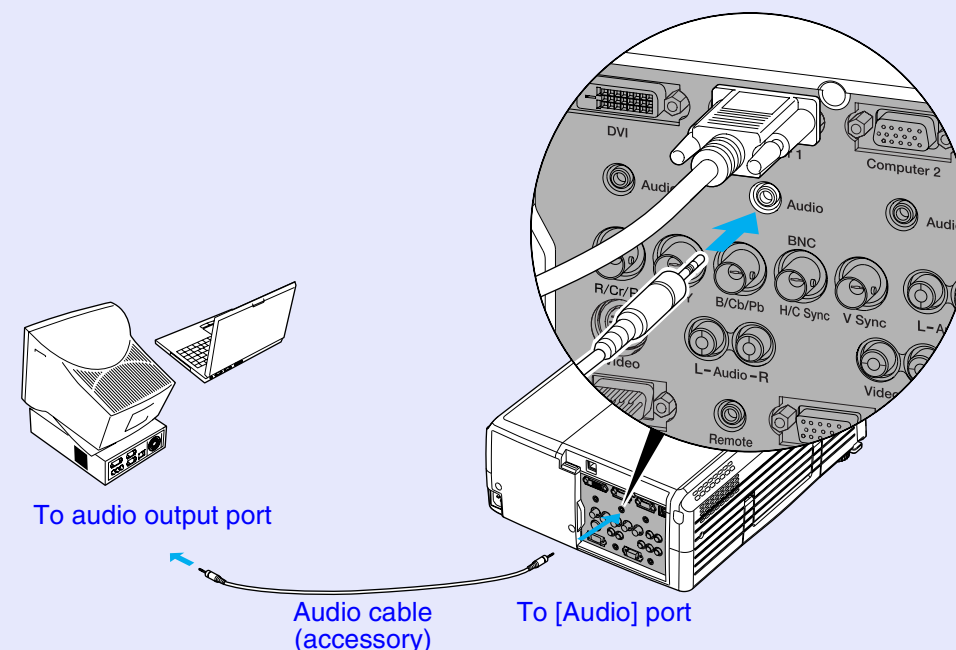

If the video signals are being input to the [Video] port

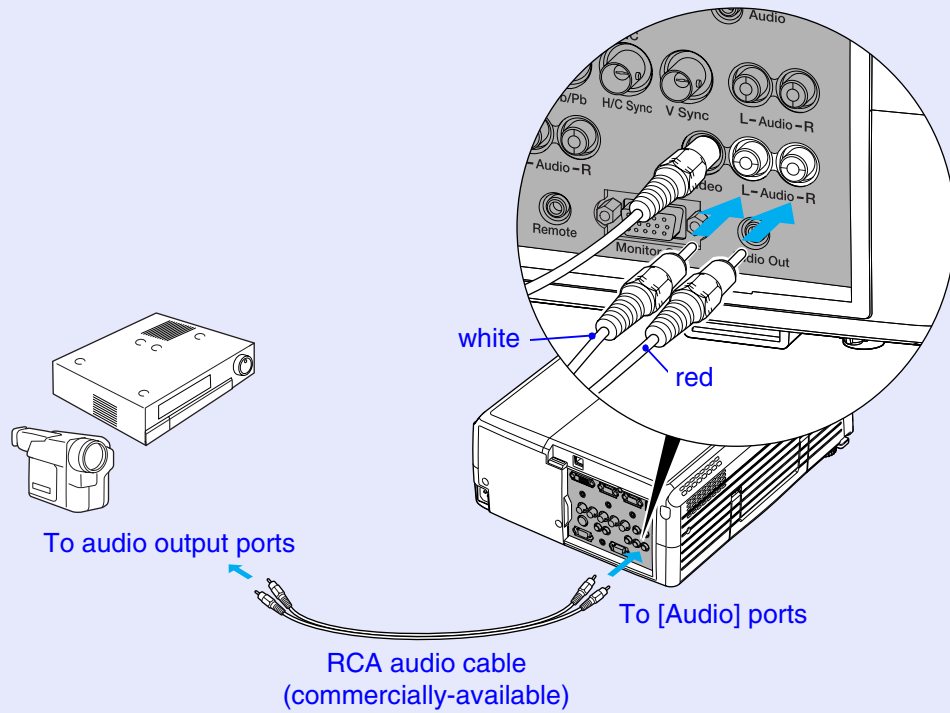

You can connect speakers with built-in amplifiers to the projector's [Audio Out] port in order to enjoy a fuller quality of sound.

Use a commercially-available audio cable with pin jack ⇔ stereo mini jack (3.5 mm) plugs or similar.

Use an audio cable with plugs that match the ports for the external audio equipment.

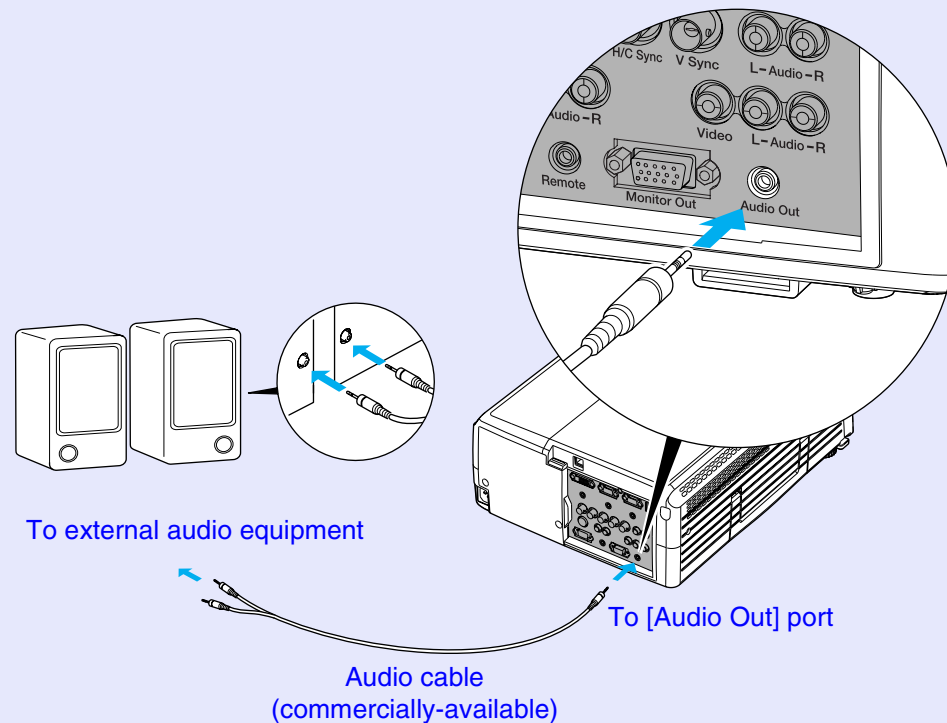
**TIP**

When a stereo mini-jack audio cable is inserted into the [Audio Out] port, the sound will be output to external speakers. No sound will be output from the projector's built-in speaker at this time.

If an external monitor is connected to the projector, you can operate the connected video equipment while viewing the images on the external monitor at the same time that they are being projected. This is useful when giving presentations. The signals being input from the video equipment can also be checked on the external monitor even when the projector itself is not projecting images (for example, when it is in standby mode) by using the standby monitor out function.

Connecting an External Monitor

Connect the external monitor using the cable that is provided with the monitor.

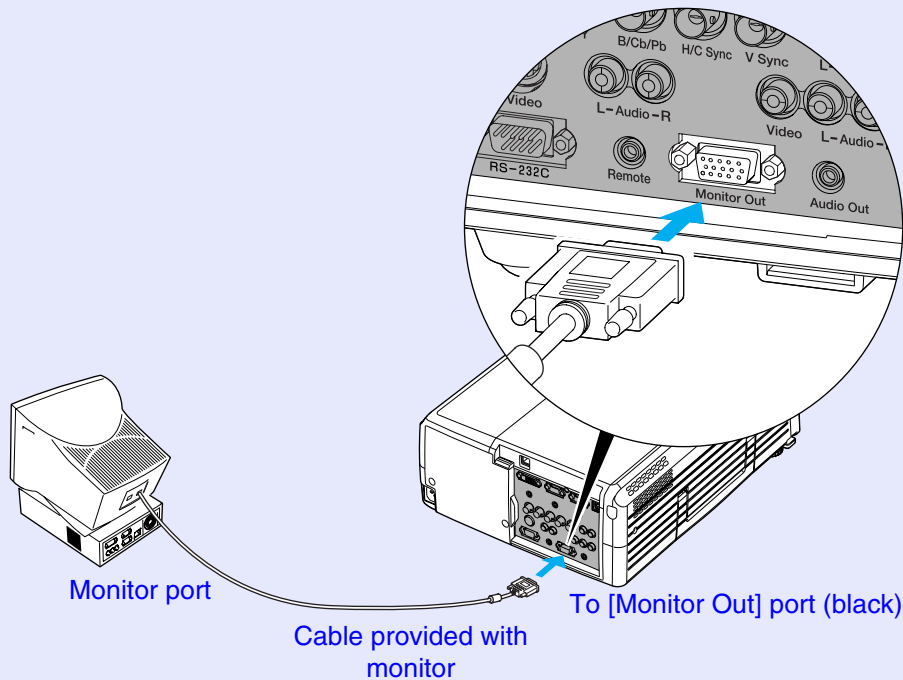

TIP

- **Setting gauges for functions such as keystone correction and configuration menu and help menu displays are also output to the external monitor.**
- **If the A/V mute function is operating and the projected images have been muted, the input signal images can still be displayed on the external monitor, and the [Source] buttons on the remote control and the projector's control panel can be used to change the signal source. To display the input signal images on the external monitor while the A/V mute function is active, change the "A/V Mute" setting in the "Setting" menu to "Black". If the "A/V Mute" setting is "Blue" or "Logo", the external monitor display will be the same as the image projected.**
- **When keystone correction is carried out, distortion will appear in the images displayed on the external monitor.**
- **The settings that have been made using the "Color Mode", "Color Adjustment", "Black Level", "White Level", "Rear Proj." and "Ceiling" menus will not appear in the images that are displayed on the external monitor.**

Checking Projected Images on an External Monitor While the Projector is at Standby (Standby Monitor Out)

"Standby mode" is the mode where the projector's power cable is connected to the projector but the [Power] button has not been pressed (the projection lamp is not turned on).

If the image signals from the connected video source are still being input even though the projector is in standby mode, the images can be displayed on an external monitor so that you can check the signals, and you can also change the video source. When the projector's power is turned on, the images that are being displayed on the external monitor will then be projected.

To use the standby monitor out function, change the "Standby Mode" setting in the "Advanced1" menu to "Network ON". [p.85](#)



TIP

Any sound being output from the projector's built-in speaker or from external speakers will be muted while standby monitor out is being used.

If the projector has been installed on a ceiling and then connected to a computer or other video source, you can then install the accessory cable cover. It covers the input and output ports and the cable connectors at the rear of the projector to provide greater protection.

■ Installation

Insert the cover tabs into the three cable cover mounting holes in the base of the projector, and then push the cable cover in until it clicks into place.

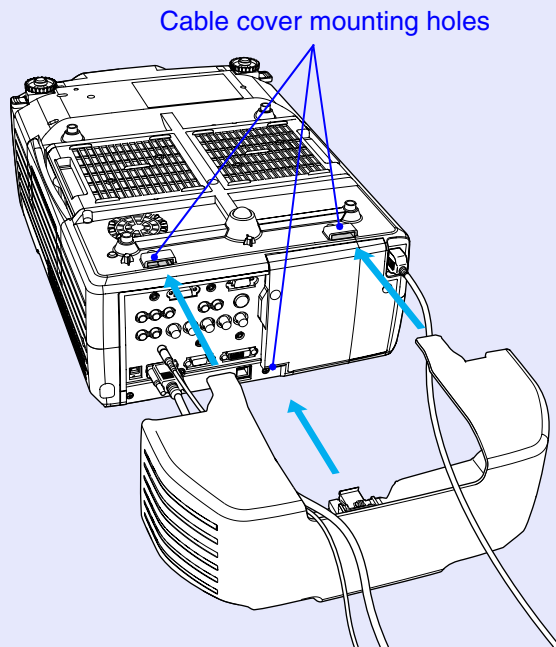

■ Removal

Remove the cable cover when replacing the lamp and when connecting and disconnecting any of the cables.

Pull the cable cover lever in the [OPEN ➔] direction to remove the cable cover.

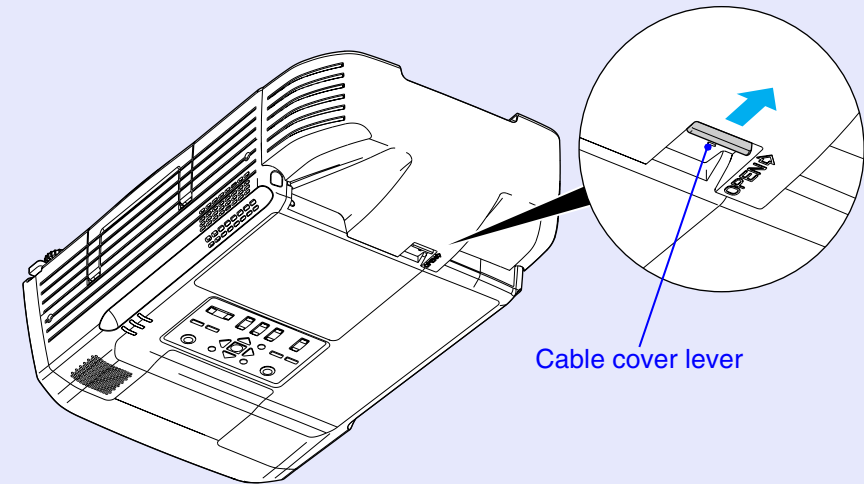



Basic Operations

This chapter describes basic operations such as turning projection on and off and adjusting the projected images.

Turning the Projector On.....	36	• Correcting Distortion in the Projection Area (Keystone Correction).....	47
• Connecting the Power Cable	36	• Correcting Keystone Distortion so that the Projection Area Fits the Screen Exactly (Quick Corner)	47
• Turning the Power On and Projecting Images	37	• Correcting Vertical Keystone Distortion (V-Keystone).....	49
• Selecting an Image Source While Viewing Projected Images (Preview Function).....	39	• Correcting the Height of the Projection Area After Vertical Keystone Correction (Height Correction)	50
Turning the Projector Off.....	41	Adjusting the Image Quality.....	52
Adjusting the Screen Image	43	• Adjusting Computer Images	52
• Adjusting the Image Size (Zoom Function).....	43	• Automatic Setup	52
• Focusing the Screen Images (Focus Adjustment).....	44	• Adjusting the Tracking	53
• Adjusting the Image Angle.....	44	• Adjusting the Sync	54
• If the projection area is too low or too high for the screen.....	44	• Selecting the Projection Quality (Colour Mode Selection)	55
• When projecting from the side of the screen	45	Adjusting the Volume.....	56
• Adjusting the Vertical Position of the Projection Area (Lens Shift)	45		
• Adjusting the Front Adjustable Feet.....	46		

Turn the power on to start projecting images.



CAUTION

Be sure to read the Safety Instructions/World-Wide Warranty Terms before projecting images.

Connecting the Power Cable

PROCEDURE

1 Check that the power is turned off for the projector and all components connected to the projector.

2 Connect the computer or other video source to the projector. [p.17](#), [p.25](#)

3 **Remove the lens cover.**
Hook your finger under the top of the lens cover and pull to remove it.

4 **Connect the accessory power cable to the projector.**

Check that the power connector is facing the same way as the power inlet on the projector, and then insert the power cable connector securely into the projector.

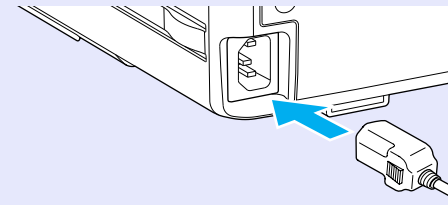

5 **Connect the other end of the power cable to an earthed electrical outlet.**

Wait until the  indicator lights orange.

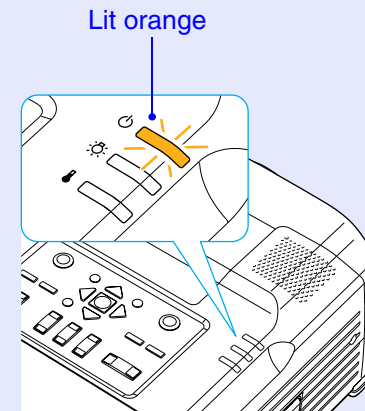

Turning the Power On and Projecting Images

PROCEDURE

- 1 Check that the  indicator has stopped flashing and is lit orange.

- 2 If using the remote control, set the [R/C] switch on the remote control to "ON".

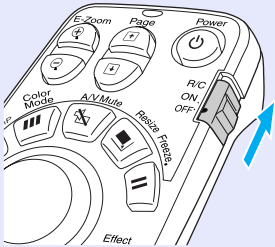

- 3 Turn the power on for all equipment connected to the projector.

For a video source, press the [Play] button at the video source to start playback if necessary.



- 4 Press the [Power] button on either the remote control or the projector's control panel to turn the power on for the projector.

The  indicator flashes green. After a short period it stops flashing and lights steadily, and projection starts.

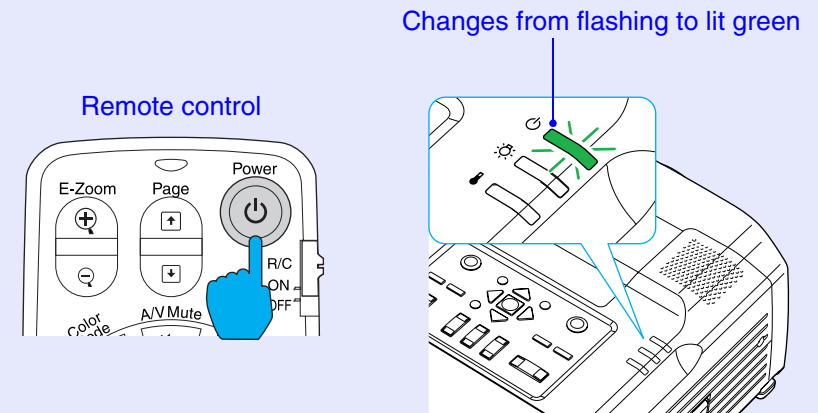
Wait until the  indicator lights green (it normally takes about 40 seconds to change).



TIP

- *The remote control and projector's control panel buttons will not function while the  indicator is flashing green.*
- *Depending on the configuration menu settings, the message "No Signal." may appear. See "Setting" - "No-Signal Msg."  p.80*



5 If more than one external device is connected to the projector, use the remote control or projector control panel buttons to select the image source to be projected while referring to the following table.

You can also use the preview function to select the signal source. p.39

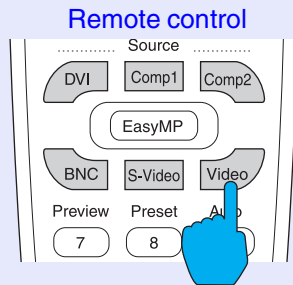

Port	Button to press		On-screen display
	Remote control	Projector	
DVI	[DVI]		DVI
Computer 1	[Comp1] ^{*1}	The image source changes each time [Computer/DVI] is pressed. ^{*2}	Computer1 (Analog-RGB) ^{*3}
Computer 2	[Comp2] ^{*1}		Computer1 (RGB-Video) ^{*3}
			Computer2 (Analog-RGB) ^{*4}
			Computer2 (RGB-Video) ^{*4}
BNC	[BNC] ^{*1}	The image source changes each time [Video/BNC] is pressed. ^{*5}	BNC(Analog-RGB) ^{*6}
			BNC(RGB-Video) ^{*6}
			BNC(YCbCr) ^{*6}
			BNC(YPbPr) ^{*6}
S-Video	[S-Video]		S-Video
Video	[Video]	Video	

- *1 When these buttons are pressed once, the signal name that is currently set using the configuration menus appears on the screen. You can change the signal setting by repeatedly pressing the button while the signal name is displayed. The result of this switching will also be applied to the "Computer1 Input", "Computer2 Input" or "BNC Input" setting in the "Setting" menu.
- *2 The input signal will not change to the next signal source unless the [Computer/DVI] button is pressed while the current signal name is still being displayed on the screen.
If an input signal from either the [DVI], [Computer 1] or [Computer 2] port is currently being projected, the name of this current input signal will be displayed on the screen when the [Computer/DVI] button is pressed once.
- *3 The item selected using the "Computer1 Input" command in the "Setting" menu will appear. You can change the setting by pressing the [Comp1] button on the remote control.
- *4 The item selected using the "Computer2 Input" command in the "Setting" menu will appear. You can change the source by pressing the [Comp2] button on the remote control.
- *5 The input signal will not change to the next signal unless the [Video/BNC] button is pressed while the current signal name is still being displayed on the screen.
If an input signal from either of the [BNC], [S-Video] or [Video] ports is currently being displayed, the name of this current input signal will be displayed on the screen when the [Video/BNC] button is pressed once.
- *6 The item selected using the "BNC Input" command in the "Setting" menu will appear. You can change the source to the next source in order by pressing the [BNC] button on the remote control.

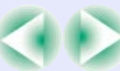



TIP

- If only one signal source has been connected, the signals from that source will be projected without needing to press one of the [Source] buttons.
- If the "No Signal." message does not disappear, check the connections again.
- If a laptop computer or a computer with an LCD screen has been connected to the projector, the images may not be projected straight away. After starting projection, check that the computer has been set up to output signals externally.
The following table shows examples of how to toggle output settings. For details, refer to the section of the documentation provided with your computer under a heading such as "External output", "Connecting an external monitor" or similar.

NEC	Panasonic	Toshiba	IBM	Sony	Fujitsu	Macintosh
[Fn]+[F3]	[Fn]+[F3]	[Fn]+[F5]	[Fn]+[F7]	[Fn]+[F7]	[Fn]+[F10]	After startup, change the Control Panel adjustment so that mirroring is active.

- If the same still picture is projected for a long period of time, the projected image may become burned in on the computer screen. You should avoid leaving the same image displayed for long periods.

Selecting an Image Source While Viewing Projected Images (Preview Function)

The preview function lets you project the images from the currently-selected image source and view them in a preview screen while selecting the signal source.

Use the remote control to carry out all preview function operations.

PROCEDURE

- 1 **Press the [Preview] button on the remote control.**
After a short while, a preview screen such as the one shown in the illustration below will appear on the screen.
When the preview screen is being displayed, the frames for ports that have no image signal being input or which have a signal being input that is not supported will be solid blue. Press the [Source] buttons on the remote control to select the image source to be projected in order to change the image.

Active window

Shows the images that are currently being projected.

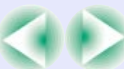
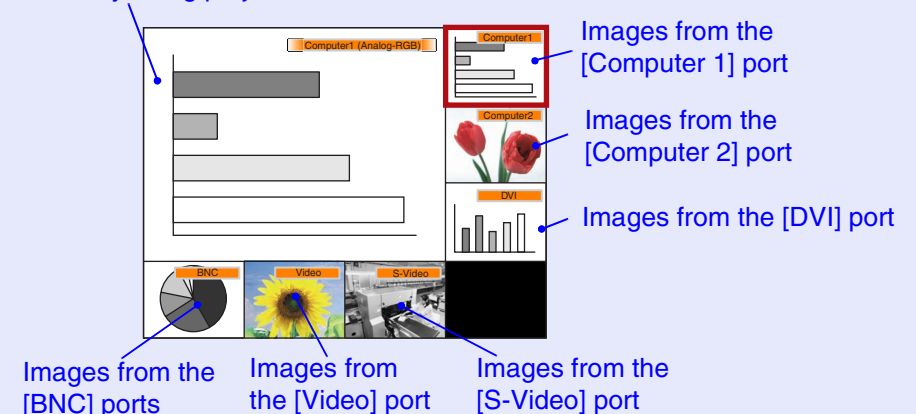

2 Tilt the [○] button to select the images to be projected.

Move the red box until the desired image is selected.

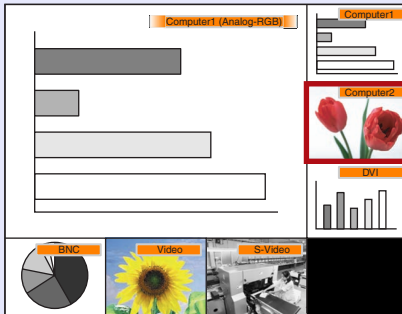

TIP

- You can hear the sound for the images in the active window while the preview window is being displayed.
- Images other than the image in the active window will be projected as still images.
- If you press the [Preview] button while E-Zoom function is active or real display is being used, these functions will be cancelled and the preview screen will be displayed. If you cancel the preview function without changing the input source, the projected images will return to the state they were at before the preview function was activated.

3 Press the [Enter] button.

The selected images are then projected in the active window. If you press the [Enter] button once more, the preview function is cancelled and the images in the active window are projected.

To return to the images that were being projected before the preview function was activated, press the [ESC] or [Preview] button.



Follow the procedure below to turn the projector off.

PROCEDURE

- 1 Turn the power off for the signal sources that are connected to the projector.**

Check that the power for all connected components has been turned off.

- 2 Press the [Power] button on either the remote control or the projector's control panel.**

Remote control

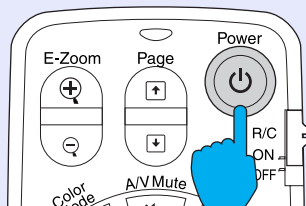

The following confirmation message will appear.

Power OFF?

Yes : Press  button

No : Press any other button

If you do not want to turn the power off, press a button other than any of the following:

- At the remote control: [Power], [◻], [◻], [⊙], [Num], [ID]
- At the control panel : [Power]

If you do not press any button, the message will disappear automatically after seven seconds. (The power will not turn off at this time.)



TIP

If the message "The projector is overheated. Clean or replace the air filter and lower the room temperature." appears on the screen, press the [Enter] button on the remote control or the [Auto/Enter] button on the projector's control panel to turn the power off and then clean the air filters. [p.122](#)

3

- 3 Press the [Power] button on either the remote control or the projector's control panel once more.**

The lamp will switch off. The  indicator will flash orange and [cool-down](#) will start.

The cool-down period lasts for about 30 seconds.

When cool-down is complete, the  indicator lights orange.

Stops flashing and lights orange

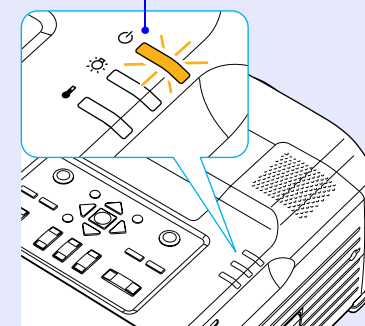

TIP

The remote control and projector's control panel buttons cannot be operated while the  indicator is flashing orange. Wait until it lights constantly.

- 4** If not using the projector for a long period, unplug the power cable from the electrical outlet.

CAUTION

Do not disconnect the power cable from the electrical outlet while the  indicator is flashing orange, otherwise operating problems may result.

- 5** Set the [R/C] switch on the remote control to "OFF".

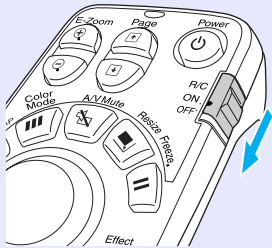

TIP

If you leave the [R/C] switch on the remote control at "ON", it will consume battery power. When not using the remote control, set the [R/C] switch to "OFF".

- 6** Attach the lens cover.

Attach the lens cover to the lens when not using the projector, in order to stop the lens from getting dusty or dirty.

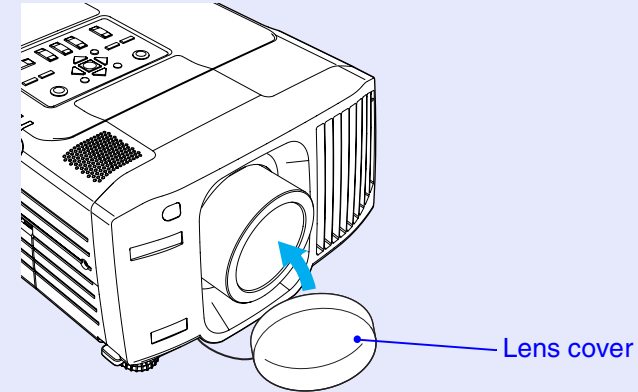

You can correct and adjust the screen images in order to obtain the best possible pictures.

Adjusting the Image Size (Zoom Function)

The size of the projected images is basically determined by the distance from the projector to the screen. [p.16](#)

The following procedures explain how to adjust the screen images once the projector itself has been set up.



TIP

- *Do not use electronic zoom adjustment (using button operations) if the projector is fitted with an optional rear projection wide lens. Refer to the documentation for the rear projection wide lens for further details.*
- *The E-Zoom function can also be used to enlarge parts of the images.* [p.59](#)

PROCEDURE

Press the [Zoom] buttons on either the remote control or the projector's control panel to adjust the images.

If a standard lens is fitted, the images can be enlarged in this way to 1.35 times the normal size.

If you press the [5] button on the remote control or the [W] button on the projector's control panel, the images are increased in size.

Remote control

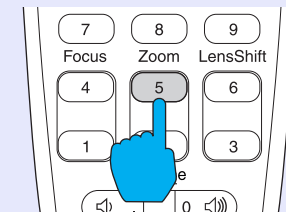
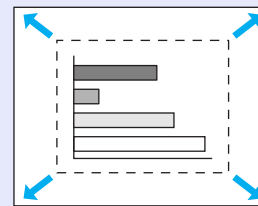

If you press the [2] button on the remote control or the [T] button on the projector's control panel, the images are reduced in size.

Remote control

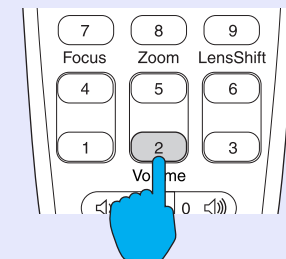
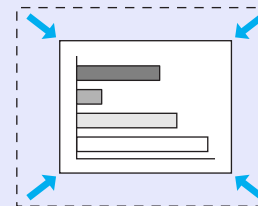

If you would like to enlarge the images further, move the projector further away from the screen. [p.16](#)

Focusing the Screen Images (Focus Adjustment)



TIP

- Do not use electronic focus adjustment (using button operations) if the projector is fitted with an optional rear projection wide lens. Refer to the documentation for the rear projection wide lens for further details.
- If the surface of the lens is dirty or misted over as a result of condensation, it may not be possible to adjust the focus correctly. If this happens, clean or de-mist the lens. [p.115](#), [p.122](#)

PROCEDURE

Press the [Focus] buttons on either the remote control or the projector's control panel.

Remote control

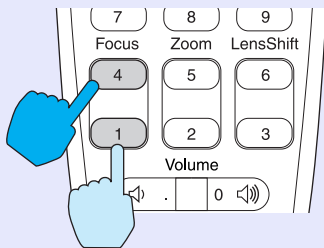

Adjusting the Image Angle

If the projector is set up so that it is at a horizontal or vertical angle to the screen, adjust as follows.

■ If the projection area is too low or too high for the screen

- You can use the lens shift function to move the lens vertically in order to adjust the vertical position of the lens. This can be used at times such as if the screen is in a high position or the projector is suspended from a high ceiling. [p.45](#)

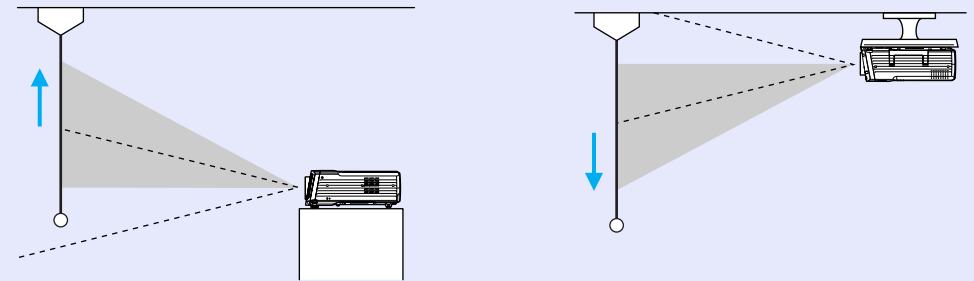

- If correct adjustment cannot be obtained using the lens shift function, extend the front adjustable feet to tilt the projector. [p.46](#)
When the projector is tilted, keystone distortion may appear in the projected images. If this happens, you can correct this keystone distortion. [p.47](#)

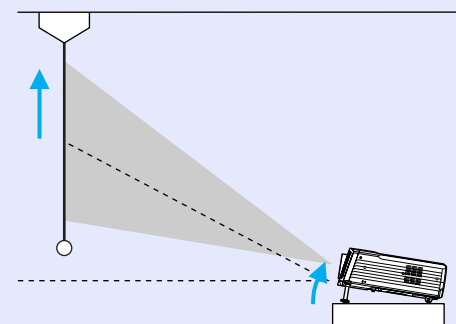

When projecting from the side of the screen

If the projector cannot be set up directly in front of the screen, you can project images at a horizontal angle to the screen. If keystone distortion appears in the images, you can use the projector's Quick Corner function to correct this keystone distortion. [p.47](#)

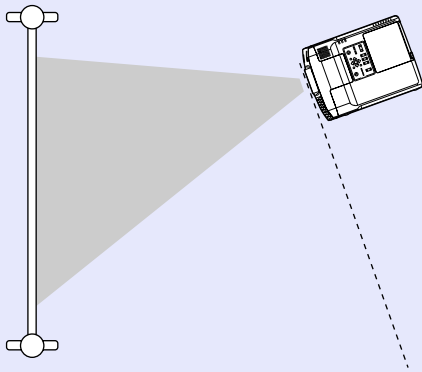

PROCEDURE

Press the [Lens Shift] buttons on either the remote control or the projector's control panel.

If you press the [6] button on the remote control or the [△] button on the projector's control panel, the projection area will move up.

If you press the [3] button on the remote control or the [▽] button on the projector's control panel, the projection area will move down.

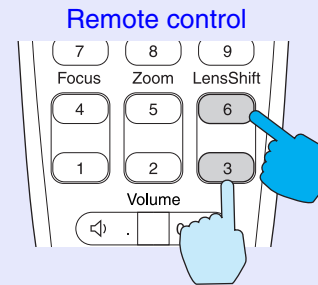

TIP

Do not use electronic lens shift adjustment (using button operations) if the projector is fitted with an optional rear projection wide lens. Refer to the documentation for the rear projection wide lens for further details.

Adjusting the Vertical Position of the Projection Area (Lens Shift)

The vertical position of the projection area can be adjusted by moving the lens up or down.

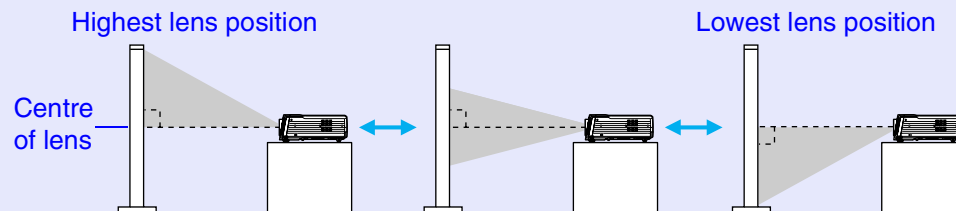

Adjusting the Front Adjustable Feet

You can extend or retract the front adjustable feet to tilt the projector to adjust the upward projection angle within a maximum range of 9°.

TIP

When using the front adjustable feet to adjust the angle of the projector, it may cause keystone distortion to appear in the images. If this happens, you can use the keystone correction function to correct keystone distortion. [p.47](#)

PROCEDURE

While pulling the two foot adjust levers at either side, lift up the front of the projector so that the front adjustable feet can extend.

Extend the front adjustable feet until the desired angle is obtained, and then release the foot adjust levers.

To retract the front adjustable feet, gently push down on the projector while pulling the foot adjust levers.

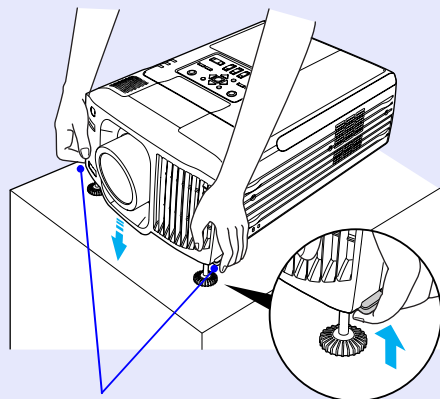

Foot adjust levers (side)

TIP

If the projector is tilted horizontally, the heights of the front adjustable feet at left and right will not match each other. In this case, you can either readjust the height using the foot adjust levers, or turn the bases of the front adjustable feet to adjust the angle until the projector is horizontal.

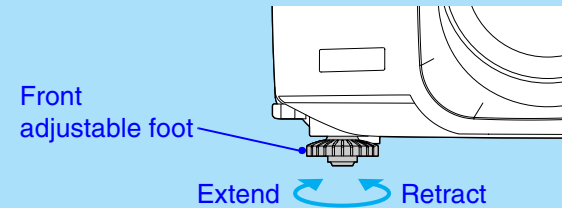

Correcting Distortion in the Projection Area (Keystone Correction)

The projector is equipped with the following two functions for correcting keystone distortion. Use whichever function is effective for correcting the distortion.

- Quick Corner:

This correction function is used when both horizontal and vertical keystone distortion occurs in the projection area to adjust the projection area so that it fits the screen exactly.

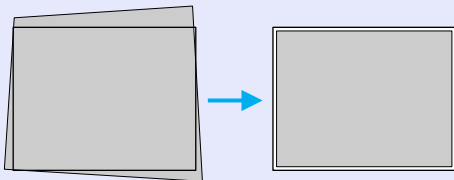

- Vertical keystone:

This correction function is used when vertical keystone distortion occurs in the projection area.

The keystone correction function lets you easily correct keystone distortion that has occurred after moving the projector, simply by using buttons on the projector's control panel. [p.49](#)

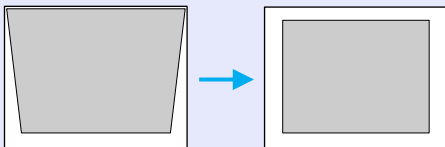

TIP

- *The "Quick Corner" and "V-Keystone" correction functions cannot both be used together to correct keystone distortion. If you use one function to correct keystone distortion, any correction that has been applied using the other function will be cancelled.*
- *The larger the angle of tilt, the poorer the focus of the contours in the projected images will become.*
- *If a large amount of keystone correction is applied, fine details such as text characters and lines may go out of focus.*
- *Keystone corrections that have been applied using the keystone correction functions are memorised even when the projector's power is turned off. If you have changed the projection position or angle, you will need to repeat the correction procedure.*

Correcting Keystone Distortion so that the Projection Area Fits the Screen Exactly (Quick Corner)

The Quick Corner function is operated using the configuration menu.



TIP

If the projector has been tilted during setup to within a range of 45° vertically or 40° horizontally, you can use the Quick Corner function to correct keystone distortion.

However, the applicable angles will become smaller under the following conditions.

- *If the projector has been tilted both horizontally and vertically*
- *If an optional projection lens has been fitted*
- *If the lens position has been shifted or zoom has been set to "W"*



PROCEDURE

- 1 Press the [Menu] button on either the remote control or the projector's control panel, and then select "Quick Corner" from the "Keystone" sub-menu of the "Setting" menu.

The Quick Corner correction screen will be displayed.

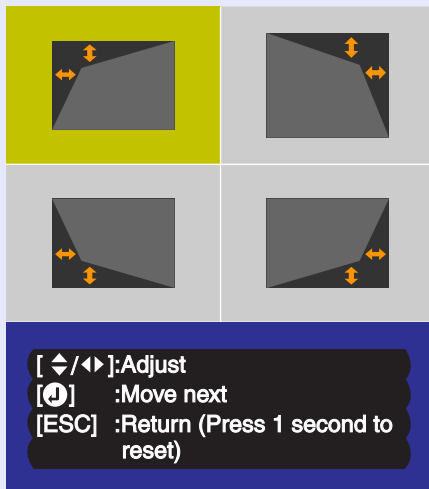

- 2 Press the [Enter] button on the remote control or the [Auto/Enter] button on the projector's control panel to select the correction angle in the screen.

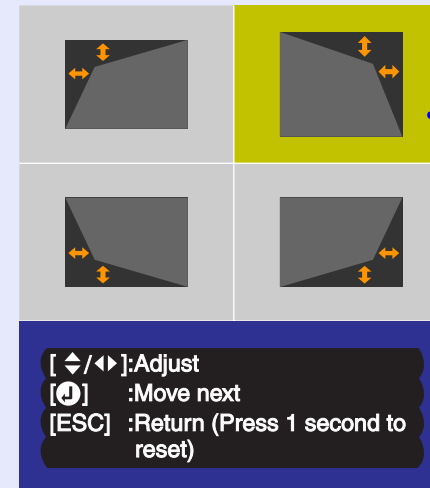

The selected angle will appear yellow.

- 3 Tilt the [

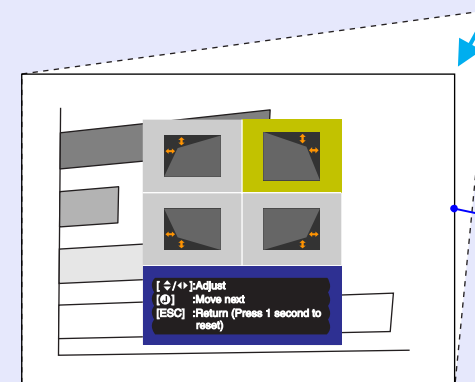

Screen

**TIP**

- If you hold down the [Shift] button on the projector's control panel while pressing the [Sync +], [Sync -], [Tracking +] and [Tracking -] buttons, the units by which the adjustment value changes will become greater, so that correction can be carried out more quickly.
- If you press down the [ESC] button on either the remote control or the projector's control panel for one second while the Quick Corner correction screen is displayed, the correction results will be restored to their default values.
- If the message "Cannot move anymore." appears on the screen while using the Quick Corner function, it means that the limit for correction has been reached. Check the following two points.
 - Is the projection distance appropriate for the size of the projection screen? [p.16](#)
 - Is the projector tilted too much? [p.47](#)
- If the input signal is interrupted or a signal that is not supported is input while using the Quick Corner function, the correction value at that point will be recorded and then the Quick Corner function will then be exited.
- If the Quick Corner correction screen is displayed while the E-Zoom function is being used, E-Zoom function will be cancelled.

4

When the correct is complete, press the [Menu] button on either the remote control or the projector's control panel.

Correcting Vertical Keystone Distortion (V-Keystone)

Vertical keystone correction can be carried out using either the projector's control panel or the configuration menus. This procedure explains how to use the projector's control panel to correct keystone distortion.

For adjustment using the configuration menus:

See "Setting" - "Keystone" - "V-Keystone" [p.80](#)

**TIP**

If the projector has been tilted during setup to within a range of 45° vertically, you can use the vertical keystone function to correct keystone distortion.

However, the applicable angles will become smaller under the following conditions.

- If an optional projection lens has been fitted
- If the lens position has been shifted or zoom has been set to "W"

PROCEDURE

If the bottom of the image is elongated

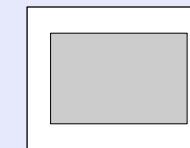
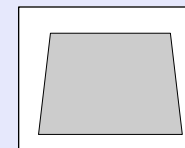

If the top of the image is elongated

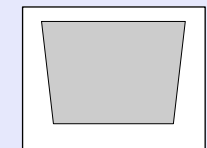

Projector

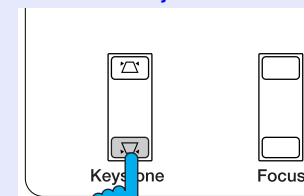

Keystone

Focus

Projector

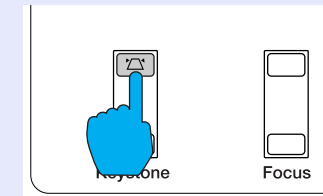

Keystone

Focus

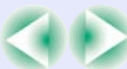



TIP

- When vertical keystone correction is carried out, the projected images will become smaller. Use the [Zoom] button to adjust the size of the images. [p.43](#)
- If the images become uneven in appearance after vertical keystone correction is carried out, decrease the sharpness setting. [p.73, p.76](#)
- If the value displayed in the gauge on the screen stops changing when vertical keystone correction is being carried out, it indicates that the limit for vertical keystone correction has been exceeded. Check that the projector has not been set up at an angle which exceeds the proper limit.
- If the V-Keystone function is used while any of the following functions are in use, the function in use will be cancelled.
 - E-Zoom · Real display · Freeze · A/V Mute

Correcting the Height of the Projection Area After Vertical Keystone Correction (Height Correction)

When vertical keystone correction is carried out, the height of the projected images will become shorter. Use the height correction function to adjust the height of the projection area.

Adjustments using the height correction function are carried out using the configuration menus.

PROCEDURE

1

Press the [Menu] button on either the remote control or the projector's control panel. Then select "Height" from the "Keystone" sub-menu of the "Setting" menu.

The height correction screen will be displayed. See "Using the Configuration Menus" for details on this operation. [p.90](#)

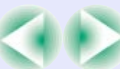
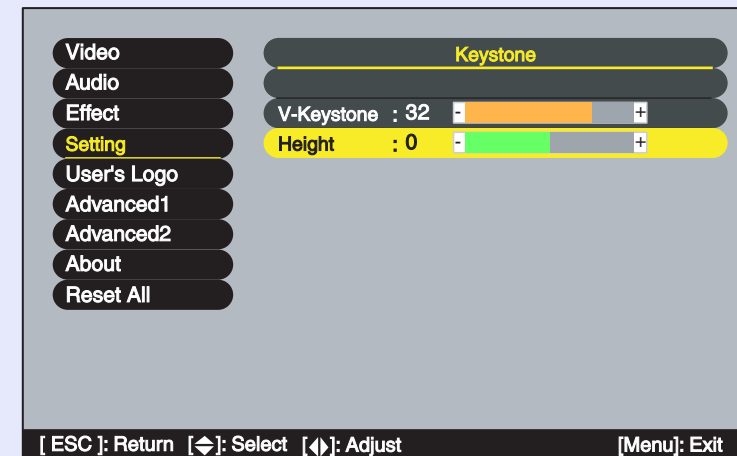

- 2 Tilt the [○] button on the remote control to the left or right, or press the [Tracking +] or [Tracking -] buttons on the projector's control panel to correct the height while viewing the projected images.

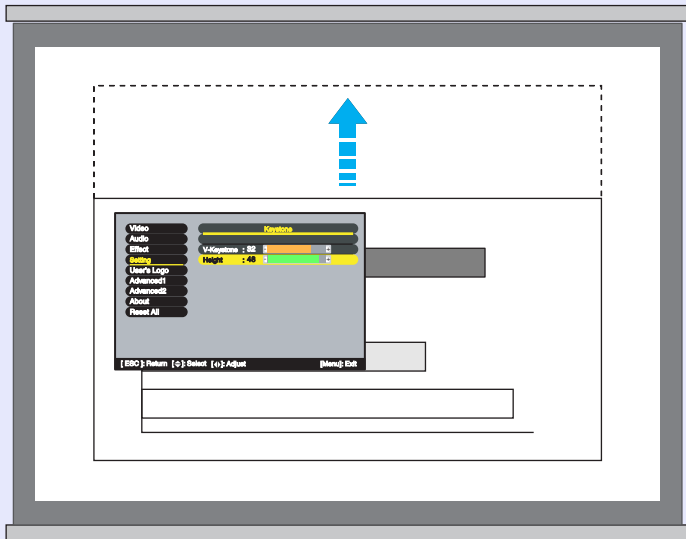

- 3 When the adjustment is complete, press the [Menu] button on either the remote control or the projector's control panel to close the configuration menu.



The quality of the projected images can be adjusted as follows.

Adjusting Computer Images

Automatic Setup

Automatic setup detects analogue RGB signals coming from a connected computer, and automatically adjusts these signals so that the optimum images can be obtained.

Automatic setup involves adjustment of the following three items:

[Tracking](#), Position and [Sync](#).



TIP

- If "Auto Setup" in the "Advanced2" menu is set to "OFF" (the default setting for this command is "ON"), automatic setup is not carried out. If you press the [Auto] button on the remote control or the [Auto/Enter] button on the projector's control panel while computer images (analogue RGB signals) are being projected, adjustment will then be carried out.

Remote control

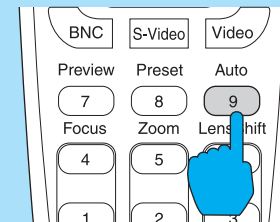

- If you press the [Auto] button on the remote control or the [Auto/Enter] button on the projector's control panel while the E-Zoom function or Freeze function is active, the active function will be cancelled and then the adjustment will be carried out.
- Sometimes the signals may not be adjusted correctly depending on the type of signals being output by the computer. In such cases, use the "Tracking", "Position" and "Sync." menu commands to make the adjustments manually. [p.53](#), [p.54](#), [p.73](#)
- Automatic setup is not carried out while the preview function is being used.

Adjusting the Tracking

If vertical stripes appear in the projected images, and this cannot be fixed using automatic setup, you will need to adjust the [tracking](#) manually using the following procedure.

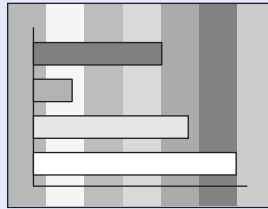

PROCEDURE

Tracking adjustment can be carried out using either the projector's control panel or the configuration menus. This procedure explains how to use the projector's control panel to adjust the tracking.

For adjustment using the configuration menus:
See "Video" - "Tracking" [p.73](#)

Press the following buttons to adjust the tracking value until the vertical stripes disappear from the projected images.

Press the [Tracking +] button on the projector's control panel.

The tracking value increases each time the button is pressed.

Projector

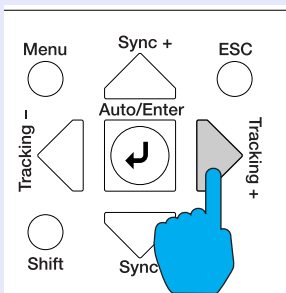

Press the [Tracking -] button on the projector's control panel.

The tracking value decreases each time the button is pressed.

Projector

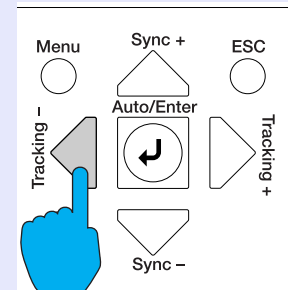

TIP

The images will flash when continuous tracking adjustment is carried out, but this is normal.

Adjusting the Sync

If flickering, fuzziness or interference appear in images that are input from the computer, and this cannot be fixed using automatic setup, you will need to adjust the [sync](#) manually using the following procedure.

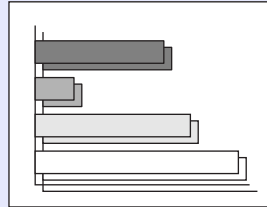

PROCEDURE

Sync adjustment can be carried out using either the projector's control panel or the configuration menus. This procedure explains how to use the projector's control panel to adjust the sync. For adjustment using the configuration menus: See "Video" - "Sync." [p.73](#)

Press the following buttons to adjust the sync value until the flickering, fuzziness or interference disappears from the projected images.

Press the [Sync +] button on the projector's control panel.

The sync value increases each time the button is pressed.

Projector

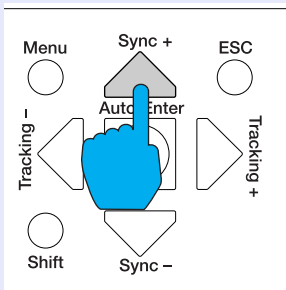

Press the [Sync -] button on the projector's control panel.

The sync value decreases each time the button is pressed.

Projector

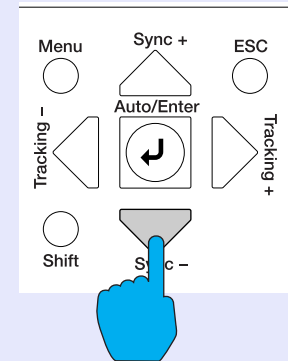

TIP

- *If you adjust the sync without adjusting the tracking first, it will not be possible to get the best adjustment results. Incorrect tracking adjustment may not be noticeable with some types of image. However, images with lots of lines and shading will tend to show incorrect tracking adjustments more clearly, so be sure to check the tracking adjustment first.*
- *It may also be possible to fix flickering and fuzziness by adjusting the brightness, [contrast](#), sharpness and keystone correction settings.*

Selecting the Projection Quality (Colour Mode Selection)

The following five preset colour modes are available for use depending on the characteristics of the images that are being projected. You can easily obtain the optimum image quality simply by selecting the colour mode that corresponds to the projected images. The brightness of the images will vary depending on which colour mode is selected.

Mode	Application
Dynamic	Images are modulated and made fresher to emphasise brightness.
Presentation	Brightness is emphasised. For presentations in bright rooms.
Theatre	Movie images are optimised using natural tints.
Living Room	Brightness is emphasised. Ideal for playing video games in bright rooms.
sRGB ▶▶	Images conform to the sRGB colour standard. If the connected source has a sRGB mode, set both the projector and the connected signal source to sRGB.

PROCEDURE

Selecting the colour mode can be carried out using either the remote control or the configuration menus. This procedure explains how to use the remote control to select the colour mode.

For selecting using the configuration menus
See "Video" - "Color Mode" [▶ p.74, p.77](#)

The colour mode changes as follows each time the [Color Mode] button on the remote control is pressed.

Dynamic → Presentation → Theatre → Living Room → sRGB ...

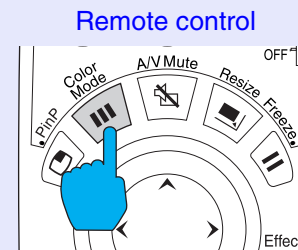

The current setting is displayed on the screen each time the mode is changed.

The default setting for the colour mode is as follows:

When computer images are being input: "Presentation"

When other types of images are being projected: "Dynamic"

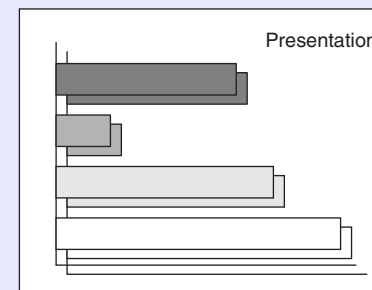

You can adjust the volume for the sound from the projector's built-in speaker or from the external speakers that are connected to the projector.



PROCEDURE

The volume can be adjusted using either the remote control, the projector's control panel or the configuration menus. This procedure explains how to use the remote control and the projector's control panel to adjust the volume.

For adjustment using the configuration menus:

See "Audio" - "Volume"  p.78

Press the [Volume] button on either the remote control or the projector's control panel.

When the button is pressed to the [] side, the volume increases, and when it is pressed to the [] side, the volume decreases.

The volume gauge appears on the screen when the volume is being adjusted.

Remote control

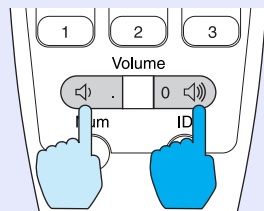

TIP

- *If the value displayed in the gauge on the screen stops changing when the volume is being adjusted, it indicates that the limit for volume adjustment has been reached.*
- *The volume adjustments are stored individually for each image source.*

Advanced Operations



This chapter describes functions for enhancing the projection of images, and how to use the configuration menus.

Functions for Enhancing Projection 58

- **A/V Mute Function**58
- **Freeze Function**59
- **E-Zoom Function**59
- **P in P (Picture in Picture) Function**60
- **Effect Function**62
 - Using the Pointer Icon 62
 - Drawing Straight and Curved Lines 63
- **Preset Function**.....64
 - Saving "Video" Menu Settings 64
 - Applying Saved "Video" Menu Settings..... 66
- **Changing the Resize/Aspect Ratio**.....66
 - Selecting the Computer Display Method..... 66
 - Projecting Wide-screen Images from Video Equipment 68
- **Projector ID/Remote Control ID**69
 - Registering an ID Number for a Projector..... 69
 - Registering an ID Number for a Remote Control..... 70

Using the Configuration Menu Functions 72

- **List of Functions**.....73
 - "Video" Menu 73
 - "Audio" Menu..... 78
 - "Effect" Menu 79
 - "Setting" Menu 80
 - "User's Logo" Menu 82

- "Advanced1" Menu83
- "Advanced2" Menu86
- "About" Menu88
- "Reset All" Menu89
- **Using the Configuration Menus** 90

Projector Monitoring and Control using a Network 92

- **Compatible Computers**..... 92
 - Computers that can run EMP Monitor92
 - Computers that can run EMP NetworkManager92
- **Installing and Uninstalling the Projector Software**..... 93
 - Installing the software93
 - Uninstalling the software.....94
- **Network Cable Connections** 94
- **Projector Connection Settings**..... 95
 - Network connections using the configuration menus95
- **Problem Reporting Using the Mail Notification Function** 96
 - Mail Notification Settings97
 - If a Problem Notification is Sent By Mail.....99
 - Connecting Manually100
 - Sharing EMP Monitor settings101
- **Centralised Monitoring and Controlling of Projectors (EMP Monitor)** 101

This section describes the various useful functions that can be used to enhance presentations.

A/V Mute Function

This function momentarily pauses the images and sound. For example, it can be used when you do not wish to show details of operations such as selecting different files while computer images are being projected. However, if you use this function when projecting moving images, the images and sound will still continue to be played back by the source, and you cannot return to the point where the A/V Mute function was activated.

PROCEDURE

Press the [A/V Mute] button on either the remote control or the projector's control panel.

The images and sound will then be paused.

Press the [A/V Mute] button once more to continue normal projection.

You can also continue normal projection by pressing the [ESC] key on either the remote control or the projector's control panel.

Remote control

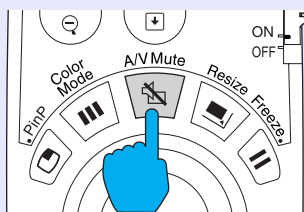

You can use the "A/V Mute" command in the "Setting" menu to set the screen appearance when the images and sound have been paused to any one of the following three settings. [p.80](#)

Solid black

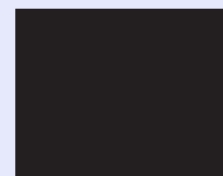

Default setting

Solid blue

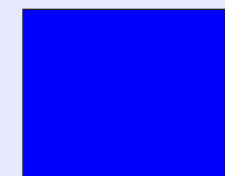

User's logo

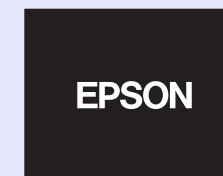

TIP

- *The default user's logo is the EPSON logo. You can change the user's logo by recording and setting your own logo. [p.129](#)*
- *If the screen appearance when using the A/V Mute function is set to "Black", the signals being input to the projector can still be viewed on an external monitor even when the A/V Mute function is being used. You can use the [Source] buttons on the remote control to select the input source while viewing the images on the external monitor at this time. [p.32](#), [p.38](#)*

Freeze Function

This function pauses only the projected images. The sound keeps playing without pausing.

The signal source will still be playing back the images even while projection is paused, and so it will not be possible to resume projection from the point where it was paused.

PROCEDURE

Press the [Freeze] button on the remote control.

The images will then be paused.

To continue projecting the images, press the [Freeze] button once more. You can also continue normal projection by pressing the [ESC] button on either the remote control or the projector's control panel.

Remote control

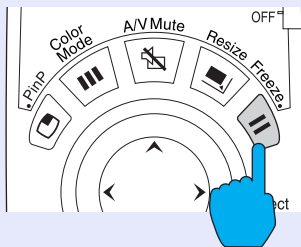

TIP

- *If you press the [Freeze] button on the remote control while a configuration menu or help menu is displayed, the configuration menu and help menu display is cancelled.*
- *The Freeze function also works while the E-Zoom function is being used.*

E-Zoom Function

This function lets you enlarge and reduce parts of projected images such as graphs and tables.

The E-Zoom function is controlled using the remote control.

PROCEDURE

1 Press the [E-Zoom +] button on the remote control.

A cursor (cross) indicating the centre point for the area to be enlarged will appear on the screen.

Remote control

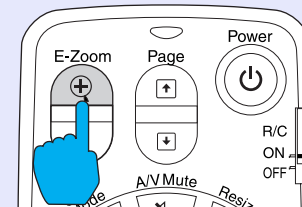

2 Move the cross to the area of the image that is to be enlarged.

Tilt the [◂] button on the remote control to move the cross.

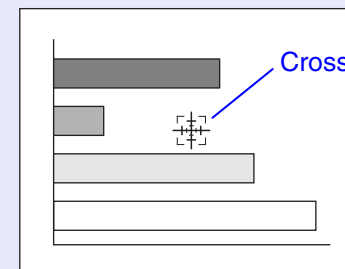

3 When the [⊕] button is pressed, the image is enlarged with the cross at its centre. When the [⊖] button is pressed, the enlarged image is then reduced.

The enlargement ratio will appear at the bottom-right of the screen.

You can scroll around the image by tilting the [⊙] button.

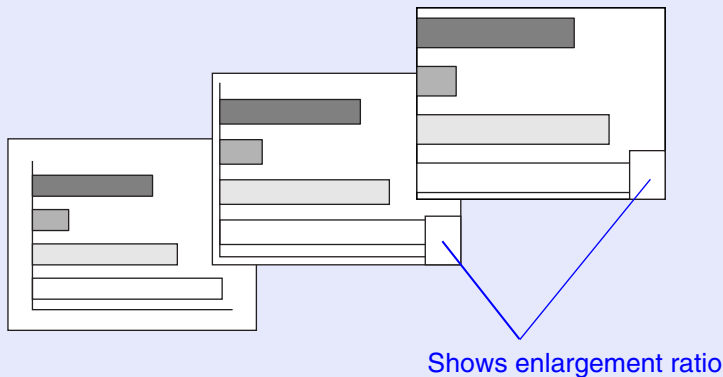

To cancel the E-Zoom function, press the [ESC] button.



TIP

The selected area can be enlarged to between 1–4 times, in 25 steps of $\times 0.125$.

P in P (Picture in Picture) Function

This function lets you display separate images in a smaller screen (sub-screen) over the top of the images that are currently being projected (main screen).

Computer images can be displayed in the main screen, and video images ([composite video](#) or [S-Video](#)) can be displayed in the sub-screen.

The video images in the sub-screen can be selected using the "P in P" command in the "Setting" menu. [p.80](#)

The P in P function is controlled using the remote control.



TIP

The P in P function cannot be used for computer images that have the [refresh rate](#) set to [interlaced](#), nor for RGB video images.

PROCEDURE

1

Connect the equipment to be used for projecting the main screen and sub-screen images, set the type of sub-screen using the "P in P" command in the "Setting" menu, and then press the [PinP] button on the remote control.

The sub-screen will appear at the top-left of the screen, and the operation guide will appear at the bottom-left of the screen.

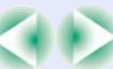
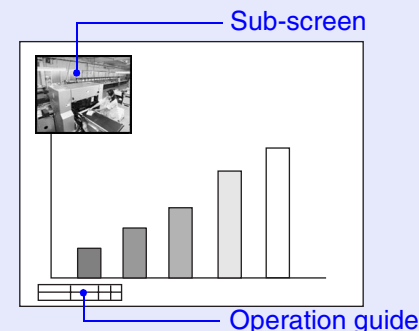

2 Tilt the [○] button on the remote control to change the position of the sub-screen.

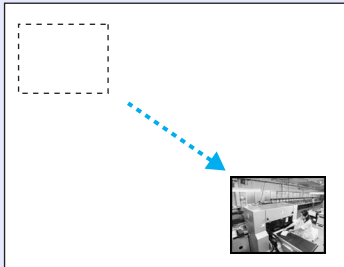

3 Press the [E-Zoom] button on the remote control to change the size of the sub-screen to one of five available sizes.

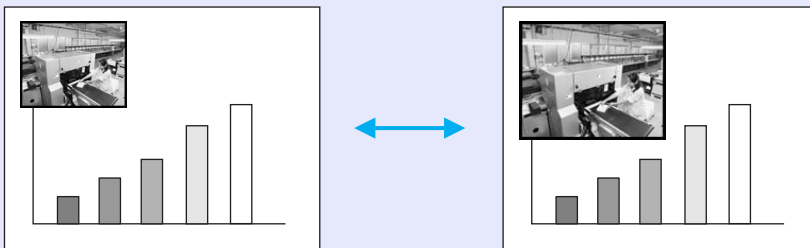

The values given below are the ratios for the sides of the sub-screen when the width and height of the main screen is 1.

Size 1	Size 2	Size 3	Size 4	Size 5
Approx.	Approx.	Approx.	Approx.	Approx.
1/3.4	1/3.2	1/3.0	1/2.8	1/2.7

Size 2 is the default size for the sub-screen when the [PinP] button is pressed.

4 When you press the [Enter] button, the operation guide will disappear and the display position and size for the sub-screen will be accepted.

When the display position and size for the sub-screen are accepted, the operation guide disappears. To cancel the P in P function, press the [PinP] button once more.



TIP

- *The position of the sub-screen is memorised, so that the sub-screen will appear in the last position which was set next time the P in P function is used.*
- *Before setting the display position and size for the sub-screen, you can carry out the following operations to switch the sound output between the main screen and the sub-screen.*
 - *To output the sound for the main screen: Press the [Color Mode] button.*
 - *To output the sound for the sub-screen: Press the [A/V Mute] button.*



Effect Function

You can display a pointer icon on the images being projected, and then use the remote control to draw straight and curved lines.

This function can be used to emphasise parts of an image that you want to draw attention to.

The Effect function is controlled using the remote control.



TIP

You can use the "Effect" menu to change various settings for the pointer icon, such as type, size, movement speed, and the colour and thickness of the line that is drawn. The selected settings can be saved as "Pointer/Line1", "Pointer/Line2" or "Pointer/Line3" and then retrieved when required. [p.79](#)

Using the Pointer Icon

You can use the pointer icon to draw attention to parts of projected images that you would like to explain about during a presentation, for example.

PROCEDURE

1 Press the [Effect] button on the remote control.

The pointer icon will appear in the middle of the projection area. The pointer icon will change to the icon set for "Pointer/Line1", "Pointer/Line2" and "Pointer/Line3" in that order each time the [Effect] button is pressed.

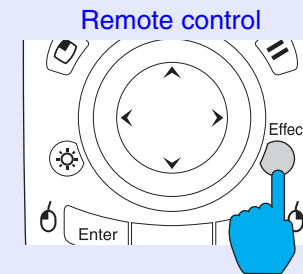

2 Tilt the [○] button to move the pointer icon.

To cancel the Effect function, press the [ESC] button. The pointer icon will then disappear from the screen.

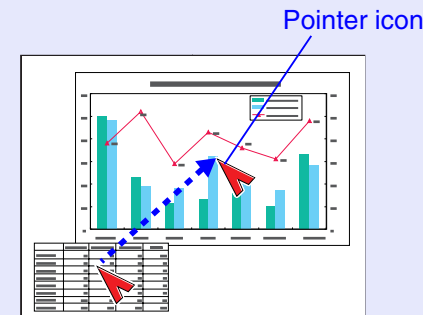



TIP

The last pointer icon type used will remain as the current pointer icon until the projector's power is turned off, so that when the Effect function is used, that pointer icon will appear. When the projector's power is turned off, the pointer icon that has been saved using the "Pointer/Line 1" command will be the first pointer icon to be displayed the next time the Effect function is used.

Drawing Straight and Curved Lines

You can draw straight lines to emphasise aspects of an image, and draw freehand lines to circle parts of the image at times such as when giving presentations.

PROCEDURE

1 Press the [Effect] button on the remote control.

The pointer icon will appear in the middle of the projection area. The pointer icon will change to the icon set for "Pointer/Line1", "Pointer/Line2" and "Pointer/Line3" in that order each time the [Effect] button is pressed, and you can then select the type of line that has also been set for that pointer type.

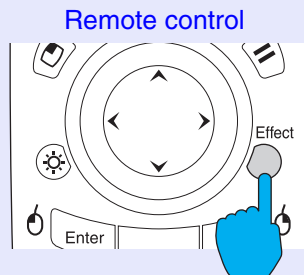

2 Set the starting point for the line.

Straight line : Move the pointer icon to the starting point for the line and press the [Enter] button.

Curved line : Move the pointer icon to the starting point for the line and hold the [Enter] button down for approximately 1.5 seconds to start drag mode. The [Enter] button will light.



3 Set the ending point for the line.

Straight line : Move the pointer icon to the ending point for the line and press the [Enter] button.

Curved line : Move the pointer icon to the ending point for the line. The path moved by the pointer icon will appear as a line drawn on the screen. Press the [Enter] or [ESC] button. The light for the [Enter] button will turn off.

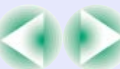
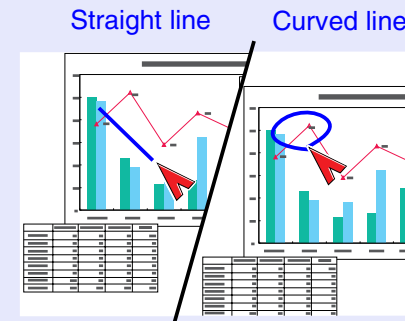



TIP

- *The thickness and colour of the line cannot be changed by pressing the [Effect] button during the time in between when the starting point is set and the ending point is accepted.*
- *Straight lines and curved lines cannot be erased individually. All lines will disappear at the same time when the Effect function is cancelled.*

4

To draw further lines, repeat steps 2 and 3.

To cancel the Effect function, press the [ESC] button. The pointer icon and the lines that have been drawn will then disappear from the screen.

Preset Function

When projecting analogue RGB video signals from a computer, you can change the settings for these signals using the "Video" menu, and up to ten different sets of these settings can be saved.

When the setting values for different resolutions and frequencies that have been made using the "Video" menu have been saved in this way, you can then load these settings and apply them to analogue RGB video signals that are currently being projected just by pressing the [Preset] button on the remote control.

Saving "Video" Menu Settings

PROCEDURE

1

Press the [Menu] button on either the remote control or the projector's control panel, and then select the "Video" menu from the main menu. Then make the settings that you would like to be saved. [p.73](#)

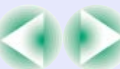
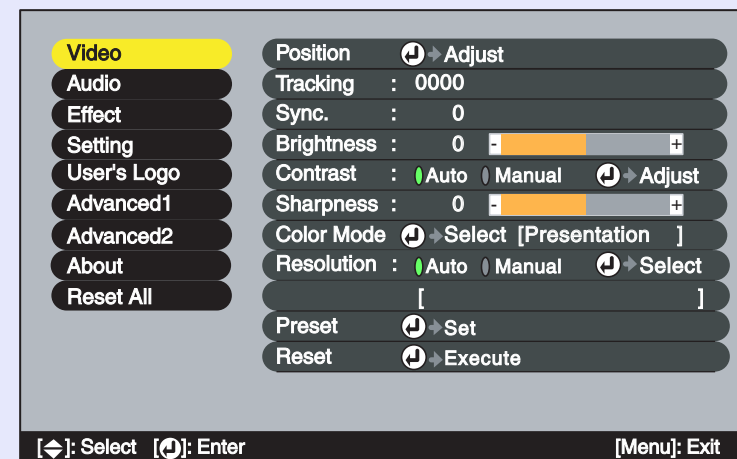

- 2 Once the settings have been made, select "Preset" in the sub-menu and then press the [Enter] button on the remote control or the [Auto/Enter] button on the projector's control panel.

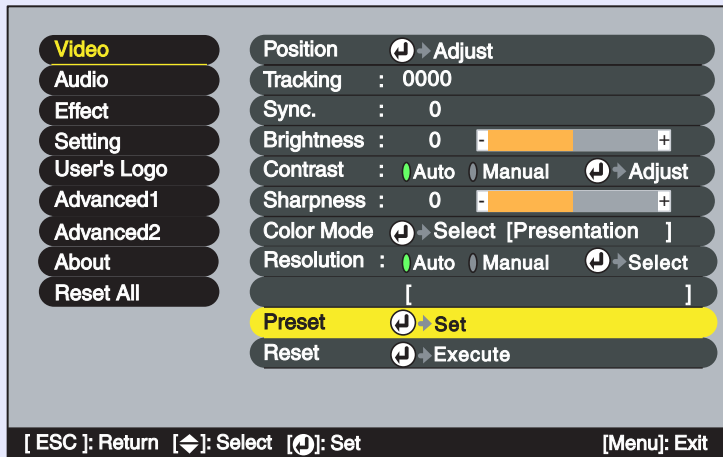

- 3 Select a number (1–10) for saving the settings.



TIP

The preset numbers that have an input resolution displayed have already been set. If you select a preset number that has already been set and use it to save the current settings, the existing settings in that recording area will be overwritten.



TIP

- 4 Press the [Enter] button on the remote control or the [Auto/Enter] button on the projector's control panel to save the "Video" menu settings.

When the settings have been saved, the input resolution will appear.

Remote control

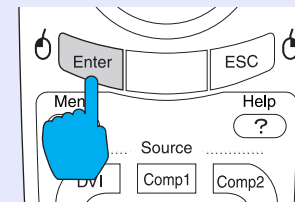

TIP

To clear the memorised details, select "Reset" from the "Video" menu. Note that this will clear all of the preset settings.



■ Applying Saved "Video" Menu Settings

PROCEDURE

While projecting analogue RGB images from a computer, press the [Preset] button on the remote control to apply the saved setting values for the "Video" menu to the images that are currently being projected.

The memorised preset number changes in ascending order starting from the lowest recording area number each time the button is pressed.

You must press the [Preset] button while the preset number and input resolution appear on the screen, otherwise the selection will not change.

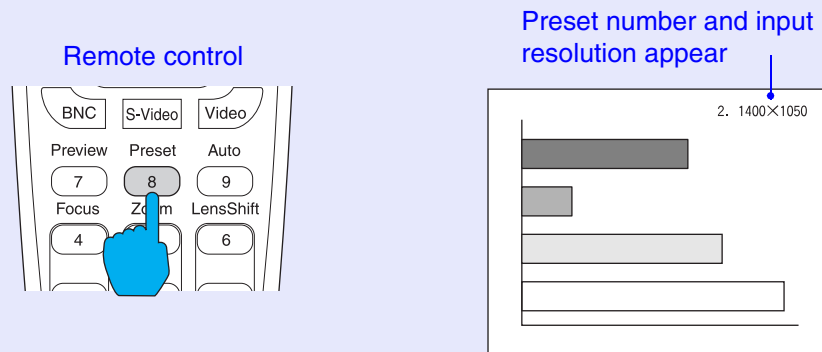

Changing the Resize/Aspect Ratio

■ Selecting the Computer Display Method

When projecting computer images, the display method can be changed between resized display (in which the images are projected so that they fill the available projection area) and real display (in which the images are projected at the resolution of the original input signal).

When projecting computer images, the default method used is resized display.

PROCEDURE

The display method switches between real display and resized display each time the [Resize] button on either the remote control or the projector's control panel is pressed.

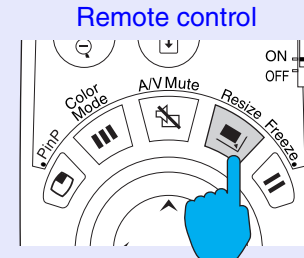

TIP

- Preset numbers that have not yet been preset will be skipped.
- If no preset settings have been made, the message "No Entry" will appear when you press the [Preset] button.



If the input resolution is lower than the panel resolution (1024 × 768)

Resized display

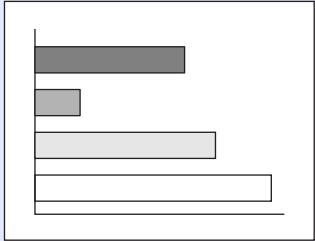

Real display

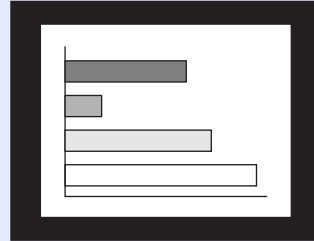

The image is projected in the middle of the screen at the original input signal resolution.

If the input resolution is higher than the panel resolution (1024 × 768)

Resized display

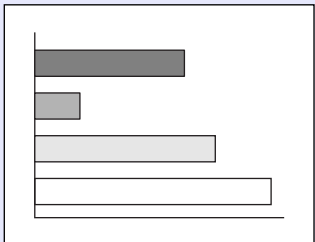

Real display

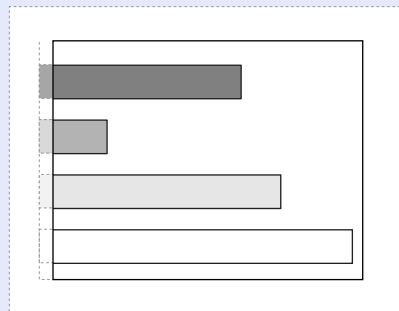

The middle section of the image is projected. You can tilt the [○] button on the remote control to scroll around the image.



TIP

- The display methods for projected images are stored individually for each video source.
- If the input resolution is the same as the panel resolution (1024 × 768 dots), the image size will not change.
- In the case of SXGA (5:4) input signals, the image position changes as shown below each time you press the [Resize] button while holding down the [Shift] button on the projector's control panel.

Resized display (5:4)

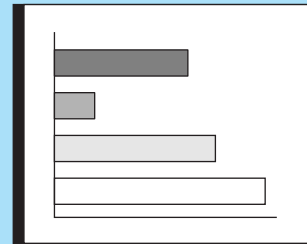

Aligned to left (5:4)

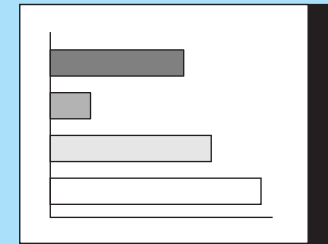

Resized display (4:3)

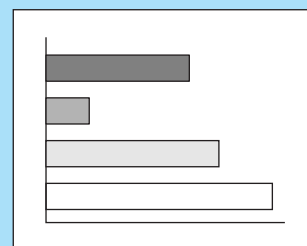

Aligned to right (5:4)

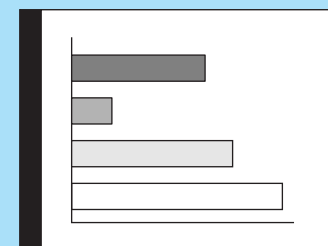

Projecting Wide-screen Images from Video Equipment

You can switch the [aspect ratio](#) between 4:3 and 16:9 when [component video](#) (YCbCr and YPbPr), [S-Video](#) and composite video signals are being projected. Images that have been recorded in digital video and DVD images can be projected in 16:9 wide-screen format.

PROCEDURE

The display changes each time you press the [Resize] button on either the remote control or the projector's control panel.

Remote control

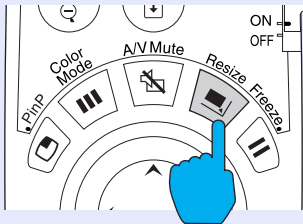

For SDTV

When images that are output in 16:9 format are displayed at an aspect ratio of 4:3, the images are squeezed horizontally so that they appear vertically elongated.

When images in [squeeze mode](#) are projected at 4:3

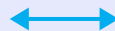
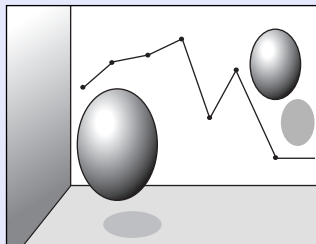

When images in [squeeze mode](#) are projected at 16:9

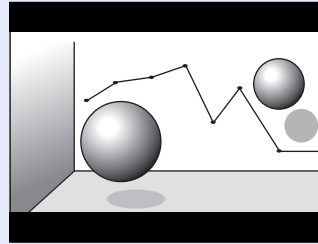

For HDTV

When images that are output in 16:9 format are displayed at an aspect ratio of 4:3, the images are resized so that they fill the full vertical area of the screen, and the left and right edges are truncated and are not displayed.

When images in [squeeze mode](#) are projected at 16:9

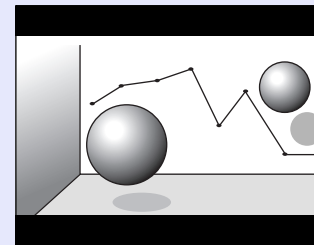

When images in [squeeze mode](#) are projected at 4:3

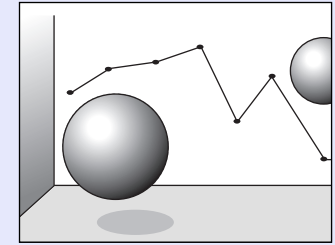

Projector ID/Remote Control ID

If using more than one projector at a time, such as at a show, you can record ID numbers for the projectors and for the remote controls in order to simultaneously operate projectors with the same ID number. Alternatively, if you set the remote control ID to "0", all projectors can be operated by the remote control regardless of the projector ID numbers.



TIP

The default values for ID numbers are "1" for projectors and "0" for remote controls.

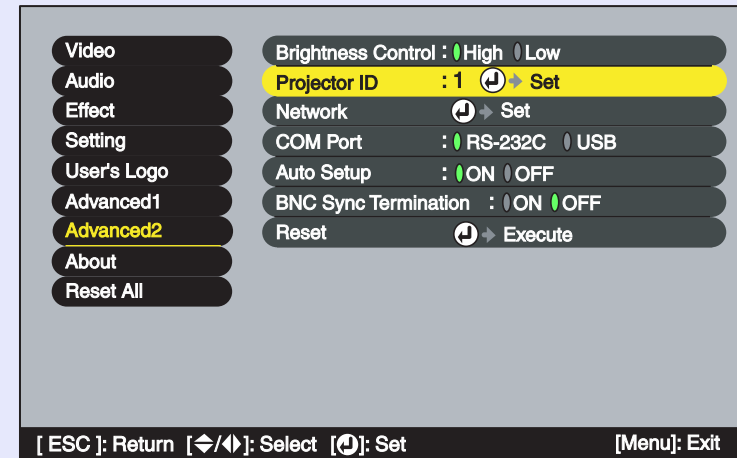

TIP

The numbers that can be used for the "Projector ID" setting are from "1" to "9". "Projector ID" cannot be set to "0".

■ Registering an ID Number for a Projector

PROCEDURE

- 1 Press the [Menu] button on either the remote control or the projector's control panel, and then select "Projector ID" from the "Advanced2" menu.

See "Using the Configuration Menus" for details on this operation.

p.90

Remote control

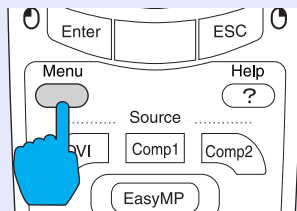

- Use the [○] button on the remote control or the [Tracking +] or [Tracking -] button on the projector's control panel to select the desired ID number (1–9).

Press the [Enter] button on the remote control or the [Auto/Enter] button on the projector's control panel to accept the ID number setting.

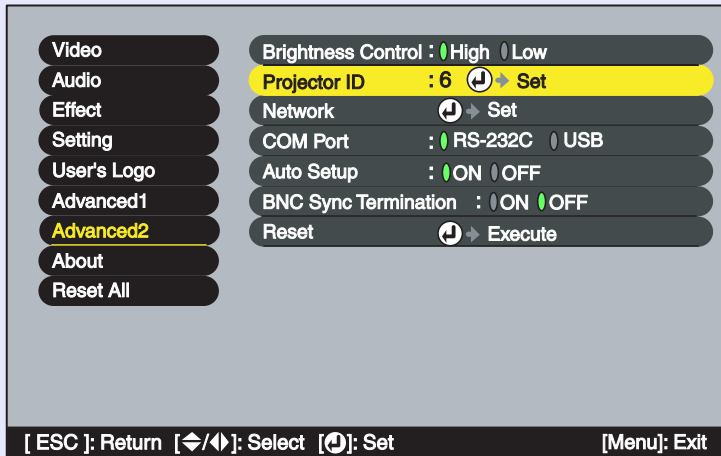

- Once the setting has been made, press the [Menu] button to close the configuration menu.

When the ID number is registered, the projector cannot be operated by remote control unless the remote control used has the same ID number or has an ID number of "0".

Registering an ID Number for a Remote Control

PROCEDURE

- Press the [ID] button on the remote control.
The [ID] button will light.

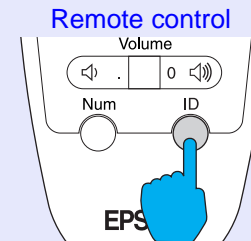

- Press the [0] to [9] buttons on the remote control to specify the ID number for the remote control.

The light for the [ID] button will turn off and the registration will be complete. If a number other than "0" is registered, the remote control will only be able to operate projectors that have the same ID number.

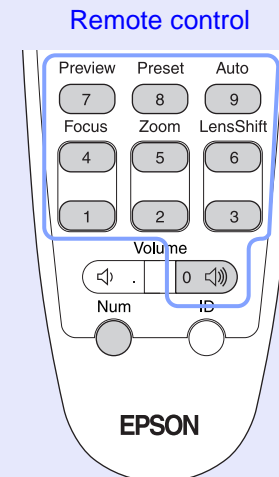



TIP

If you would like to check the ID number that is currently set for a remote control, press the [ID] button on the remote control so that the button lights, and then press the [ID] button once more. After a brief period, the [ID] button will flash, and the number of flashes will equal the remote control's ID number.



The configuration menus can be used to carry out a variety of settings and adjustments.

The menus have a hierarchical structure, with a main menu that is divided into sub-menus, which are further divided into other sub-menus.



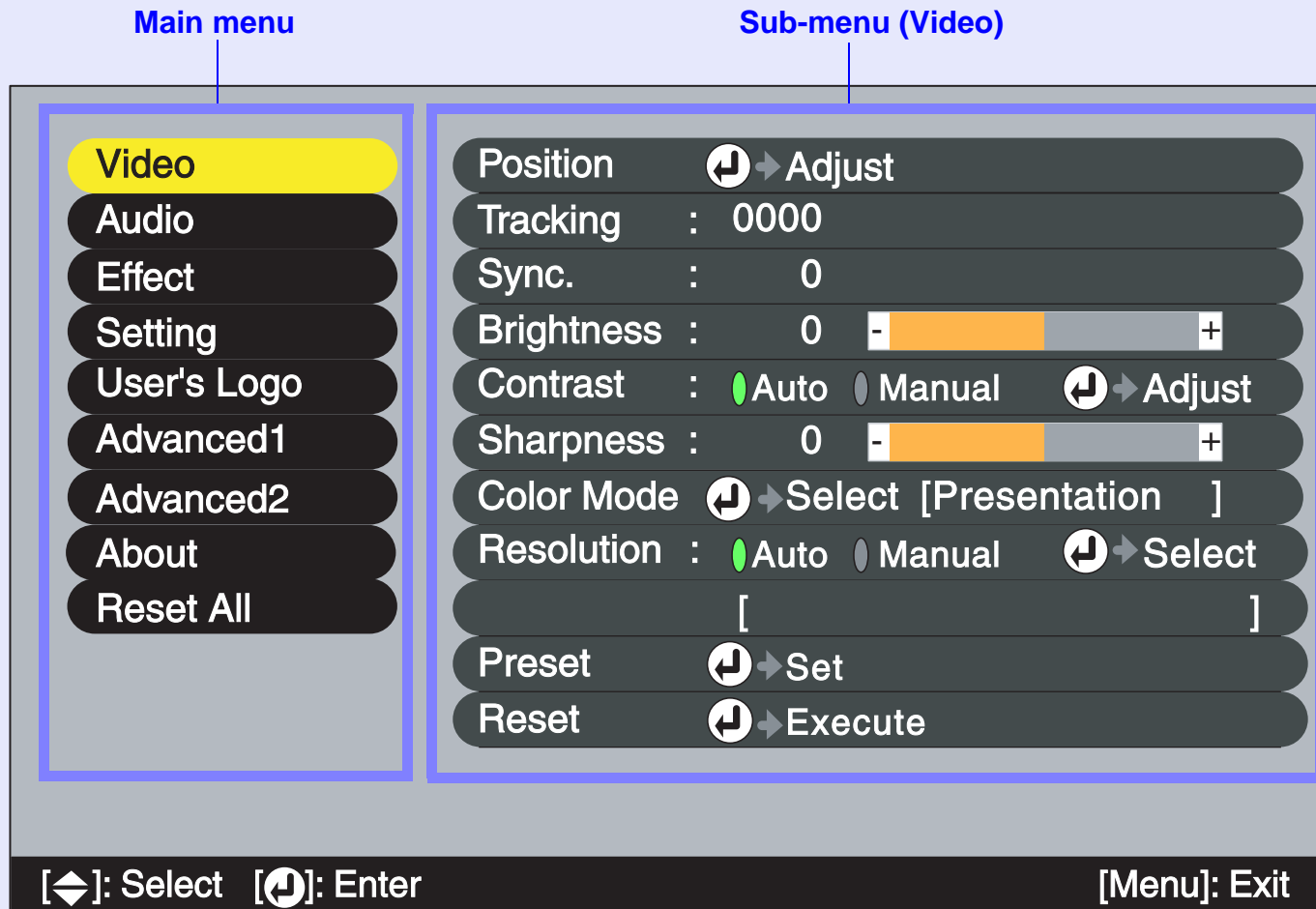



Refer to "Using the Configuration Menus" ( p.90) for details on using the menus.



Main menu

- Video
- Audio
- Effect
- Setting
- User's Logo
- Advanced1
- Advanced2
- About
- Reset All

Sub-menu (Video)

- Position   Adjust
- Tracking : 0000
- Sync. : 0
- Brightness : 0   
- Contrast : Auto Manual   Adjust
- Sharpness : 0   
- Color Mode   Select [Presentation]
- Resolution : Auto Manual   Select
- []
- Preset   Set
- Reset   Execute

[]: Select []: Enter [Menu]: Exit

List of Functions

"Video" Menu

- The functions in the "Video" menu apart from "Resolution" and "Video Signal" cannot be adjusted while no video signal is being input.
- The functions which appear in the "Video" menu will change depending on the type of input source being projected. Functions which are not available in the "Video" menu for a particular input source cannot be adjusted.

Computer (Analogue RGB)

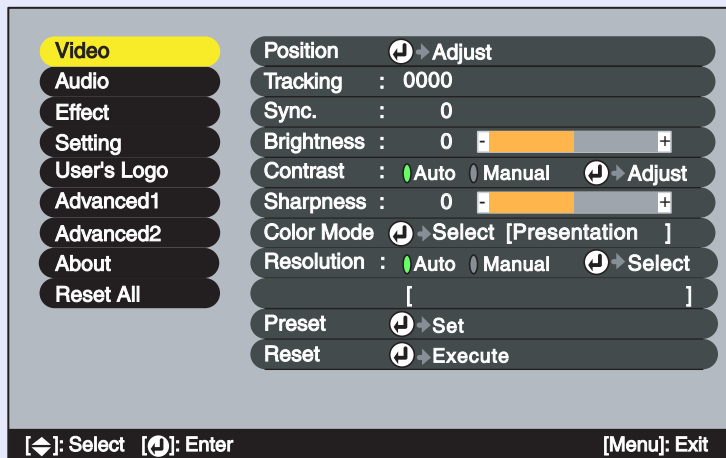

Computer (Digital RGB)

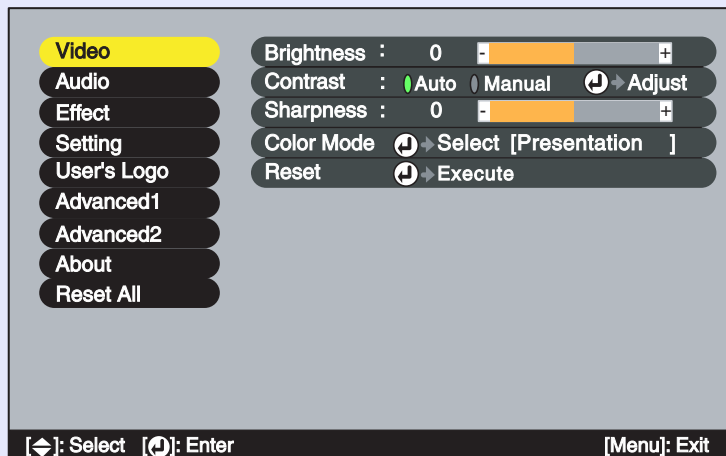

Sub-menu	Function	Default
Position	(Adjustment is only possible when analogue RGB signals are being input) Moves the image display position vertically and horizontally. • Press the [Enter] button on the remote control or the [Auto/Enter] button on the projector's control panel and make the adjustment.	Depends on connection
Tracking ▶▶	(Adjustment is only possible when analogue RGB signals are being input) Adjusts computer images when vertical stripes appear in the images.	Depends on connection
Sync. ▶▶	(Adjustment is only possible when analogue RGB signals are being input) Adjusts computer images when flickering, fuzziness or interference appear in the images. • Flickering and fuzziness may also occur when the brightness, contrast ▶▶, sharpness and keystone correction settings are adjusted. • You can obtain the best results if you adjust the tracking first and then adjust the synchronization.	Depends on connection
Brightness	Adjusts the image brightness.	Median value (0)
Contrast ▶▶	Adjusts the difference between light and shade in the images. • Auto : The contrast is adjusted automatically to the ideal level. • Manual: Contrast is adjusted manually.	Auto
Sharpness	Adjusts the image sharpness.	Median value (0)



Sub-menu	Function	Default
Color Mode	<p>Corrects the vividness of the image colour. The settings can be saved separately for each type of source (computer or video source).</p> <p>You can select from five different quality settings depending on the surroundings.</p> <ul style="list-style-type: none"> •Dynamic : Images are modulated and made fresher to emphasise brightness. •Presentation: Brightness is emphasized. For presentations in bright rooms. •Theatre : Movie images are optimised using natural tints. •Living Room: Brightness is emphasized. Ideal for playing video games in bright rooms. •sRGB : Images conform to the sRGB standard. If set to "sRGB", the colour temperature for the "Color Adjustment" command in the "Advanced1" menu will be set to 6500K. 	Presentation
Resolution	<p>(Selection is only possible when analogue RGB signals are being input and are selected)</p> <p>Sets the input resolution for the signal source being used.</p> <ul style="list-style-type: none"> •Auto : The input resolution is set automatically in accordance with the input signal. •Manual: The input resolution is selected manually. 	Auto
Preset	<p>(Recording is only possible when analogue RGB signals are being input)</p> <p>Allows "Video" menu settings to be saved and then applied to analogue RGB images that are being projected by pressing the [Preset] button on the remote control.</p> <ul style="list-style-type: none"> •The current settings are saved when a preset number (1 to 10) is selected. Preset numbers which already have saved settings show the input resolution that has been set. If setting values have been changed, existing settings that have been saved under a preset number can be overwritten by selecting that preset number. 	-

Sub-menu	Function	Default
Reset	Resets all adjustments values for the "Video" menu functions to their default settings. <ul style="list-style-type: none">• Press the [Enter] button on the remote control or the [Auto/Enter] button on the projector's control panel to reset.• Select "Reset All" to reset all menu settings – including settings for the "Video" and "Audio" menus – to their default settings.  p.89	-



[Component Video](#) ([YCbCr](#), [YPbPr](#))

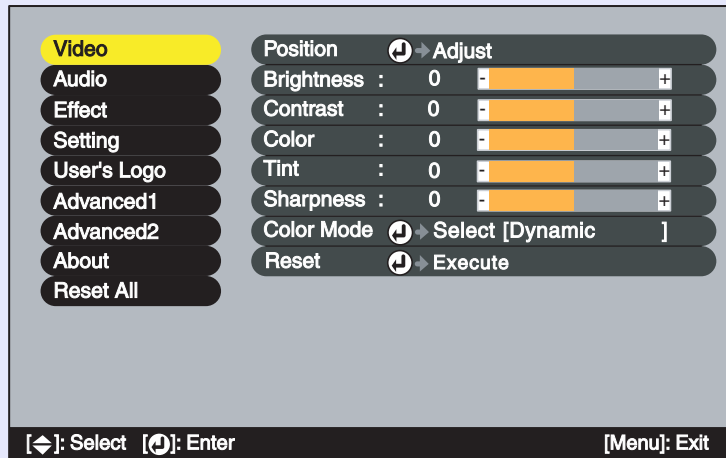

Video ([Composite video](#), [S-Video](#))



RGB Video

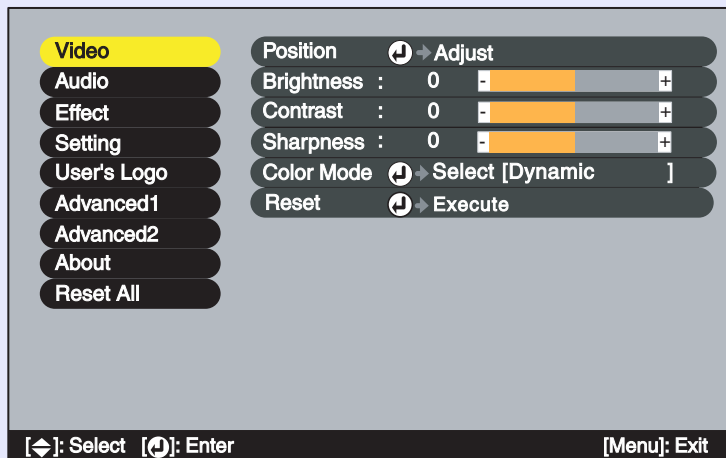

Sub-menu	Function	Default
Position	Moves the image display position vertically and horizontally. •Press the [Enter] button on the remote control or the [Auto/Enter] button on the projector's control panel and make the adjustment.	Depends on connection
Brightness	Adjusts the image brightness.	Median value (0)
Contrast	Adjusts the difference between light and shade in the images.	Median value (0)
Color	(Does not appear when the input source is RGB video.) Adjusts the colour intensity for the images.	Median value (0)
Tint	(Does not appear when the input source is RGB video.) Adjusts the image tint.	Median value (0)
Sharpness	Adjusts the image sharpness.	Median value (0)



Sub-menu	Function	Default
Color Mode	<p>Corrects the vividness of the image colour. The settings can be saved separately for each type of source (computer or video source).</p> <p>You can select from five different quality settings depending on the surroundings.</p> <ul style="list-style-type: none"> •Dynamic : Images are modulated and made fresher to emphasise brightness. •Presentation: Brightness is emphasized. For presentations in bright rooms. •Theatre : Movie images are optimised using natural tints. The black & white extension function operates so that differences in colour gradations (darkness and lightness of colours) are accentuated even for images that are very dark or very bright, to make them easier to view. •Living Room: Brightness is emphasized. Ideal for playing video games in bright rooms. •sRGB : Images conform to the sRGB standard. If set to "sRGB", the colour temperature for the "Color Adjustment" command in the "Advanced1" menu will be set to 6500K. 	Dynamic
Video Signal	<p>(Selection is only possible when composite video/S-Video signals are being input and are selected)</p> <p>Selects the video signal format.</p> <ul style="list-style-type: none"> •Press the [Enter] button on the remote control or the [Auto/Enter] button on the projector's control panel and choose the setting. •When set to "Auto", the video signal format is selected automatically. 	Auto
Reset	<p>Resets all adjustments values for the "Video" menu functions to their default settings.</p> <ul style="list-style-type: none"> •Press the [Enter] button on the remote control or the [Auto/Enter] button on the projector's control panel to reset. •Select "Reset All" to reset all menu settings – including settings for the "Video" and "Audio" menus – to their default settings.  p.89 	-



"Audio" Menu

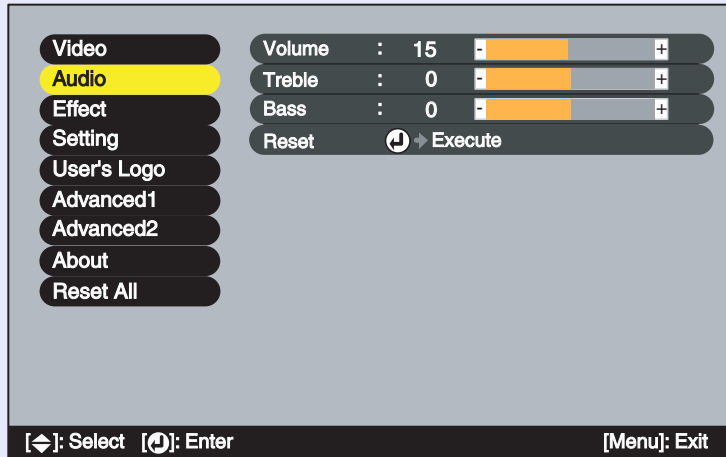

Sub-menu	Function	Default
Volume	Adjusts the volume.	15
Treble	Adjusts the intensity of the treble range.	Median value (0)
Bass	Adjusts the intensity of the bass range.	Median value (0)
Reset	<p>Resets all adjustments values for the "Audio" menu functions to their default settings.</p> <ul style="list-style-type: none"> • Press the [Enter] button on the remote control or the [Auto/Enter] button on the projector's control panel to reset. • Select "Reset All" to reset all menu settings – including settings for the "Video" and "Audio" menus – to their default settings. p.89 	-



TIP

The "Audio" menu settings are saved individually for each input signal source.

■ "Effect" Menu

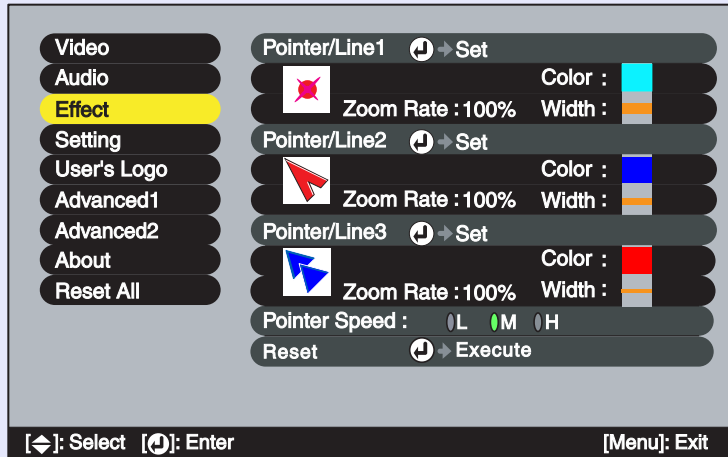

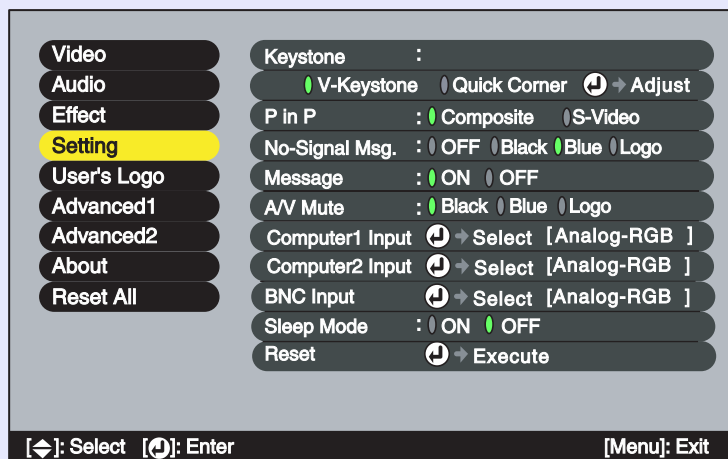

Sub-menu	Function	Default
Pointer/ Line1	<p>Sets the pointer or line that is displayed when the [Effect] button on the remote control is pressed once.</p> <ul style="list-style-type: none"> • Shape : Select the pointer shape from the following eight types. <ul style="list-style-type: none"> •Zoom Rate : Select the display size for the pointer icon from "100%" or "200%". •Color : Select the colour of the straight and curved lines from eight colours. •Width : Select the width of the straight and curved lines that are drawn when the pointer icon is moved from Thick, Medium or Thin. 	<p>Shape: </p> <p>Zoom Rate: 100%</p> <p>Color: Light blue</p> <p>Width: Thick</p>
Pointer/ Line2	<p>Sets the pointer or line that is displayed when the [Effect] button on the remote control is pressed twice.</p> <p>The setting items and contents are the same as for "Pointer/Line1".</p>	<p>Shape: </p> <p>Zoom Rate: 100%</p> <p>Color: Blue</p> <p>Width: Medium</p>
Pointer/ Line3	<p>Sets the pointer or line that is displayed when the [Effect] button on the remote control is pressed three times.</p> <p>The setting items and contents are the same as for "Pointer/Line1".</p>	<p>Shape: </p> <p>Zoom Rate: 100%</p> <p>Color: Red</p> <p>Width: Thin</p>
Pointer Speed	<p>Sets the speed at which the pointer moves when the [Circle] button is tilted.</p> <p>L: Low M: Medium H: High</p>	M
Reset	<p>Resets all adjustments values for the "Effect" menu functions to their default settings.</p> <ul style="list-style-type: none"> •Press the [Enter] button on the remote control or the [Auto/Enter] button on the projector's control panel to reset. •Select "Reset All" to reset all menu settings – including settings for the "Video" and "Audio" menus – to their default settings. p.89 	-

"Setting" Menu



Sub-menu	Function	Default
Keystone	<p>Corrects keystone distortion in images. Press the [Enter] button on the remote control or the [Auto/Enter] button on the projector's control panel, and then make the correction.</p> <ul style="list-style-type: none"> •V-Keystone : This operates in the same way as the [Keystone] button on the projector's control panel. It corrects vertical keystone distortion in projected images. It also corrects the image height. •Quick Corner : Corrects the four corners of the projection area to make the images fit the screen exactly. <p>If the images become uneven in appearance after keystone correction is carried out, adjust using the "Sharpness" command in the "Video" menu. p.73, p.76</p>	<p>V-Keystone: Median value (0)</p> <p>Height: Median value (0)</p> <p>Quick Corner: No correction</p>
P in P	<p>When using the P in P function, this selects whether the image signals that are projected into the sub-screen are composite video or S-Video signals.</p>	Composite
No-Signal Msg.	<p>Sets the message status and background colour at times such as when no video signal is being input. When set to "OFF", the background colour becomes black and no message is displayed.</p> <ul style="list-style-type: none"> •To change the user's logo, you need to record your own logo. p.129 	Blue
Message	<p>Selects whether the image signal name or colour mode name is displayed on the screen (ON) or not displayed (OFF) when switching the video signal or colour mode.</p>	ON
A/V Mute	<p>Sets the screen status when the [A/V Mute] button is pressed.</p> <p>The images for the input signal are displayed unchanged on an external monitor while the A/V Mute function is being used only when "A/V Mute" is set to "Black". p.32</p> <ul style="list-style-type: none"> •To change the user's logo, you need to record your own logo. p.129 	Black
Computer1 Input	<p>Selects the video signal to match the device that is connected to the [Computer 1] port.</p>	Analog-RGB



Sub-menu	Function	Default
Computer2 Input	Selects the video signal to match the device that is connected to the [Computer 2] port.	Analog-RGB
BNC Input	Selects the video signal to match the device that is connected to the [BNC] port.	Analog-RGB
Sleep Mode	<p>Sets the energy saving operation when no video signal is being input.</p> <ul style="list-style-type: none"> •When set to "ON", projection stops automatically and after the cool-down period is finished, the projector changes to sleep mode (standby mode) if no operations are carried out for approximately 30 minutes while the "No-Signal." message is being displayed. (The  indicator lights orange.) •Projection starts again when the [Power] button on either the remote control or the projector's control panel is pressed. 	OFF
Reset	<p>Resets all adjustments values for the "Setting" menu functions except for the "Computer1 Input", "Computer2 Input" and "BNC Input" settings to their default settings.</p> <ul style="list-style-type: none"> •Press the [Enter] button on the remote control or the [Auto/Enter] button on the projector's control panel to reset. •Select "Reset All" to reset all menu settings – including settings for the "Video" and "Audio" menus – to their default settings.  p.89 	-



■ "User's Logo" Menu

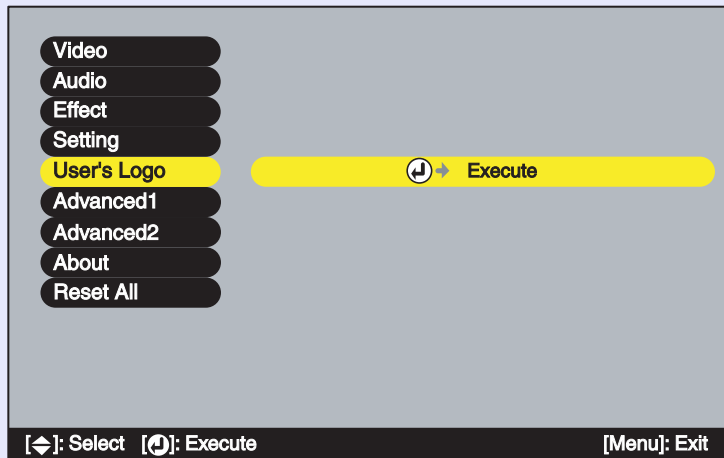

Sub-menu	Function	Default
Execute	Records a user's logo. p.129 <ul style="list-style-type: none"> • Press the [Enter] button on the remote control or the [Auto/Enter] button on the projector's control panel, and then follow the instructions that appear on the screen. 	EPSON logo

"Advanced1" Menu

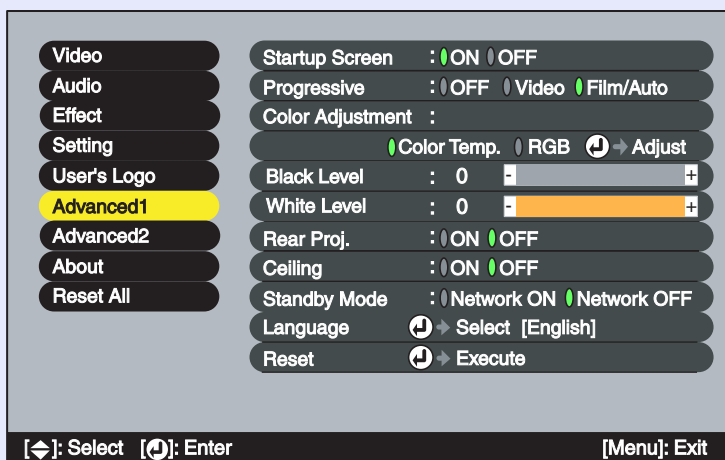

Sub-menu	Function	Default
Startup Screen	Sets whether the startup screen is displayed or not. To change the user's logo, you need to record your own logo. p.129 When this setting is changed, turn the power off, and when the cool-down period has finished, turn the power back on again. The new setting will be applied after the power turns back on.	ON
Progressive	(Setting is only possible when composite video, S-Video or component video (525i, 625i) signals are being input) Converts interlaced (i) signals to progressive (p) signals. When set to "OFF", interlaced signals are projected without conversion. <ul style="list-style-type: none"> •OFF : IP conversion is carried out for each field window. This is ideal for images with a lot of movement. •Video : The film judgment function is turned off. •Film/Auto : This setting is for normal use. The source is automatically judged to be a video source or not, and if it is a video source, the 3-2 pull-down function operates and the images are reproduced as film images with no loss in colour from the original. 	Film/Auto



Sub-menu	Function	Default
Color Adjustment	<p>Adjusts the colour temperature and intensity of each RGB (red, green, blue) colour for each input source.</p> <ul style="list-style-type: none"> •Color Temp.: Lets you adjust bright colours within a range from reddish tinges to bluish tinges. If the colour temperature is lower, colours appear reddish and colour tones appear softer. If the colour temperature is higher, colours appear bluish and colour tones appear sharper. Press the [Enter] button on the remote control or the [Auto/Enter] button on the projector's control panel and make the adjustment. •RGB : Press the [Enter] button on the remote control or the [Auto/Enter] button on the projector's control panel, select "R" (red), "G" (green) or "B" (blue) and make the adjustment. Make the adjustment while viewing the stats of the image on the screen. <p>This item cannot be selected if "sRGB" has been selected as the "Color Mode" setting in the "Video" menu.</p>	Color Temp.: Depends on connection
Black Level	Adjusts the brightness of dark shades without affecting the brightness of light shades. This is used to adjust the black level (brightness of dark shades) for projected images when several projectors are all being used together for projection at times such as during shows.	Median value (0)
White Level	Adjusts the brightness of light shades without affecting the brightness of dark shades. This is used to adjust the white level (brightness of light shades) for projected images when several projectors are all being used together for projection at times such as during shows.	Median value (0)
Rear Proj.	Use when projecting images from behind a translucent screen. When set to "ON", the projected images are horizontally reversed.	OFF

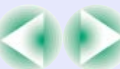

Sub-menu	Function	Default
Ceiling	Use when installing the projector on a ceiling. When set to "ON", the projected images are rotated 180° and are horizontally and vertically reversed.	OFF
Standby Mode	Set to "Network ON" to use network monitoring and control functions and the standby monitor out function while the projector is in standby mode. When this setting is changed, turn the power off, and when the cool-down period has finished, the new setting will be applied.	Network OFF
Language	Sets the language for message displays. • Press the [Enter] button on the remote control or the [Auto/Enter] button on the projector's control panel and choose the setting.	English
Reset	Resets all adjustments values for the "Advanced1" menu functions except for the "Rear Proj.", "Ceiling" and "Language" settings to their default settings. • Press the [Enter] button on the remote control or the [Auto/Enter] button on the projector's control panel to reset. • Select "Reset All" to reset all menu settings – including settings for the "Video" and "Audio" menus – to their default settings. p.89	-



"Advanced2" Menu

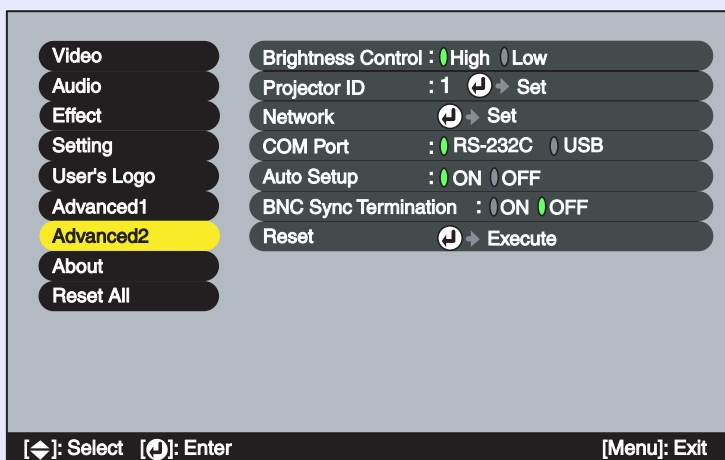

Sub-menu	Function	Default
Brightness Control	This lets you set the lamp brightness to one of two settings. Select "Low" if the images being projected are too bright such as when projecting images in a dark room or onto a small screen. When "Low" is selected, the brightness of the images is reduced, but the amount of electricity consumed and noise produced during projection are reduced and the lamp's operating life is extended.	High
Projector ID	Sets the ID number for the projector. p.69	1
Network	Sets the DHCP , IP Address , Subnet Mask and Gateway Address when the projector is connected to a network and the EMP Monitor function or mail notification function are being used. It also lets you set the IP address for a computer to use for notification of problems when using SNMP for network monitoring. p.95	-
COM Port	This can be set to either "RS-232C" or "USB" depending on the port that is being used for communication with a computer. When this setting is changed, turn the power off, and when the cool-down period has finished, turn the power back on again. The new setting will be applied after the power is turned back on.	RS-232C
Auto Setup	Selects whether the automatic adjustment function for automatically optimising images when the input source is switched to computer analogue images.	ON
BNC Sync Termination	Sets the termination mode for the [BNC] port. This is used for image terminal processing. •ON : Analogue (75 Ω) termination •OFF: TTL (Normal signal level output by the computer) input This should normally be set to "OFF". If an analogue (75 Ω) termination such as for a switcher is required, change the setting to "ON".	OFF



Sub-menu	Function	Default
Reset	<p>Resets all adjustments values for the "Advanced2" menu functions except for the "Projector ID" and "Network" settings to their default settings.</p> <ul style="list-style-type: none">• Press the [Enter] button on the remote control or the [Auto/Enter] button on the projector's control panel to reset.• Select "Reset All" to reset all menu settings – including settings for the "Video" and "Audio" menus – to their default settings.  p.89	-



"About" Menu

- The "About" menu shows the setting details for the current input signal.
- The "Lamp" item appears as "0H" for 0–10 hours, and after that it appears in units of 1 hour.

Computer (Analogue RGB, Digital RGB)/
[Component Video](#) (YCbCr) / [YPbPr](#) /
 RGB Video

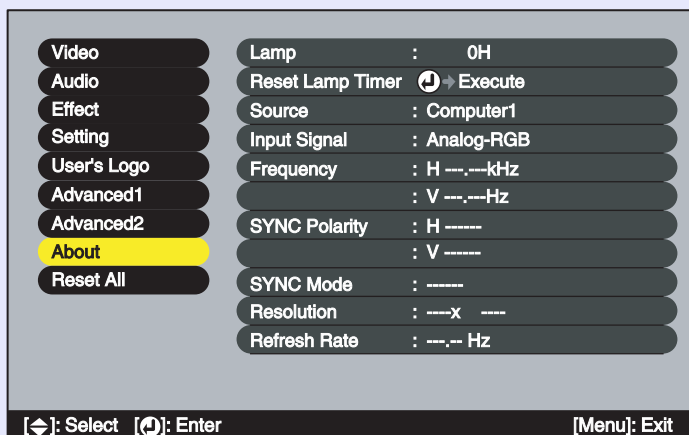

Video ([Composite Video](#), [S-Video](#))

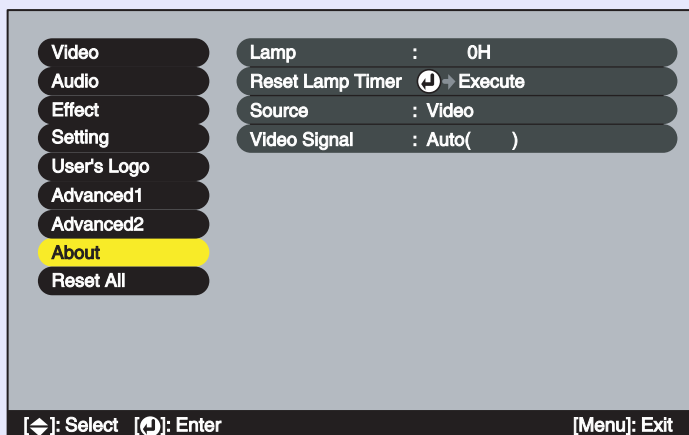

Sub-menu	Function	Default
Lamp	Displays the cumulative lamp operating time. •When the lamp warning period is reached, the display characters appear in red.	0H
Reset Lamp Timer	Initialises the lamp operating time. When this command is selected, the cumulative lamp operating time is reset to the initial default value.	-
Source	Displays the input source which is currently being projected.	
Input Signal	Displays the input signal settings. (Does not appear when the input source is composite video or S-video.)	
Video Signal	Shows the video signal format. (Does not appear when the input source is a computer, component video or RGB video.)	-
Frequency	Displays the horizontal and vertical scanning frequencies. (Does not appear when the input source is composite video or S-video.)	-
SYNC	Displays the sync polarity. (Does not appear when the input source is composite video or S-video.)	-
Polarity		
SYNC Mode	Displays the sync attributes. (Does not appear when the input source is composite video or S-video.)	-
Resolution	Displays the input resolution. (Does not appear when the input source is composite video or S-video.)	-
Refresh Rate	Displays the refresh rate. (Does not appear when the input source is composite video or S-video.)	-

"Reset All" Menu

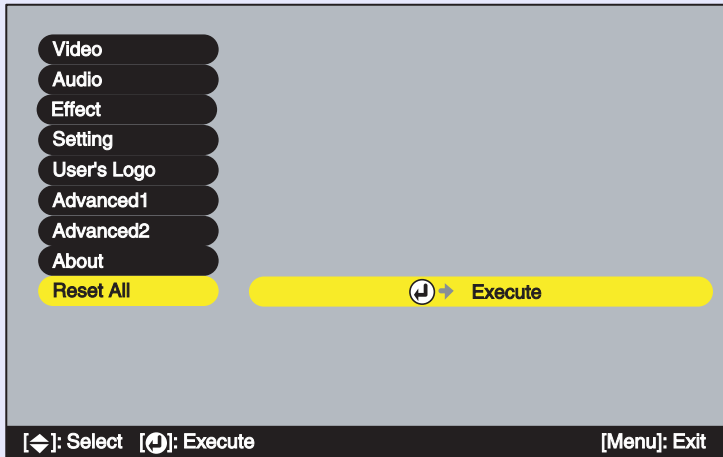

Sub-menu	Function	Default
Execute	<p>Resets all items in all configuration menus to their default settings.</p> <ul style="list-style-type: none"> • Press the [Enter] button on the remote control or the [Auto/Enter] button on the projector's control panel to reset. • Select "Reset" in an individual sub-menu such as the "Video" or "Audio" menu to reset only the settings for the items in each sub-menu. • The "Computer1 Input", "Computer2 Input", "BNC Input", "User's Logo", "Language", "Projector ID", "Network" and "Lamp" settings will not be reset. 	-

Using the Configuration Menus

The configuration menus can be operated using either the remote control or the projector's control panel.

PROCEDURE

1 Press the [Menu] button on either the remote control or the projector's control panel.

The main configuration menu appears.

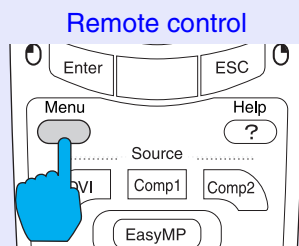

2 Select a main menu item.

If using the remote control, tilt the [⊙] button up or down to select a menu item.

If using the projector's control panel, press the [Sync +] or [Sync -] button to select a menu item.

The sub-menu items vary depending on the item selected in the main menu.

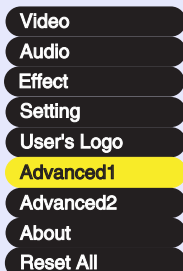

3 Confirm the selection.

If using the remote control, press the [Enter] button to confirm a selection.

If using the projector's control panel, press the [Auto/Enter] button to confirm a selection.

The cursor will be displayed in the sub-menu and settings can then be made.

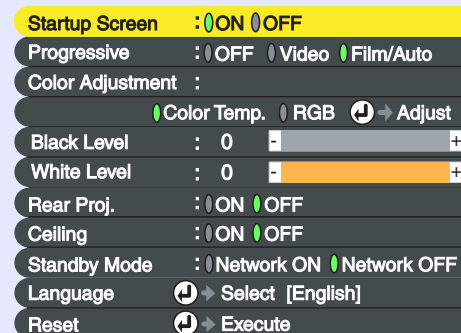

4 Select a sub-menu item.

If using the remote control, tilt the [⊙] button up or down to select a sub-menu item.

If using the projector's control panel, press the [Sync +] or [Sync -] button to select a sub-menu item.

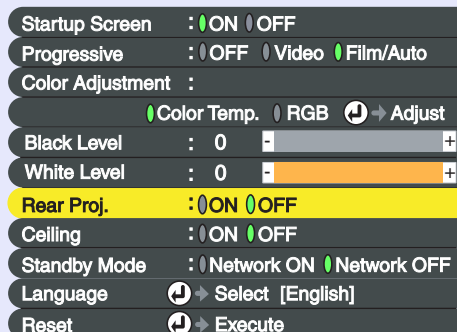



TIP

The items appearing in the "Video" menu and the "About" menu will vary depending on the type of input source being projected.

5 Select a setting value.

Tilt the [○] button on the remote control or press the [Tracking +] or [Tracking -] button on the projector's control panel to change setting values.

For items which are currently set, a 0 appears in green next to the setting. If you tilt the [○] button on the remote control or press the [Tracking +] or [Tracking -] button on the projector's control panel to select an item to be set, the 0 will appear in orange. After making the selection, press the [Enter] button on the remote control or the [Auto/Enter] button on the projector's control panel to accept the setting. When the setting is accepted, the 0 changes to green.

Startup Screen	: 0 ON 0 OFF
Progressive	: 0 OFF 0 Video 0 Film/Auto
Color Adjustment	:
	0 Color Temp. 0 RGB 0 Adjust
Black Level	: 0 [Slider]
White Level	: 0 [Slider]
Rear Proj.	: 0 ON 0 OFF
Ceiling	: 0 ON 0 OFF
Standby Mode	: 0 Network ON 0 Network OFF
Language	0 Select [English]
Reset	0 Execute



TIP

- Sub-menu items which cause another sub-menu to be displayed when they are selected have ☺ after them. If you select such menu items and press the [Enter] button on the remote control or the [Auto/Enter] button on the projector's control panel, you can then change the settings in the next sub-menu which appears.
- Refer to "List of Functions" for details on the functions of each menu item. [p.73](#)

6

Select other menu items in the same way.

Repeat steps 2 to 5 to change the settings for other menu items. To return to a previous menu, press the [ESC] button on either the remote control or the projector's control panel.

7

Close the menu.

Press the [Menu] button on either the remote control or the projector's control panel.



TIP

The display position for configuration menus can be set to either the top-left or the bottom-right of the images. If you press the [Menu] button on either the remote control or the projector's control panel twice in succession when displaying a configuration menu, the configuration menu will be displayed in a different position from before. If you would like to change configuration menu settings while checking images, select an appropriate point in the projection and then display the configuration menu.

Computers and projectors can be connected together using a network so that the statuses of the projectors can be monitored and controlled by computer via the network.

A Projector Software CD-ROM is included as an accessory with this projector. The Projector Software CD-ROM contains the EMP NetworkManager and EMP Monitor software. This software can be used to carry out the following network monitoring and control functions.

- **EMP Monitor**

This allows the statuses of projectors that are connected via a network to be displayed on a computer monitor. Multiple projectors can be monitored and controlled in this way using a single computer.

- **EMP NetworkManager**

This software is used to make network settings and e-mail notification function settings for a projector using a computer. When EMP NetworkManager is used to make mail notification function settings, e-mail messages can be sent to a pre-designated e-mail address to notify the computer operator when a problem occurs with a projector.

- **Monitoring using [SNMP](#) and the SNMP manager program**

Projector status can be monitored and controlled from a computer using SNMP. To use the SNMP function to monitor the projectors, you need to install the SNMP software into the computer to be used for monitoring. This should be done by a network administrator or someone else who is familiar with the details of the network.

Carry out the following operations in the order listed in order to set up monitoring and control of projectors via a network.

1. Use the Projector Software CD-ROM to install the software to be used into the computer. [☛ p.93](#)
2. Connect the projector to the network using the a network cable. [☛ p.94](#)
3. Use the projector's configuration menus to make the required network settings. [☛ p.95](#)
4. Use the computer to monitor and control the projector.
 - Monitoring and control using EMP Monitor [☛ p.101](#)
 - Monitoring by means of the mail notification function [☛ p.96](#)

Compatible Computers

Computers that can run EMP Monitor

Operating System*	Windows 95/98 SE/Me/NT4.0/2000 Professional/XP/XP Home Edition/XP Professional
CPU	Pentium MMX 166 MHz or higher (Pentium II 233 MHz or higher recommended)
RAM	64 MB or more (128 MB or more recommended)
Free hard disk space	6 MB or more
Display	XGA (1024 × 768) resolution or higher, 16-bit colour or greater

* Macintosh computers are not supported. If using Windows 95, you must have Internet Explorer Ver. 3 or later installed.

Computers that can run EMP NetworkManager

Operating System*	Windows 98 SE/Me/NT4.0 (Service pack 6a or later)/2000 Professional/XP/XP Home Edition/XP TabletPC Edition
CPU	Pentium MMX 166 MHz or higher (Pentium II 233 MHz or higher recommended)
RAM	250 KB or more
Free hard disk space	7 MB or more (10 MB or more recommended)
Display	XGA (1024 × 768) resolution or higher, 16-bit colour or greater

* Macintosh computers are not supported.

Installing and Uninstalling the Projector Software

The EMP Monitor and EMP NetworkManager software programs can be installed separately from the accessory Projector Software CD-ROM as required.

If using Windows 2000/NT4.0/XP, installation must be carried out by a user who is logged in as Administrator.

■ Installing the software

PROCEDURE

- 1 Turn on the computer's power, start Windows, and then place the accessory Projector Software CD-ROM into the computer's CD-ROM drive.

The setup program will start up automatically and the software selection window will be displayed.



TIP

If the setup program does not start up automatically, click [Start], click [Run] to open the [Run] dialog box, type the drive letter of the CD-ROM drive followed by ":\SETUP.exe" in the [Run] box, and then click [OK].

- 2 Check that "Installing EPSON Projector Software" is selected, and then click [→].



TIP

If you click [↑], the language selection window will be displayed. You can then change the display language.

- 3 Select the software to be installed and then click [→].



Installation will then start. Follow the prompts that appear on the screen to continue the installation.



- 4 When the installation is complete, the display will return to the window that appeared in step 3. If you would like to install other software, select the required software and then click [⋮].

Once you have finished installing the software, click [⏪].

■ Uninstalling the software

To uninstall the projector software, select "Control Panel" from "My Computer", double-click "Add/Remove Programs" (or "Add or Remove Programs" if you are using Windows XP), select the programs to be uninstalled, and then click [Add/Remove] (or [Change/Remove] if you are using Windows XP).



TIP

EMP Monitor and EMP NetworkManager cannot be uninstalled simultaneously. Uninstall them one at a time.

Network Cable Connections

The projector can be connected to a network using a commercially-available 100baseTX or 10baseT network cable.

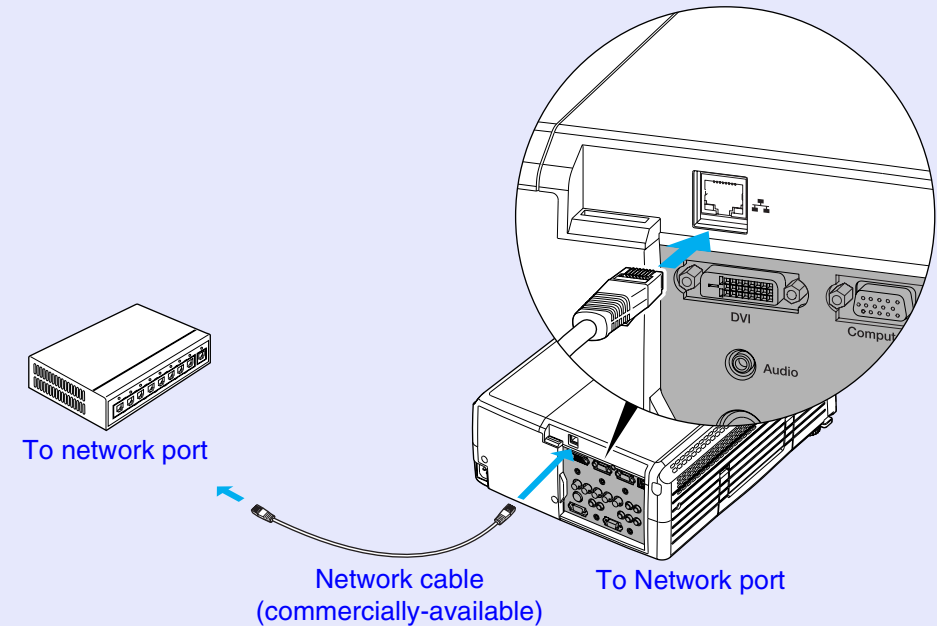

Projector Connection Settings

When the projector is connected to the network, various settings such as the [IP address](#) must be made using the configuration menus before the projector can be used.

Network connections using the configuration menus

Use the accessory remote control to carry out these operations.

PROCEDURE

1 Press the [Menu] button on the remote control and then select "Network" from the "Advanced2" menu.

Refer to "Using the Configuration Menus" (p.90) for details on using the menus.

2 Press the [Num] button on the remote control to enter numbers.

You may need to enter numbers as part of the settings for an item. If you press the [Num] button, it will light up and the remote control buttons shown right can be used as a numeric keypad.

Press the [Num] button again to cancel the numeric keypad mode.

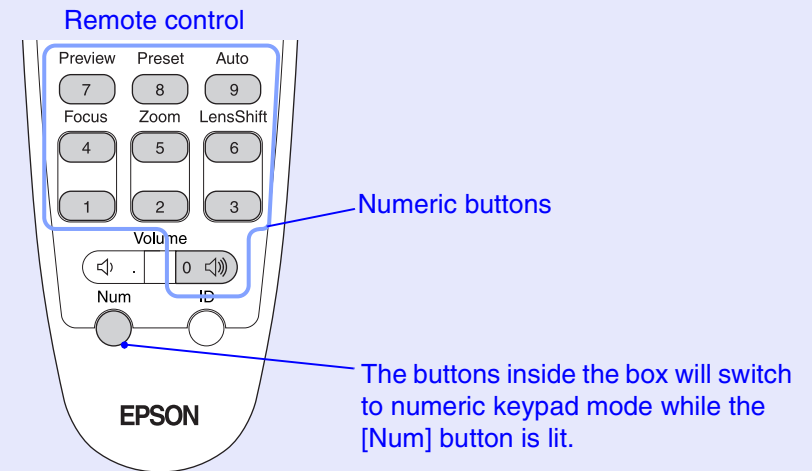

The following table shows the setting details for each item.

DHCP	Sets whether DHCP is used or not. ON: DHCP is used. OFF: DHCP is not used.
IP Address	Settings can be entered when "DHCP" is set to "OFF". Enter the IP address that has been assigned to the projector.
Subnet Mask	Settings can be entered when "DHCP" is set to "OFF". Enter the subnet mask that has been assigned to the projector.
Gateway Address	Settings can be entered when "DHCP" is set to "OFF". Enter the IP address for the gateway that has been assigned to the projector.



SNMP »	Enter the IP address to use for notification of SNMP traps. Two IP addresses can be set as notification addresses: " Trap IP Address » 1" and "Trap IP Address 2". If a notification cannot be sent to the IP address that is set for "Trap IP Address 1", then it is sent to the IP address that has been set for "Trap IP Address 2".
MAC Address »	Shows the MAC address for the projector.

- 3** Once the settings have been made, press the [Menu] button to close the configuration menu.

**TIP**

Once the projector has been connected to the network, EMP NetworkManager can be used to change the projector's network settings. [p.97](#)

Problem Reporting Using the Mail Notification Function

If EMP NetworkManager has been used to make the settings for the mail notification function, notification messages can be sent to a computer with a preset e-mail address when a problem or warning occurs with a projector connected to the network. This will notify the e-mail recipient that there is a problem with the projector.

**TIP**

- *Up to a maximum of three notification destinations (addresses) can be recorded, and notification messages can be sent to all three destinations at once.*
- *If a critical problem develops with a projector which causes it to suddenly stop working, it may not be possible for the projector to send a message notifying an operator of the problem.*
- *If "Standby Mode" in the projector's "Advanced1" menu is set to "Network ON", monitoring can be carried out even when the projector is in standby mode (when the power is off). [p.85](#)*

Check the following points before starting up EMP NetworkManager.

- EMP NetworkManager must be installed in the computer to be used for monitoring and control. [p.93](#)
- The computer and the projector must be connected to the network. [p.94](#)

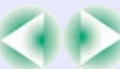

Mail Notification Settings

PROCEDURE

- 1 With Windows running, click [Start], point to [Programs] (or [All Programs]), point to [EPSON Projector] and then click [EMP NetworkManager].

EMP NetworkManager will start up.

- 2 Double-click the icon for the projector to set mail notification for.

If the name for the required projector is not displayed, refer to "Connecting Manually". [p.100](#)

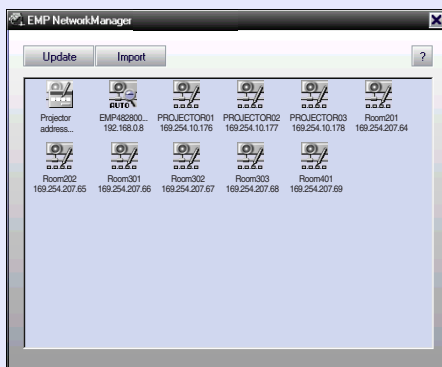

If a password has been set, the password entry dialog box will be displayed.

- 3 Connection of the projector will start, and the following Setup for Network Projector window will be displayed.

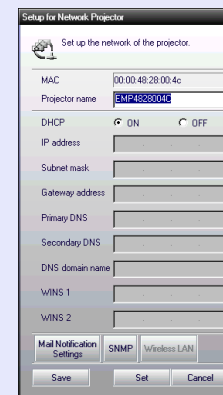

If "DHCP" is set to "OFF", the settings for the "Network" function in the "Advanced2" menu will be displayed. Make any changes that are necessary.

In addition, the "Projector name" setting that does not appear in the projector's configuration menu can be set here instead.

The Projector Name is a unique name that is used to distinguish the projector from other projectors on the network.

The name can consist of up to 15 single-byte characters.

Unicode characters, numerals and the following symbols can be used.

! @ # \$ % ^ & ' . - _ { } ~

- 4 Once the network settings for the projector have been completed, click [Mail Notification Setting] and make the settings for mail notification such as the notification destinations.

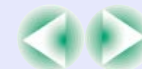

5 The following Setup of mailing functions window will be displayed.

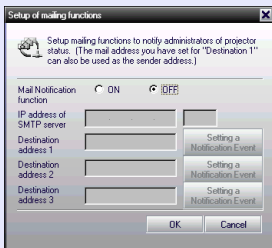

The following table shows the setting details for each item.

Mail Notification function	Sets whether the mail notification function is to be used or not. ON: The e-mail notification function is used. OFF: The e-mail notification function is not used. If this is set to "ON", the following settings can then be made.
IP address of SMTP server	Enter the IP address and the port number for the SMTP server that is to be used for sending mail. If the port number for the SMTP server has been changed, enter the port number. The default setting for the SMTP server's port number is "25". You can enter a valid value from "1" to "65535".
Destination address 1/2/3	A maximum of three e-mail address for destination computers can be recorded. Destination 1 is also used as the e-mail address for sending.
Setting a Notification Event	Use this to select the events that cause a mail notification to be sent when a problem or warning occurs with the projector. You can select one or more of the following. <ul style="list-style-type: none"> • Internal error • Fan related error. • Sensor error • Lamp timer failure • Lamp out • Lamp cover is open • Internal temperature error • High-speed cooling in progress • Lamp replacement notification • No-signal

6 Once the mail notification settings have been completed, click [OK].

7 The display will return to the Setup for Network Projector window, so click [Set].

8 When the setting finished window appears, click [OK].

9 The test message transmission checking window will be displayed.

You can send a test message to the addresses that have been set. To send a test message, click [Yes]. If you do not want to send a test message, click [No].

The subject of the test e-mail message will be "TEST MAIL". It will contain the following information.

Line 1 : Projector name

Line 2 : IP address that has been set for the projector

Line 3 : TEST MAIL (subject)

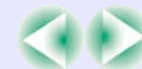

10 The settings will then be applied, and the display will return to the window that appeared in step 2. Click [X] to close EMP NetworkManager.



TIP

For security purposes it is recommended that you set a password. Right-click on the projector icon and select "Change Password" to display the Password Setup window. If setting a password for the first time, you do not need to type anything into the "Old password" field. Type in a new password that is up to 16 characters in length. Up to a maximum of 14 characters can be registered.

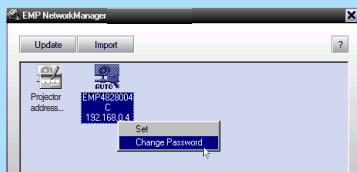

■ If a Problem Notification is Sent By Mail

If an e-mail message with "EPSON Projector" in the subject line is sent to the [IP addresses](#) that have been set as mail notification destinations, the message is a notification message saying that there is a problem with the projector.

The following information will be contained in the body of the message.
 Line 1 : The name of the projector where the problem has occurred
 Line 2 : The IP address that has been set for the projector where the problem has occurred
 Line 3 : Details of the problem

The details of the problem are listed on separate lines. The following table shows the details that are given in the message for each item.

Message*/Cause	Remedy
Internal error	"Reading the Indicators" p.109
Fan related error	
Sensor error	
Lamp cover is open	
Lamp timer failure	
Lamp out	
Internal temperature error	
High-speed cooling in progress	
Lamp replacement notification	
No-signal	

* A (+) or (-) will be appended to the start of the message.
 (+): When a projector problem has occurred
 (-): When a projector problem has been solved



Connecting Manually

If the name of the projector that you would like to set up mail notification for does not appear in the window, use the following procedure to manually connect the projector.

PROCEDURE

1 Start EMP NetworkManager.

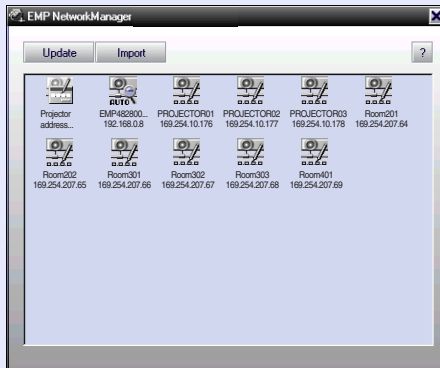

2 Double-click [Projector address selection] in the projector list display area.

3 The following IP Address Setup window will be displayed.

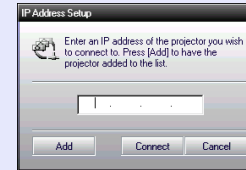

You should make the following settings when manually connecting a projector.

IP address▶▶	Enter the IP address for the projector to be connected.
[Add] button	Adds the projector with the specified IP address to the projector list display area. The window closes when this button is clicked.
[Connect] button	Connects the projector with the specified IP address to the network. The window closes when this button is clicked.
[Cancel] button	Cancel entry of the IP address.

Sharing EMP Monitor settings

A projector list that has already been recorded by EMP Monitor can also be shared by EMP NetworkManager.

PROCEDURE

1 Start EMP NetworkManager.

2 The projectors that have been recorded will be displayed in the projector list display area.

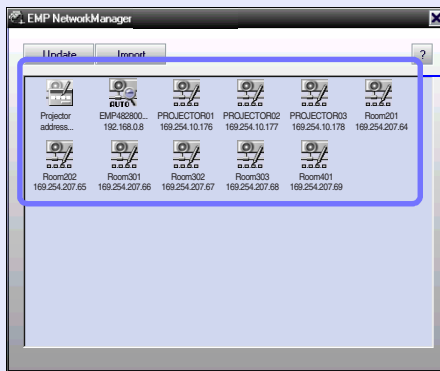

Indicates a projector that has been found using automatic search

Indicates a projector that has been registered using EMP Monitor

Indicates a projector that has been registered by specifying the [IP address](#) manually.

3 Click [Import].

The file selection window will be displayed. Select the registration file for EMP Monitor and then click [Open]. A list of the projectors that have been registered by EMP Monitor will be displayed in the projector list display area.

Centralised Monitoring and Controlling of Projectors (EMP Monitor)

EMP Monitor can be used to check the statuses of multiple projectors that are connected to the network and to carry out operations such as turning the power for the projectors on and off and changing the signal sources, all using a single computer. If there are several projectors that have been set up in different classrooms or meeting rooms, for instance, they can all be started at once and monitored by a single operator.



TIP

- A maximum of 64 projectors can be monitored and operated all at once in this way.
- If "Standby Mode" in the projector's "Advanced1" menu is set to "Network ON", EMP Monitor can be used to carry out network monitoring and control functions even when the projector is in standby mode (when the projector's power is turned off).

Check the following points before starting up EMP Monitor.

- EMP Monitor must be installed in the computer to be used for monitoring and control. [p.93](#)
- The computer and the projectors must be connected to the network.
- If using Windows 2000/NT4.0/XP, the computer must be started up by a user who is logged in as Administrator.



PROCEDURE

1 With Windows running, click [Start], point to [Programs] (or [All Programs]), point to [EPSON Projector] and then click [EMP Monitor].

EMP Monitor will start up.

2 If EMP Monitor is being started up for the first time after it was installed, or if you would like to register additional projectors, click the [Register projector] icon. If all projectors are already registered and you do not want to add any new projectors, skip to step 8.

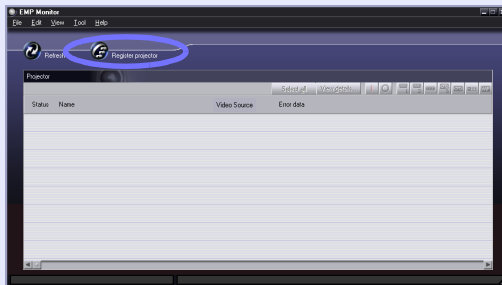

3 Click [Auto detect].

The names of all projectors that are currently connected to the network will be displayed in a list.

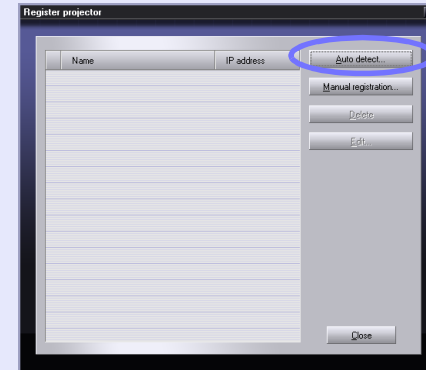

TIP

If you know the [IP address](#) of the projector that you would like to register, the Manual registration function is a handy way to register the projector. Click [Manual registration] to display the Manually register projector window. Enter the IP address and then click [Confirm]. If the Projector name appears, click [Add]. The Projector name will then be added to the list in the Register projector window.

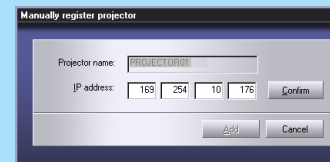

4 Select the projector to be monitored or controlled and then click [Add].

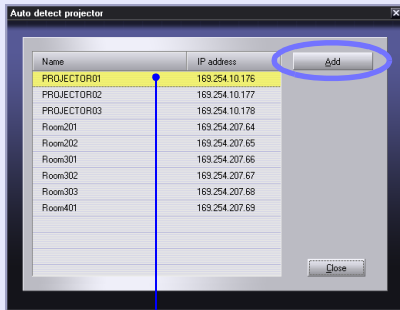

Selected projector name

5 If there are other projectors that you would like to monitor that need to be added, repeat step 4.

6 Once all new projectors to be monitored have been added, click [Close].

The display will return to the Register projector window, and the names of the added projectors will appear in the projector list.

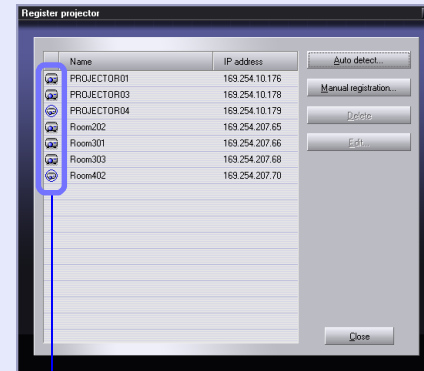

: Projectors registered using the Manual registration function

: Projectors registered using the Auto detect function

7 Once all target projectors have been registered, click [Close].

If there are any projectors in the list that you do not need to monitor, select the Projector name and then click [Delete].



TIP

*If the **IP addresses** for projectors that have been registered using the Manual registration function have changed, you can select the Projector name and then click [Edit] to change the IP address. [Edit] cannot be used for projectors that have been registered using the Auto detect function.*

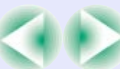

8 The statuses of the registered projectors will each be displayed.

Once a projector has been registered, the status of the projector will be displayed automatically each time EMP Monitor is started from then on.



The following table shows the display details.

Status : The projector statuses are indicated by means of the following icons.	
	Power ON with no problems
	Power OFF with no problems
	Power ON with a problem
	Power OFF with a problem
	Network error (not connected to network, power cable is not connected, etc.)
Name : Shows the name of the projector.	



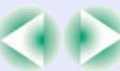





Video Source : Shows the currently selected input port.		
	Computer 1	
	Computer 2	
	BNC	
	S-Video	
	Video	
	DVI▶	
Error data : If an error occurs with the projector, the status is indicated by means of the following icons.		
	Lamp replacement notification	Replace the lamp with a new one. p.124
	High-speed cooling in progress	"Reading the Indicators" p.109
	Lamp cover open error	
	High internal temperature	
	Internal problem	
	Fan related error	
	Sensor error	



- 9** The power for all registered projectors can be turned on and off at the same time, and the input signal for all projectors can also be selected at the same time. Select the projectors for which the operation is to be carried out and then click the desired operation button.

If you would like to select all projectors, click [Select All]. Furthermore, you can also use the same operations as selecting files in Windows to select ranges of projectors; for example, click the first projector in the range, and then while pressing down the [Shift] key on the keyboard, click the last projector in the range to select all projectors within the specified range. If you hold down the [Ctrl] key, projectors can be selected and unselected each time the projector name is clicked.

The following table shows the function of each button.

[View details] button	Shows the detailed information for the selected projectors.
 Power ON	Turns the power on for the selected projectors.
 Power OFF	Turns the power off for the selected projectors.
 Computer 1	Changes the input source to the [Computer 1] port.
 Computer 2	Changes the input source to the [Computer 2] port.
 BNC	Changes the input source to the [BNC] port.
 S-Video	Changes the input source to the [S-Video] port.
 Video	Changes the input source to the [Video] port.
 DVI ▶▶	Changes the input source to the [DVI] port.

- 10** To close EMP Monitor, select [Exit] from the [File] menu, or click [x] in the top-right corner of the window.



Troubleshooting

This chapter describes how to identify problems and what to do if a problem is found.

Using the Help	107
Problem Solving	109
• Reading the Indicators	109
• When the Indicators Provide No Help	112
• Problems relating to images	113
• Problems relating to monitoring and controlling projectors using a network	118
• Other problems	119

If a problem occurs with the projector, the Help function uses on-screen displays to assist you in solving the problem. It uses a series of menus in a question and answer format.

PROCEDURE

- 1 Press the [Help] button on either the remote control or the projector's control panel.**

The help menu will be displayed.

Remote control

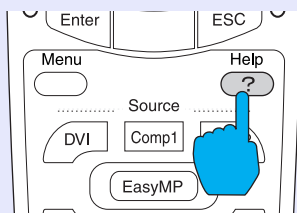

- 2 Select a menu item.**

If using the remote control, tilt the [◐] button up or down to select a menu item.

If using the projector's control panel, press the [Sync +] or [Sync -] button to select a menu item.

Remote control

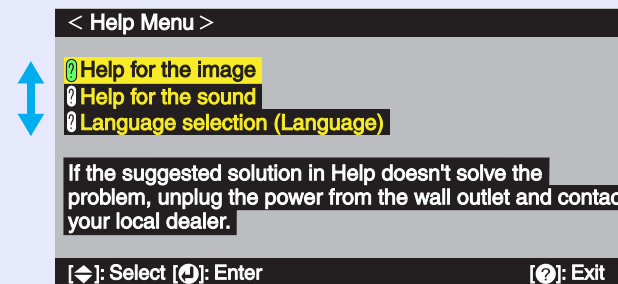
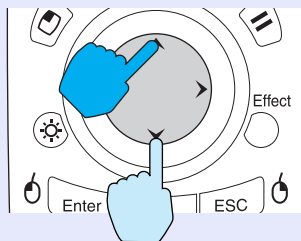

- 3 Confirm the selection.**

Press the [Enter] button on the remote control or the [Auto/Enter] button on the projector's control panel to confirm a selection.

Remote control

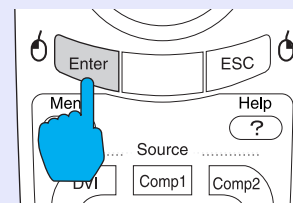

TIP

To return to a previous menu, press the [ESC] button on either the remote control or the projector's control panel.



4 Repeat steps 2 and 3 to proceed through the menu to more detailed items.

The help menu is cleared when the [Help] button is pressed.

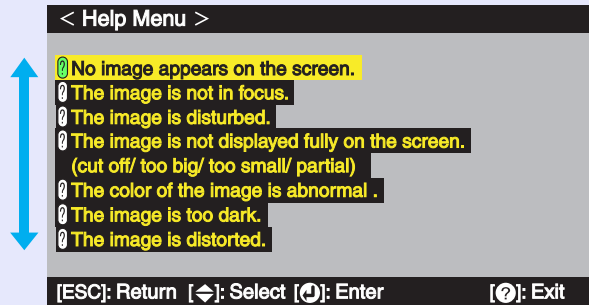

TIP

If the Help function does not provide a solution to the problem, refer to "Problem Solving".  [p.109](#)



If you are having a problem with the projector, first check the projector's indicators while referring to "Reading the Indicators" below. If the indicators do not show clearly what the problem might be, refer to "When the Indicators Provide No Help". [p.112](#)

Reading the Indicators

The projector is provided with the following three indicators. These indicators notify you of the operating status of the projector.

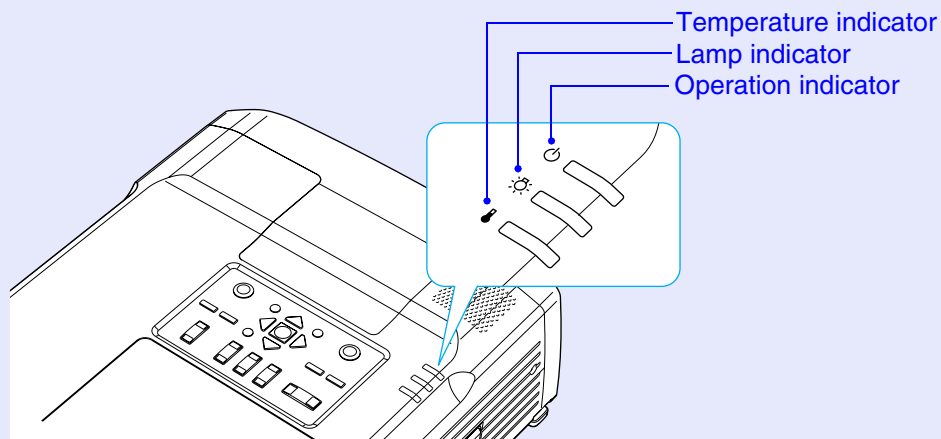

The following tables show what the indicators mean and how to remedy the problems that they indicate.

: lit : flashing : off

Status	Cause	Remedy or Status
 	Internal error	Stop using the projector, disconnect the power cable from the electrical outlet, and contact your dealer or the nearest address provided in the "International Warranty Conditions" section of the <i>Safety Instructions/World-Wide Warranty Terms</i> booklet.
 	Fan related error/Sensor error	Stop using the projector, disconnect the power cable from the electrical outlet, and contact your dealer or the nearest address provided in the "International Warranty Conditions" section of the <i>Safety Instructions/World-Wide Warranty Terms</i> booklet.



: lit : flashing : off

Status	Cause	Remedy or Status
<p> Red Red </p>	<p>Lamp cover is open error./ Lamp timer failure/ Lamp out</p>	<p>Take out the lamp and check if it is broken. Replacing the Lamp p.124 If the lamp is not broken, put it back in and then turn the power on. If the lamp still does not turn on, replace it with a new lamp. If this does not solve the problem, stop using the projector and disconnect the power cable from the electrical outlet. Then contact your dealer or the nearest address provided in the "International Warranty Conditions" section of the <i>Safety Instructions/World-Wide Warranty Terms</i> booklet.</p> <hr/> <p>If the lamp is broken. Contact your local dealer for further advice. (Projection cannot be carried out until the lamp is replaced.)</p> <hr/> <p>Check that the lamp and the lamp cover are securely installed. If the lamp or lamp cover is not securely installed, the lamp will not switch on.</p>
<p> Red Red </p>	<p>Internal temperature error (overheating)</p>	<p>The lamp will turn off automatically and projection will stop. Wait for about 5 minutes without operating the projector. After about 5 minutes have elapsed, unplug the power cable and then check the following two points.</p> <ul style="list-style-type: none"> •Check that the air filter and air exhaust vent are clear, and that the projector is not positioned against a wall. p.16 •If the air filters are blocked, clean or replace them. p.122 <p>When the power cable is plugged back in, the projector will return to its previous state, so press the [Power] button on either the projector's control panel or the remote control to turn it back on. If the projector continues to overheat even after the above points have been checked, or if the indicators show a problem when the power is turned back on, stop using the projector, disconnect the power cable from the electrical outlet, and contact your dealer or the nearest address provided in the "International Warranty Conditions" section of the <i>Safety Instructions/World-Wide Warranty Terms</i> booklet.</p>
<p> Red Orange </p>	<p>High-speed cooling in progress</p>	<p>(This is not an abnormality, However, if the temperature rises too high again, projection will stop automatically.)</p> <ul style="list-style-type: none"> •Check that the air filters and air exhaust vent are clear and that they are not up against a surface such as a wall. p.16 •If the air filters are blocked, clean or replace them. p.122
<p> Orange </p>	<p>Lamp replacement notification</p>	<p>Replace the lamp with a new one. p.124 If you continue to use the lamp after it has passed the replacement period, the possibility that the lamp may break will increase. Replace the lamp with a new one as soon as possible. * The indicator status will vary depending on the projector status at the time.</p>

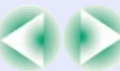

: lit : flashing : off

Status	Cause	Remedy or Status
Orange 	Standby condition	(Not abnormal) Press the [Power] button on either the remote control or the projector's control panel to start projection. When turning off the projector's power, disconnect the power plug from the electrical outlet when the projector is in this condition.
Green 	Warm-up in progress	(Not abnormal) Please wait. Warm-up time is approximately 40 seconds. After warm-up is complete, the flashing green indicator changes to steady green.
Green 	Projection in progress	(Not abnormal)
Orange 	Cool-down in progress	(Not abnormal) Please wait. <ul style="list-style-type: none"> •The cool-down period lasts about 30 seconds. (This varies depending on factors such as the ambient air temperature.) •You cannot operate the [Power] button on either the remote control or the projector's control panel during cool-down. Press the button again after cool-down ends and the indicator changes to steady orange.



TIP

- *If the projector is not operating properly even though the indicators are all showing normal, refer to "When the Indicators Provide No Help".*
- *If an indicator is showing a status which does not appear in the previous tables, contact you dealer or the nearest address provided in the "International Warranty Conditions" section of the Safety Instructions/World-Wide Warranty Terms booklet.*



When the Indicators Provide No Help

First refer to the following problems to determine what type of problem it is that you are having, and then refer to the page containing details of the problem.

Problems relating to images

- No images appear [p.113](#)
Projection does not start, the projection area is completely black, the projection area is completely blue, etc.
- Projection stops automatically [p.113](#)
- The message "Not Supported." is displayed. [p.114](#)
- The message "No Signal." is displayed. [p.114](#)
- Images are fuzzy or out of focus. [p.115](#)
- Interference or distortion appear in images. [p.115](#)
Problems such as interference, distortion or black & white checked patterns appear.
- Image is truncated (large) or small [p.116](#)
Only part of the image is displayed.
- Image colours are not right [p.117](#)
The whole image appears purplish or greenish, images are black & white, colours appear dull, etc.
(Computer monitors and LCD screens have different colour reproduction performance, so that the colours projected by the projector and the colours appearing on the monitor may not necessarily match, but this is not a sign of a problem.)
- Images are too dark or too light [p.118](#)

Problems relating to monitoring and controlling projectors using a network

- Mail notification messages are not being sent when a problem occurs with the projector. [p.118](#)
- The projector cannot be monitored and controlled using the EMP Monitor function. [p.119](#)

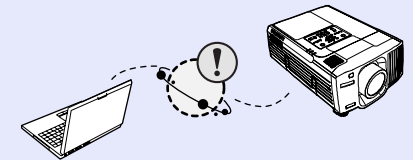

Other problems

- No sound can be heard or the sound is faint [p.119](#)
- The remote control does not work [p.120](#)

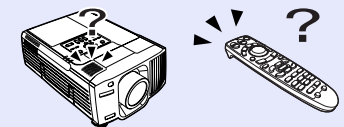

■ Problems relating to images

■ No images appear





Check	Remedy
<p>Was the [Power] button pressed?</p>	<p>Press the [Power] button on either the remote control or the projector's control panel to turn the power on. The remote control cannot be used unless the [R/C] switch of the remote control is at "ON". ☞ p.37</p>
<p>Is the A/V Mute function active?</p>	<p>Press the [A/V Mute] button on either the remote control or the projector's control panel to cancel the A/V Mute function. ☞ p.58</p>
<p>Has "No-Signal Msg." been set to "OFF"?</p>	<p>If the "No-Signal Msg." menu command has been set to "OFF", set it to "Black" or "Blue" for messages to be displayed. If a message is displayed, refer to the item indicated. "Setting" - "No-Signal Msg." ☞ p.80</p>
<p>Have the configuration menu settings been made correctly?</p>	<p>Reset all of the settings. ☞ p.89</p>
<p>Is the projected image completely black? Only when projecting computer images</p>	<p>Some input images, such as screen savers, may be completely black.</p>
<p>Are the image signal format settings correct? Only when projecting images from a video source</p>	<p>If a composite video or S-Video source is connected to the projector, use the "Video Signal" menu command to select the signal format. "Video" - "Video Signal" ☞ p.77</p>

■ Projection stops automatically





Check	Remedy
<p>Is "Sleep Mode" set to "ON"?</p>	<p>When the "Sleep Mode" menu command has been set to "ON", the lamp turns off automatically if no operations are carried out for about 30 minutes while no video signal is being input. The ⏻ indicator lights orange at this time. Press the [Power] button on either the remote control or the projector's control panel to turn the power on. If you do not want sleep mode to be used, change the "Sleep Mode" setting to "OFF". "Setting" - "Sleep Mode" ☞ p.81</p>



- The message "Not Supported." is displayed.

Check	Remedy
<p>Are the image signal format settings correct?</p> <p>Only when projecting computer images</p>	<p>If the signal from the video source which is connected to the [BNC] ports of the projector is being projected, use the "BNC Input" menu command to select the signal format which matches the connected signal source. "Setting" - "BNC Input"  p.81 If a composite video or S-Video source is connected to the projector, use the "Video Signal" menu command to select the signal format. "Video" - "Video Signal"  p.77</p>
<p>Does the mode match the frequency and resolution of the image signals?</p> <p>Only when projecting computer images</p>	<p>Use the "Frequency" menu command to check the signals being input. "About" - "Frequency"  p.88 Check the frequency and resolution of the computer.  Computer documentation</p>

- The message "No Signal." is displayed.

Check	Remedy
<p>Are the cables connected correctly?</p>	<p>Check that all of the cables required for projection are securely connected.  p.18–p.28</p>
<p>Has the correct video input port been selected?</p>	<p>Press the [Source] button on either the remote control or the projector's control panel to change the image source.  p.38</p>
<p>Is the power for the computer or video source turned on?</p>	<p>Turn the power on for the devices.  p.37</p>
<p>Are the image signals being output to the projector?</p> <p>Only when projecting images from a laptop computer or computer with a built-in LCD screen</p>	<p>If the image signals are only being output to the computer's LCD monitor or to the accessory monitor, you need to change the output to an external destination as well as the computer's own monitor. For some computer models, when the image signals are output externally, they no longer appear on the LCD monitor or accessory monitor.  Computer documentation, under a title such as "External output" or "Connecting an external monitor" If the connection is made while the power is already turned on, the function [Fn] key that switches the computer's video signal to external output may not work. Turn the power for the projector and the computer off and then back on again.  p.37, p.41</p>

■ Images are fuzzy or out of focus.





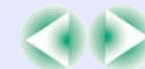

Check	Remedy
Has the focus been adjusted correctly?	Press the [Focus] button on either the remote control or the projector's control panel to adjust the focus. ☛ p.44
Is the lens cover still attached?	Remove the lens cover. ☛ p.36
Is the keystone adjustment value too large?	Use the lens shift function to adjust the position of the projection area to match the screen, or decrease the projection angle and reduce the amount of keystone correction. ☛ p.45, p.47
Has condensation formed on the lens?	If the projector is suddenly taken from a cold environment to a warm environment or if sudden ambient temperature changes occur, condensation may form on the surface of the lens, and this may cause the images to appear fuzzy. Set the projector up in the room approximately one hour before it is to be used. If condensation forms on the lens, turn the power off and wait for the condensation to disappear.

■ Interference or distortion appear in images.

Check	Remedy
Are the image signal format settings correct?	If a video source is connected to the [BNC] ports of the projector, use the "BNC Input" menu command to select the signal format which matches the connected signal source. "Setting" - "BNC Input" ☛ p.81 If a composite video or S-Video source is connected to the projector, use the "Video Signal" menu command to select the signal format. "Video" - "Video Signal" ☛ p.77
Are the cables connected correctly?	Check that all of the cables required for projection are securely connected. ☛ p.18–p.28
Is an extension cable being used?	If an extension cable is used, electrical interference may affect the signals. Use the accessory cables and check if this helps.
Has the correct resolution been selected? Only when projecting computer images	Set the computer so that the signals that are output are compatible with this projector. "List of Supported Monitor Displays" ☛ p.140 ☛ Computer documentation
Have the "Sync.▶" and "Tracking▶" settings been adjusted correctly? Only when projecting computer images	Press the [Auto] button on the remote control or the [Auto/Enter] button on the projector's control panel to carry out automatic adjustment. If the images have not been adjusted correctly after using automatic adjustment, you can make the adjustments using the "Sync." and "Tracking" menus. ☛ p.53, p.54







■ Image is truncated (large) or small

Check	Remedy
<p>Is the image in real display? Is the aspect ratio setting correct?</p>	<p>Press the [Resize] button on either the remote control or the projector's control panel.  p.67</p>
<p>Is the image still being enlarged by the E-Zoom function?</p>	<p>Press the [ESC] button on the remote control to cancel the E-Zoom function.  p.59</p>
<p>Has the "Position" setting been adjusted correctly?</p>	<p>If analogue RGB computer signals are being input, press the [Auto] button on the remote control or the [Auto/Enter] button on the projector's control panel to automatically adjust the setting. If the images have not been correctly adjusted after using the automatic setup function, adjust the setting manually using the "Position" menu command. If signals other than analogue RGB computer signals are being input, adjust the setting manually using the "Position" menu command. "Video" - "Position"  p.73, p.76</p>
<p>Has the computer been set for dual display? Only when projecting computer images</p>	<p>If dual display has been activated in the Display Properties of the computer's Control Panel, the projector will only project about half of the image on the computer screen. To display the whole of the image on the computer screen, turn off the dual display setting.  Computer video driver documentation</p>
<p>Has the "Resolution" command been set correctly? Only when projecting computer images</p>	<p>Set the "Resolution" menu command to match the computer. "Video" - "Resolution"  p.74  Computer documentation</p>

■ Image colours are not right





Check	Remedy
<p>Do the input signal settings match the signals from the connected device?</p>	<p>If the "BNC Input" menu command has been set to "YCbCr" or "YPbPr" when a computer or RGB video source is connected to the [BNC] ports of the projector, the images will appear purplish. If the "BNC Input" menu command has been set to "Analog-RGB" when a component video signal source is connected to the [BNC] ports of the projector, the images will appear greenish. Select the correct signal format for the connected source. "Setting" - "BNC Input" p.81 If a composite video or S-Video source is connected to the projector, use the "Video Signal" menu command to select the video signal format. "Video" - "Video Signal" p.77</p>
<p>Has the image brightness been adjusted correctly?</p>	<p>Use the "Brightness" menu command to adjust the brightness. "Video" - "Brightness" p.73, p.76</p>
<p>Are the cables connected correctly?</p>	<p>Check that all of the cables required for projection are securely connected. p.18–p.28</p>
<p>Has the image contrast been adjusted correctly?</p>	<p>Use the "Contrast" menu command to adjust the contrast. "Video" - "Contrast" p.73, p.76</p>
<p>Has the colour been adjusted correctly?</p>	<p>Use the "Color Adjustment" menu command to adjust the colour. "Advanced1" - "Color Adjustment" p.84</p>
<p>Have the colour intensity and tint been adjusted correctly?</p> <p>Only when projecting images from a video source</p>	<p>Use the "Color" and "Tint" menu commands to adjust the colour and tint. "Video" - "Color", "Tint" p.76</p>

■ Images are too dark or too light

Check	Remedy
Have the image brightness and luminance been adjusted correctly?	Use the "Brightness" and "Brightness Control" menu commands to adjust the brightness and luminance. "Video" - "Brightness"  p.73, p.76 "Advanced2" - "Brightness Control"  p.86
Has the image contrast been adjusted correctly?	Use the "Contrast" menu command to adjust the contrast. "Video" - "Contrast"  p.73, p.76
Is the lamp due for replacement?	When the lamp is nearly due for replacement, the images will become darker and the colour quality will become poorer. When this happens, the lamp should be replaced with a new one.  p.124

■ Problems relating to monitoring and controlling projectors using a network

■ Mail notification messages are not being sent when a problem occurs with the projector.

Check	Remedy
Is the projector computer correctly connected to the network?	Connect the network cable correctly.  p.94
Has the projector been set up correctly for connection to the network?	Check the settings for the "Network" menu command. "Advanced2" - "Network"  p.95
Has the destination e-mail address been set correctly?	Send a test message and check if it arrives.  p.98
Has "Standby Mode" been set to "Network ON"?	If using the mail notification function while the projector is in standby mode, change the "Standby Mode" menu setting to "Network ON". "Advanced1" - "Standby Mode"  p.85
Has a critical problem developed causing the projector to momentarily stop working?	When the projector has momentarily stopped working, it cannot send e-mail messages. If the projector cannot be reset even after it has been checked, contact your dealer or the nearest address provided in the "International Warranty Conditions" section of the <i>Safety Instructions/World-Wide Warranty Terms</i> booklet.
Is power being supplied to the projector?	Check if the power supply to the location where the projector is set up has been interrupted, or if the circuit breaker for the electrical outlet that the projector is connected to has been tripped.

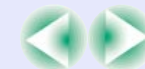

- The projector cannot be monitored and controlled using the EMP Monitor function.

Check	Remedy
Is the projector computer correctly connected to the network?	Connect the network cable correctly. ☞ p.94
Has the projector been set up correctly for connection to the network?	Check the settings for the "Network" menu command. "Advanced2" - "Network" ☞ p.95
Has EMP Monitor function been correctly installed to the computer?	Uninstall EMP Monitor and then re-install it. ☞ p.93, p.94
Have all projectors that are to be monitored and controlled been registered in the projector list?	Register the projector in the projector list. ☞ p.101
Has "Standby Mode" been set to "Network ON"?	If using the EMP Monitor function while the projector is in standby mode, change the "Standby Mode" menu setting to "Network ON". "Advanced1" - "Standby Mode" ☞ p.85
Is power being supplied to the projector?	Check if the power supply to the location where the projector is set up has been interrupted, or if the circuit breaker for the electrical outlet that the projector is connected to has been tripped.

■ Other problems

- No sound can be heard or the sound is faint

Check	Remedy
Is the audio source connected correctly?	Check that the cable is connected to the correct "Audio" port. ☞ p.29
Has the volume been adjusted to the minimum setting?	Adjust the volume so that sound can be heard. "Audio" - "Volume" ☞ p.56
Is an audio cable still connected to the projector's [Audio Out] port?	If a cable connector is inserted into the [Audio Out] port, sound is no longer output from the projector's built-in speaker. If not using external speakers, disconnect the audio cable from the [Audio Out] port.
Is the A/V Mute function active?	Press the [A/V Mute] button on either the remote control or the projector's control panel to cancel the A/V Mute function. ☞ p.58

■ The remote control does not work

Check	Remedy
Is the [R/C] switch at the "ON" position?	Set the [R/C] switch to the "ON" position. ☞ p.37
Is the remote control light-emitting area facing towards the remote control light-receiving area when it is operated?	Face the remote control towards the remote control light-receiving area. The operating angle for the remote control is approximately $\pm 30^\circ$ horizontally and approximately $\pm 15^\circ$ vertically. ☞ p.14
Is the remote control too far from the projector?	The operating range for the remote control is approximately 10 m. ☞ p.14 If operating the remote control from a distance or if you would like to ensure that remote control operations work properly, use the optional remote control cable kit. ☞ p.132
Is direct sunlight or strong light from fluorescent lamps shining onto the remote control light-receiving area?	Set the projector up in a location where strong light will not shine onto the remote control light-receiving area.
Are the batteries dead, or have the batteries been inserted correctly?	Insert new batteries, while making sure that they face correctly. ☞ p.12
Does the remote control's ID number match the projector's ID number?	If the remote control's ID number is set to a number other than "0", the ID number must match the projector's ID number, otherwise the remote control will not work. ☞ p.69
Is the remote control cable still connected to the [Remote] port of either the remote control or the projector?	If the remote control cable is still connected to the [Remote] port, the remote control light-receiving areas of the projector or the remote control light-emitting area of the remote control will not work. If not using the remote control cable kit, disconnect the remote control cable from the [Remote] port of either the remote control or the projector.



Appendices

This chapter provides information on maintenance procedures to ensure the best level of performance for the projector for a long time.

Maintenance	122	List of ESC/VP21 Commands.....	137
• Cleaning	122	• Command List	137
• Cleaning the Projector Case.....	122	• Communication Protocol	137
• Cleaning the Lens	122	• Cable Layouts	138
• Cleaning the Air Filters and Air Intake Vent	122	• Serial connection	138
• Replacing Consumables.....	123	• USB connection.....	138
• Lamp Replacement Period.....	123	• USB Connection Setup	139
• Replacing the Lamp.....	124	List of Supported Monitor Displays	140
• Resetting the Lamp Operating Time.....	126	• Computer/RGB Video	140
• Replacing the Air Filters.....	127	• Component Video.....	140
Saving a User's Logo	129	• Composite Video/S-Video	140
Optional Accessories	132	Specifications	141
Glossary	134	Appearance.....	143
		Index	144

This section describes maintenance tasks such as cleaning the projector and replacing consumable parts.

Cleaning

You should clean the projector if it becomes dirty or if the quality of projected images starts to deteriorate.



CAUTION

Be sure to read the separate Safety Instructions/World-Wide Warranty Terms before cleaning.

Cleaning the Projector Case

Clean the projector case by wiping it gently with a soft cloth. If the projector is particularly dirty, moisten the cloth with water containing a small amount of neutral detergent, and then firmly wring the cloth dry before using it to wipe the projector case. Then wipe the case again with a soft, dry cloth.



CAUTION

Do not use volatile substances such as wax, alcohol or thinner to clean the projector case. These can cause the case to warp and make the coating finish peel off.

Cleaning the Lens

Use a commercially-available air blower, or use lens cleaning paper to clean the lens.



CAUTION

Do not rub the lens with harsh materials or subject the lens to shocks, as it can easily become damaged.

Cleaning the Air Filters and Air Intake Vent

If the air filters become clogged with dust, or if the message "The projector is overheated. Clean or replace the air filter and lower the room temperature." appears on the screen, clean the air filters and the air intake vent.

If the air filters become clogged with dust, it can cause overheating and damage the projector.

- Air filter in base of projector

Stand the projector up and use a vacuum cleaner to clean the air filter.

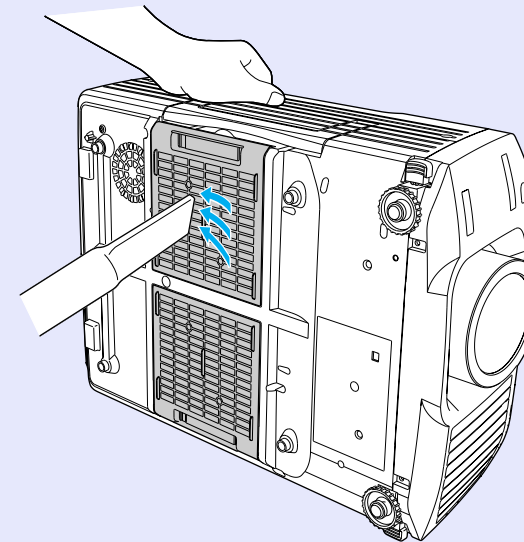

- Air intake vent in side of projector
Place the projector flat and use a vacuum cleaner to clean the air intake vent.

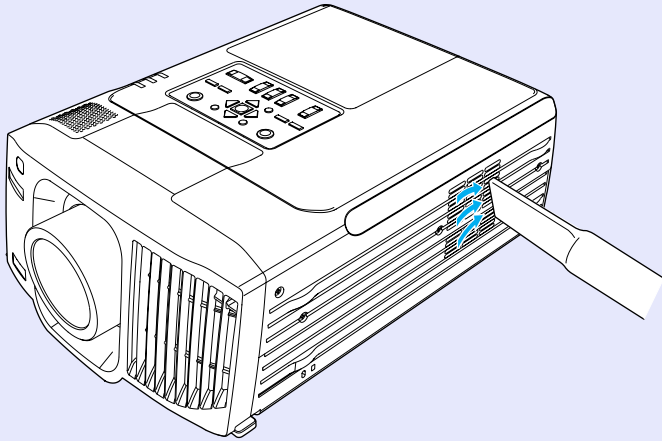

TIP

- *If the air filters are broken or if the warning message reappears after they have been cleaned, they should be replaced. Replace them with new air filters. See "Appendices: Optional Accessories" p.132*
- *Spare lamps are provided with spare air filters. The air filters should also be replaced when the lamp is replaced.*

Replacing Consumables

This section describes how to replace the lamp and the air filters.

Lamp Replacement Period

It is time to replace the lamp when:

- The message "Lamp Replace." appears on the screen when projection starts

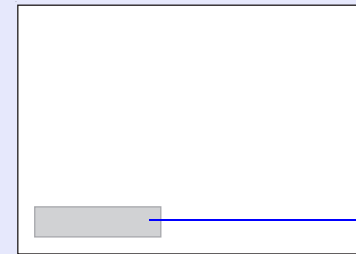

A message will be displayed.

- The  indicator is flashing orange

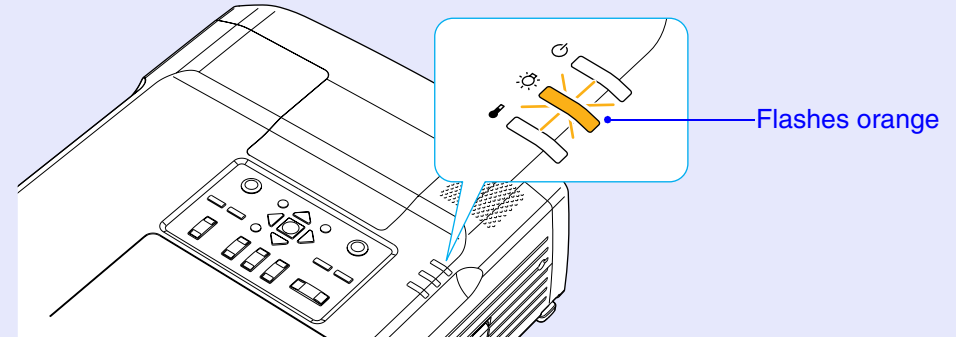

Flashes orange

- The projected images get darker or start to deteriorate in quality.



TIP

- *The replacement warning message is set to appear after about 1900 hours of lamp use in order to maintain the initial brightness and quality of the projected images. If you continue to use the lamp after this period, the possibility of the lamp breaking becomes greater. When the lamp replacement message appears, replace the lamp with a new one as soon as possible, even if it is still working.*
- *The warning message appears after about 1900 hours of use, but the actual life of each individual lamp will vary depending on the characteristics of the lamp and on the way it has been used, and some lamps may stop operating before 1900 hours of use. You should always have a spare lamp ready in case it is needed.*
- *Contact your dealer for a spare lamp.*

Replacing the Lamp



CAUTION

- *If you are replacing the lamp because it has stopped working, it is possible that the lamp is broken. If replacing the lamp of a projector which has been installed to the ceiling, you should always assume that the lamp is broken and be extremely careful when removing the lamp cover.*
- *Wait until the lamp has cooled down sufficiently before removing the lamp cover. It takes a further one hour after the [cool-down](#) period has finished for the lamp to be cool enough.*

PROCEDURE

1

Turn the projector's power off, wait for the cool-down period to end, and then disconnect the power cable.

The cool-down period lasts for about 30 seconds.

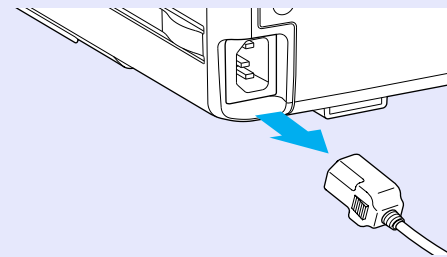

TIP

If the projector has been installed on the ceiling and the cable cover has been attached, remove the cable cover before proceeding. [p.34](#)

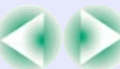

2 Wait until the lamp has cooled down, and then remove the lamp cover from the base of the projector.

It takes a further one hour after the cool-down period has finished for the lamp to be cool enough.

Use the screwdriver that is supplied with the spare lamp or some other Phillips screwdriver to remove the two lamp cover fixing screws. Be careful not to let the lamp cover fall down after the fixing screws have been removed.

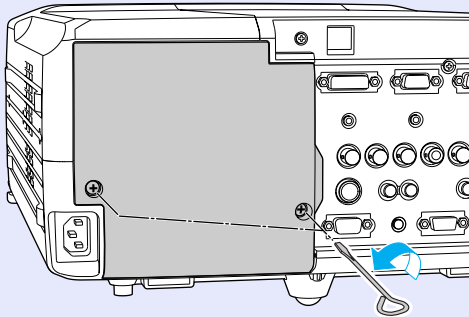

3 Loosen the three lamp fixing screws.

Use the screwdriver that is supplied with the spare lamp or some other Phillips screwdriver to loosen the three lamp fixing screws that are securing the lamp to the projector.

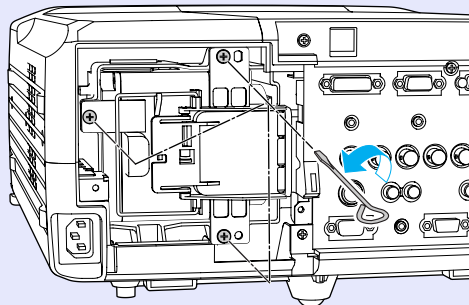

4 Take out the old lamp.

Fold out the handle as shown in the illustration below and pull the lamp straight out of the projector while supporting it with one hand so that it does not drop.

If the lamp is broken, replace it with a new lamp, or contact your local dealer for further advice. If replacing the lamp yourself, be careful to avoid pieces of broken glass.

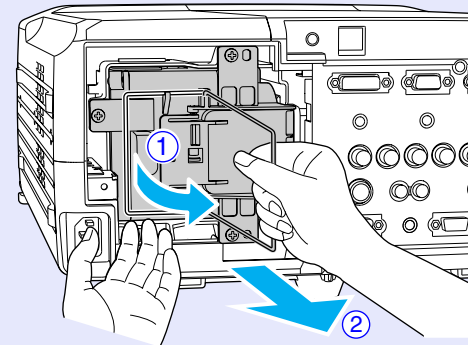

5 Install the new lamp.

Hold the lamp so that it faces the correct way to fit into the projector, insert the lamp until it clicks into place, and then fold down the handle and secure it by engaging the tab.

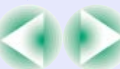
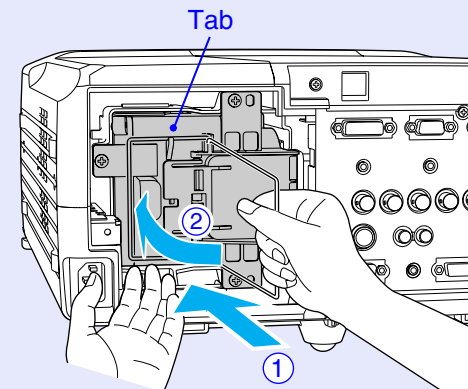

6 Tighten the three lamp fixing screws.

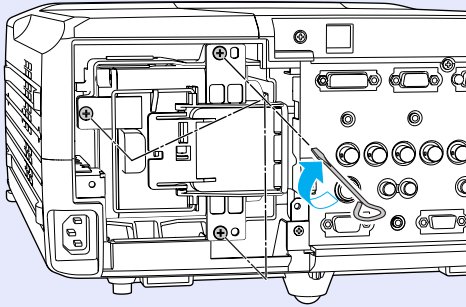

7 Install the lamp cover.

Insert the cover tab at the top of the lamp cover into the projector, and then install the lamp cover and tighten the two lamp cover fixing screws.

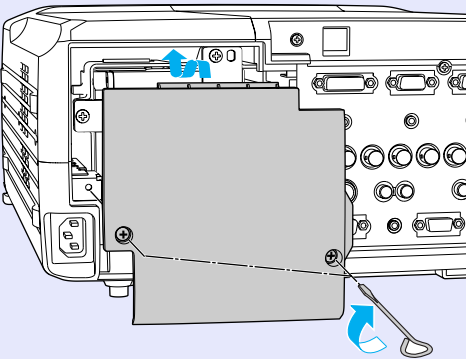

TIP

- *Install the lamp securely. If the lamp cover is removed, the lamp turns off automatically as a safety precaution. Moreover, the lamp will not turn on if the lamp or the lamp cover is not installed correctly.*
- *Spare lamps are provided with spare air filters. The air filters should also be replaced when the lamp is replaced. [p.127](#)*
- *Dispose of used lamps properly in accordance with your local regulations.*

Resetting the Lamp Operating Time

The projector has a built-in counter which keeps track of the lamp operating time, so that when the cumulative operating time reaches a certain point, it causes the replacement warning message to be displayed. Therefore, the counter needs to be reset using the configuration menu after the lamp has been replaced with a new one.



TIP

Do not reset the lamp operating time except after the lamp has been replaced. If the lamp operating time is reset at any other time, the lamp replacement period will not be indicated correctly.

PROCEDURE

- 1 Connect the power cable, turn on the projector's power, and then press the [Menu] button on the remote control.

The configuration menu will be displayed.

Remote control

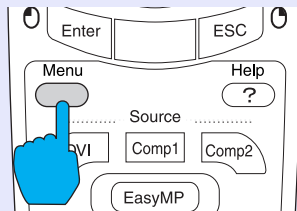

- 2 Select "Reset Lamp Timer" from the "About" menu and then press the [Enter] button on the remote control or the [Auto/Enter] button on the projector's control panel.

Lamp	: 1900H
Reset Lamp Timer	↵ → Execute
Source	: Computer1
Input Signal	: Analog-RGB
Frequency	: H ---.--kHz
	: V ---.--Hz
SYNC Polarity	: H -----
	: V -----
SYNC Mode	: -----
Resolution	: 0x 0
Refresh Rate	: 0.0 Hz

- 3 Select "Yes" and then press the [Enter] button on the remote control or the [Auto/Enter] button on the projector's control panel.

The lamp operating time will then be reset.

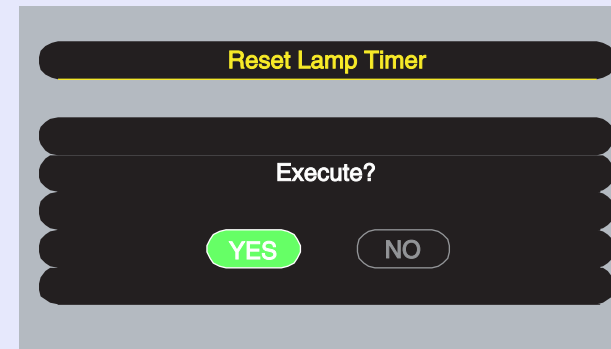

Replacing the Air Filters

The air filters can be replaced even if the projector is installed on a ceiling.

PROCEDURE

- 1 Turn the projector's power off, wait for the [cool-down](#) period to end, and then disconnect the power cable.

The cool-down period lasts for about 30 seconds.

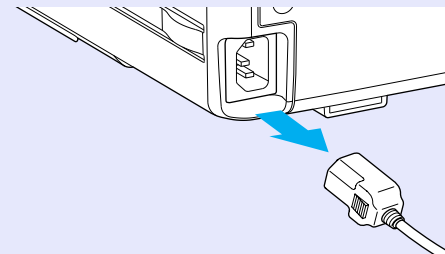

- 2** Put your finger into the recess of an air filter cover, and slide the air filter cover to the outside to remove it.

The projector has two air filter covers.

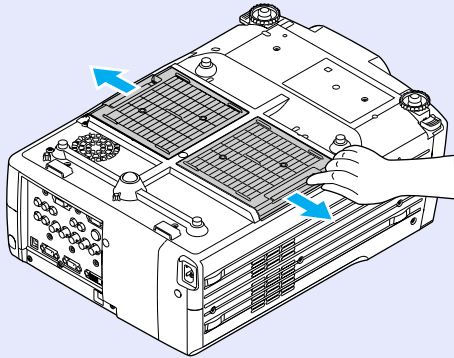

- 3** Remove the old air filter that is in the air filter cover.

Insert the screwdriver that is supplied with the spare lamp or some other flat-tipped screwdriver into the space between the air filter and the air filter cover as shown in the illustration below, and push it backwards to remove the air filter.

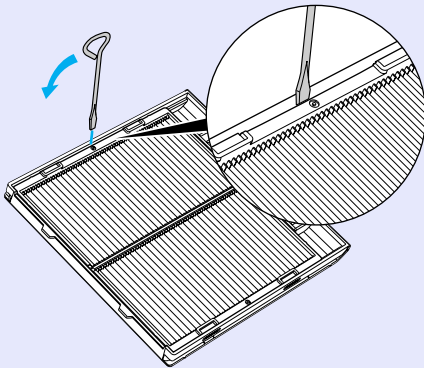

- 4** Install new air filters into the air filter covers.

Insert one of the tabs on an air filter into the air filter cover, and then press down on the other tab until it clicks into place.

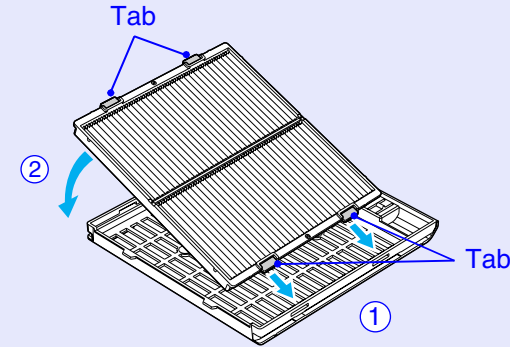

- 5** After replacing the two air filters, install the air filter covers.

Slide the air filter covers in from the outside and push them in until they click into place.

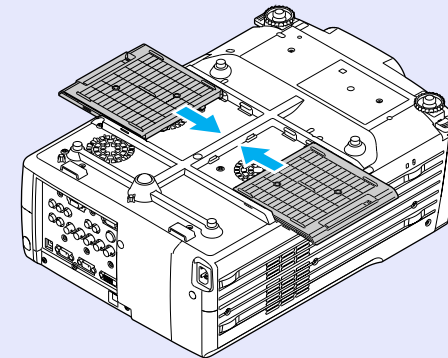
**TIP**

Dispose of used air filters properly in accordance with your local regulations.

You can record the image that is currently being projected as a user's logo.

**TIP**

When a user's logo is recorded, the previous user's logo will be erased.

PROCEDURE

1 Project the image that you would like to use as a user's logo, and then press the [Menu] button on either the remote control or the projector's control panel.

2 Select the "User's Logo" menu, and then press the [Enter] button on the remote control or the [Auto/Enter] button on the projector's control panel.

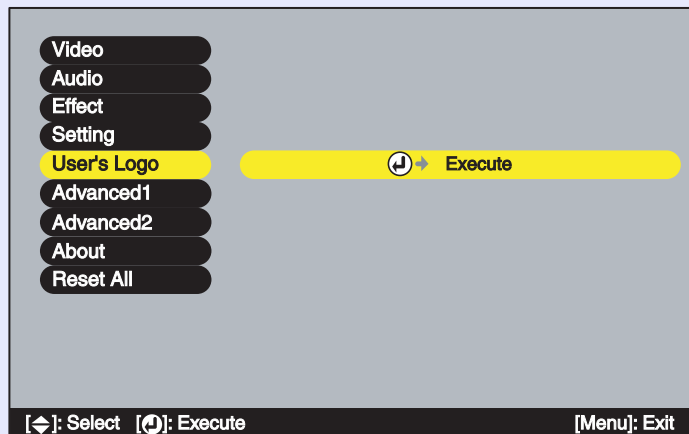
**TIP**

If keystone correction or the E-Zoom function have been used, they will be cancelled when the "User's Logo" menu is selected.

3

Select "Yes" in the sub-menu, and then press the [Enter] button on the remote control or the [Auto/Enter] button on the projector's control panel.

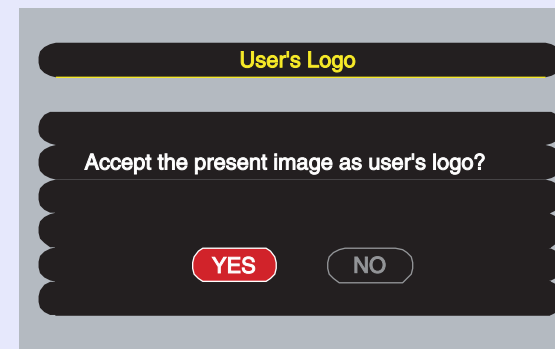
**TIP**

When you press the [Enter] button on the remote control or the [Auto/Enter] button on the projector's control panel, the images will be projected at their original image signal resolution, so that when you are projecting images which have a resolution that is different from the number of pixels on the projector's panel, and when you are projecting video images, the display size will change.



- 4** The image to be recorded and a selection marquee box will be displayed, so move the marquee box to select the part of the image to use.

Tilt the [○] button on the remote control or press the [Sync +], [Sync -], [Tracking +] and [Tracking -] buttons on the projector's control panel to select the part of the image to use as the user's logo, and then press the [Enter] button on the remote control or the [Auto/Enter] button on the projector's control panel.

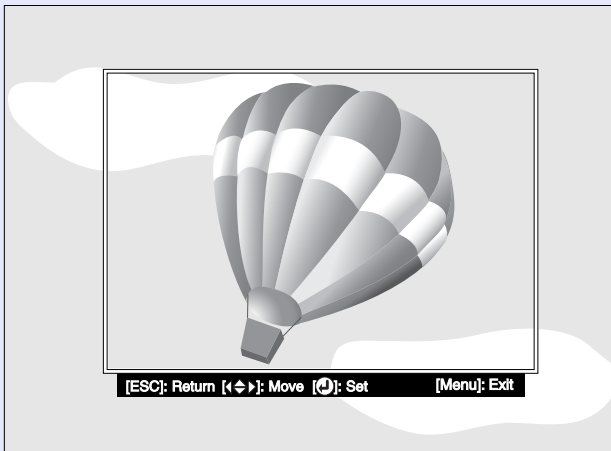
**TIP**

User's logos can be saved at up to 480 × 360 dots in size.

- 5** Select "Yes" at the confirmation screen, and then press the [Enter] button on the remote control or the [Auto/Enter] button on the projector's control panel.

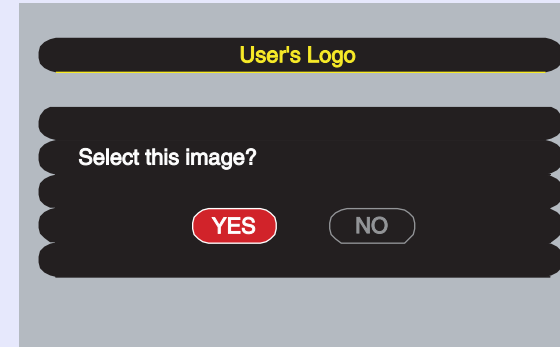

- 6** Select the zoom rate in the Zoom rate setting screen, and then press the [Enter] button on the remote control or the [Auto/Enter] button on the projector's control panel.

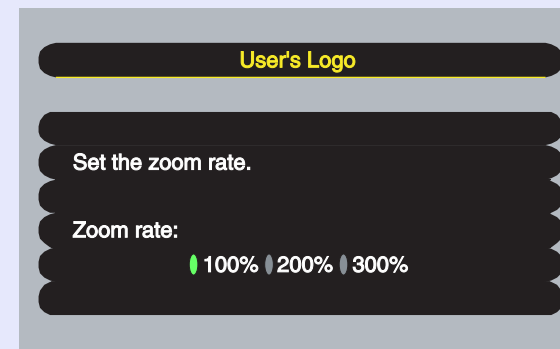

- 7** Select "Yes" at the confirmation screen, and then press the [Enter] button on the remote control or the [Auto/Enter] button on the projector's control panel.

The image will then be saved. Once the image has been saved, the message "Completed." will be displayed.

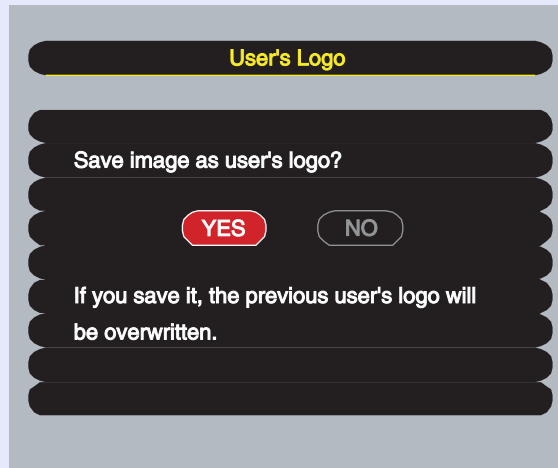
**TIP**

- *Saving the user's logo may take a few moments (about 15 seconds). Do not use the projector or any other sources which are connected to the projector while the user's logo is being saved. If this is not observed, it may result in errors in projector operation.*
- *Once a user's logo has been saved, the logo setting cannot be returned to the factory default.*



The following optional accessories are available for purchase if required. This list of optional accessories is current as of March 2003. Details of accessories are subject to change without notice.

Hard travel case ELPKS50

Use this case if you need to carry the projector by hand.

Spare lamp ELPLP23

(Set with spare lamp and two spare air filters)

Use as a replacement for spent lamps.

Filter kit (3 sets of 2 air filters (total 6)) ELPAF02

Use as a replacement for spent air filters.

40" "Billboard Vision" screen ELPHS01

60" "Billboard Vision" screen ELPHS03

A translucent-type screen. ([Aspect ratio](#)▶4:3)

60" screen ELPSC07

80" screen ELPSC08

100" screen ELPSC10

A portable roll-type screens. (Aspect ratio 4:3)

50" portable screen ELPSC06

A compact screen which can be carried easily. (Aspect ratio 4:3)

VGA-HD15 PC cable ELPKC02

(1.8 m (6 ft.) - for mini D-Sub 15-pin/mini D-Sub 15-pin)

This is the same computer cable as the projector's accessory computer cable.

VGA-HD15 PC cable ELPKC09

(3 m (9.8 ft.) - for mini D-Sub 15-pin/mini D-Sub 15-pin)

VGA-HD15 PC cable ELPKC10

(20 m (65.6 ft.) - for mini D-Sub 15-pin/mini D-Sub 15-pin)

Use these extension cables if the accessory computer cable is too short.

VGA-HD15/BNC PC cable ELPKC11

(1.8 m (6 ft.) - for mini D-Sub 15-pin/5BNC)

Use in order to connect the projector to a computer with a 5BNC port.

Digital video cable DVI-D/DVI-D ELPKC20

(3 m (9.8 ft.) - for DVI-D male/male)

This is a [DVI](#)▶ cable for connecting the projector to a computer with a digital RGB output interface.

Digital video cable DVI-D/DFP ELPKC21

(3 m (9.8 ft.) - for DVI-D/DFP 20-pin)

This is a [DFP](#)▶ cable for connecting the projector to a computer with a digital RGB output interface.

Remote control cable set ELPKC28

(10 m - for 3.5 mm dia. mini plug (male-male))

(10 m - for 3.5 mm dia. mini jack (male-female))

Use in order to operate the projector accurately by remote control from a distance.

Image presentation camera ELPDC02

ELPDC03

ELPDC04

Use to project books, OHP films and slides.



Standard lens^{*1} ELPLS02

(Projection distance ratio: Approx. 1.8–2.4)

Rear projection wide lens^{*1} ELPLR02

(Projection distance ratio: Approx. 0.86)

Long throw zoom lens^{*1} ELPLL04

(Projection distance ratio: Approx. 5.3–7.1)

Medium throw zoom lens 1^{*1} ELPLM01

(Projection distance ratio: Approx. 2.4–3.6)

Medium throw zoom lens 2^{*1} ELPLM02

(Projection distance ratio: Approx. 3.6–5.3)

Wide angle zoom lens^{*1} ELPLW02

(Projection distance ratio: Approx. 1.3–1.8)

Projection distance ratio = Projection distance/Width of projection area
The values should be used as a guide for setting up. The value will vary depending on setup conditions and the zoom setting.

Easy Mp.net unit^{*1} ELPXP01

Useful for a variety of presentations utilising a network.

*1 cannot be installed by the customer. Please contact your dealer for assistance.

Ceiling plate^{*2} ELPFC03

Pipe 370 (370 mm (14.57 in.)/silver)^{*2} ELPFP04

Pipe 570 (570 mm (22.44 in.)/silver)^{*2} ELPFP05

Pipe 770 (770 mm (30.31 in.)/silver)^{*2} ELPFP06

Dual stacker^{*2} ELPMB15

Stacker plus^{*2} ELPMB16

Ceiling bracket^{*2} ELPFC02

Use when installing the projector on a high ceiling or a ceiling with veneer panels.

Ceiling mount ELPMB14

Use when installing the projector on a ceiling.

*2 A special method of installation is required in order to suspend the projector from the ceiling. Please contact your supplier if you would like to use this installation method.



The following table contains explanations of some of the terms used in this guide which may be unfamiliar or which are not explained in the text of the guide. Further information can be obtained by referring to other commercially-available publications.

3-2 pull-down function	This function directly converts image sources that have been recorded in the same 24-frame format used for movies into 60-frame progressive signals. This allows data such as DVD software that has been recorded in 24-frame format to be played back on large screens with more natural and accurate reproduction, without any loss of image quality from the original movie.
5BNC	A port used to input analogue video signals.
Aspect ratio	The ratio between an image's length and its height. HDTV images have an aspect ratio of 16:9 and appear elongated. The aspect ratio for standard images is 4:3.
Colour temperature	The temperature of an object which is emitting light. If the colour temperature is high, the colours tend to take on a bluish tinge. If the colour temperature is lower, the colours tend to take on a reddish tinge.
Component video	Video signals which have the video brightness signals and colour signals separated, in order to provide better image quality. In high-definition TV (HDTV), it refers to images which consist of three independent signals: Y (luminance signal), and Pb and Pr (colour difference signals).
Composite video	Video signals which have the video brightness signals and colour signals mixed together. The type of signals commonly used by household video equipment (NTSC, PAL and SECAM formats). The carrier signal Y (luminance signal) and chroma (colour) signal which are contained in the colour bar are overlapped to form a single signal.
Contrast	The relative brightness of the light and dark areas of an image can be increased or decreased in order to make text and graphics stand out more clearly, or to make them appear softer. Adjusting this particular property of an image is called "contrast adjustment".
Cool-down	This is the process by which the projector's lamp is cooled down after it has become hot through use. It is carried out automatically when the [Power] button on either the remote control or the projector's control panel has been pressed to turn the projector off. Do not disconnect the power cord while cool-down is in progress, otherwise the cool-down process will not work properly. If the cool-down period is not allowed to finish normally, the projector's lamp and internal components will remain at high temperatures, and this may shorten the operating life of the lamp or cause problems with the operation of the projector.
DFP	Abbreviation for Digital Flat Panel. Refers to a standard method for digital transmission of video signals.
DHCP	Abbreviation for Dynamic Host Configuration protocol, which is a protocol for automatically assigning an IP address for devices that are connected to a network.
Dolby Digital	A sound format developed by Dolby Laboratories. Normal stereo is a 2-channel format which uses two speakers. Dolby Digital is a 6-channel (5.1-channel) system which adds to this a centre speaker two rear speakers and a sub-woofer.
DVI (DVI-D)	Abbreviation for Digital Visual Interface. Refers to a standard method for digital transmission of video signals. DVI is a standard which has also been applied to digital household electronic equipment other than computers. It allows images to be transmitted at higher resolutions than for DFP, and also includes a digital signal encoding function.



EMP Link21L	A utility software program that allows the projector to be connected to a computer so that the computer can be used to control the projector. For details on acquiring the software and for instructions on using the software and compatible projector models, please visit the web site http://www.epson.co.uk/support/download/projector.htm .
Film judgment function	A function for judging whether an image source is a 24 Hz progressive film source or not.
Gateway	A server (router) that is used for communication over a network (subnet) that is divided up using subnet masks.
HDTV	An abbreviation for High-Definition Television. It refers to high-definition systems which satisfy the following conditions. <ul style="list-style-type: none"> • Vertical resolution of 750p or 1125i or greater (p = progressive scanning, i = interlaced scanning) • Screen aspect ratio of 16:9 • Dolby Digital audio reception and playback (or output)
Interlaced	A method of image scanning whereby the image data is divided into fine horizontal lines which are displayed in sequence starting from left to right and then from the top to the bottom of the screen. The even-numbered lines and odd-numbered lines are displayed alternately.
IP address	A series of numbers that identifies a device that is connected to a network.
MAC address	Abbreviation for Media Access Control address. A MAC address is a unique ID number that is assigned to each network adapter. All network adapters are assigned this unique address, and these are used as the basis for communication between each network adapter.
Progressive	A method of image scanning whereby the image data from a single image is scanned sequentially from top to bottom to create a single image.
Refresh rate	The light-emitting element of a display maintains the same luminosity and colour for an extremely short time. Because of this, the image must be scanned many times per second in order to refresh the light-emitting element. The number of refresh operations per second is called the "refresh rate", and is expressed in hertz (Hz).
Resize display	This function is used to project computer images that have a resolution more than or less than the projector's panel resolution to be projected so that they fill the whole of the projection area.
SDTV	An abbreviation for Standard Definition Television. It refers to standard television systems which do not satisfy the conditions for High-Definition Television.
Security lock	A device consisting of a projector case with a hole in it that a commercially-available theft-prevention cable can be passed through in order to secure the device to a table or pillar. This projector is compatible with the Microsaver Security System manufactured by Kensington.
SNMP	Abbreviation for Simple Network Management Protocol. In TCP/IP networks, this protocol is used for communication between routers and other devices that are connected to the network such as computers and terminals so that these devices can be monitored and controlled over the network.
Squeeze mode	In this mode, wide-screen images in 16:9 mode are compressed in the horizontal direction so that they are stored on the recording medium as 4:3 images. When these images are played back by the projector in squeeze mode, they are restored to their original 16:9 format.
sRGB	An international standard for colour intervals that was formulated so that colours which are reproduced by video equipment can be handled easily by computer operating systems (OS) and the Internet.

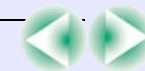

Subnet mask	A series of numbers that define the number of bits to be used for network addresses in a network (subnet) that is divided up according to IP addresses.
SVGA	A type of video signal with a resolution of 800 (horizontal) \times 600 (vertical) dots which is used by IBM PC/AT-compatible computers.
S-Video	A video signal which has the luminance component and colour component separated in order to provide better image quality. It refers to images which consist of two independent signals: Y (luminance signal), and C (colour signal).
SXGA	A type of video signal with a resolution of 1280 (horizontal) \times 1024 (vertical) dots which is used by IBM PC/AT-compatible computers.
Sync (Synchronisation)	The signals output from computers have a specific frequency. If the projector frequency does not match this frequency, the resulting images will not be of a good quality. The process of matching the phases of these signals (the relative position of the crests and troughs in the signal) is called "synchronisation". If the signals are not synchronized, problems such as flickering, blurriness and horizontal interference can occur.
Tracking	The signals output from computers have a specific frequency. If the projector frequency does not match this frequency, the resulting images will not be of a good quality. The process of matching the frequency of these signals (the number of crests in the signal) is called "tracking". If tracking is not carried out correctly, wide vertical stripes will appear in the projected images.
Trap IP address	An IP address for the destination computer when SNMP reports that a problem has occurred.
USB	An abbreviation for Universal Serial Bus. USB is an interface for connecting personal computers to peripheral devices which only support relatively low data transmission speeds.
UXGA	A type of video signal with a resolution of 1600 (horizontal) \times 1200 (vertical) dots which is used by IBM PC/AT-compatible computers.
VGA	A type of video signal with a resolution of 640 (horizontal) \times 480 (vertical) dots which is used by IBM PC/AT-compatible computers.
XGA	A type of video signal with a resolution of 1024 (horizontal) \times 768 (vertical) dots which is used by IBM PC/AT-compatible computers.
YCbCr	The carrier signal which is contained in the colour bar signal used in modern TV transmissions. The name comes from the Y (luminance) signal and the CbCr (chroma (colour)) signals.
YPbPr	The carrier signal which is contained in the colour bar signal used in high-definition TV (HDTV) transmissions. The name comes from the Y (luminance) signal and the PbPr (colour difference) signals.



Command List

When a power ON command is sent to the projector, the power for the projector turns on. When the projector is in a command ready state, it returns the "3Ah" (:) code.

Furthermore, when command processing is complete, the projector also returns a ":" code.

The ":" code status can be used to determine whether the projector is ready or busy. If command processing terminates with an error, an error message is output and then the ":" code is sent.

	Item	Command
Power ON/OFF	ON	PWR ON
	OFF	PWR OFF
Signal selection	Computer 1	SOURCE 10
	Computer 2	SOURCE 20
	DVI▶	SOURCE 30
	Video	SOURCE 41
	S-Video	SOURCE 42
A/V Mute ON/OFF	BNC	SOURCE B0
	ON	MUTE ON
A/V Mute Selection	OFF	MUTE OFF
	Black	MSEL 00
	Blue	MSEL 01
	User's Logo	MSEL 02

Communication Protocol

- Standard baud rate : 9600 bps
- Data length : 8 bits
- Parity : None
- Stop bit : 1 bit
- Flow control : None
- Connector shape : D-Sub 9-pin (male)
- Projector input port : Control (RS-232C)

Cable Layouts

Serial connection

- Connector shape : D-Sub 9-pin (male)
- Projector input connector : Control (RS-232C)

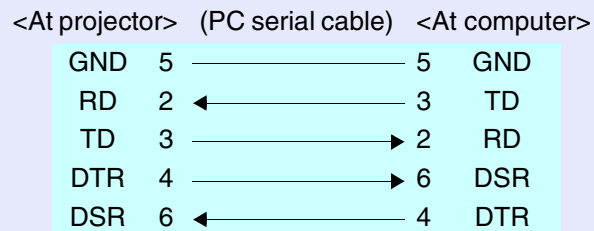
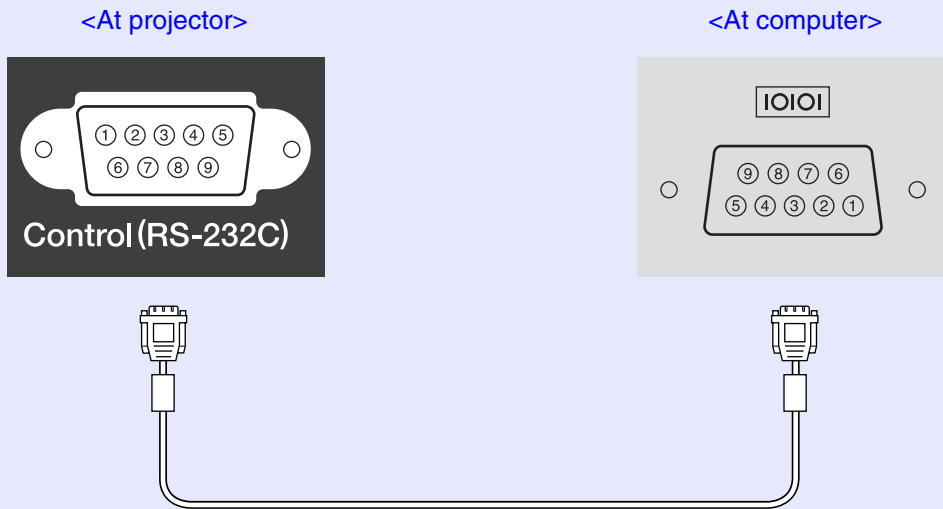

Signal	Function
GND	Signal wire earth
TD	Transmit data
RD	Receive data
DSR	Data set ready
DTR	Data terminal ready

USB connection

- Connector shape : USB(type B)

<At projector>



(type B)

<At computer>

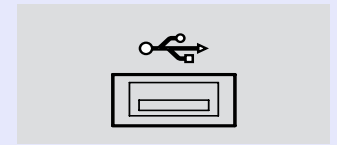

USB Connection Setup

In order to control the projector using ESC/VP21 commands via a USB connection, the following preparations must be carried out.

PROCEDURE

- 1** Download the [EMP Link21L](#) utility software from the EPSON website to the computer being used.

For details on acquiring the software, please visit the Web site <http://www.epson.co.uk/support/download/projector.htm>.

- 2** The USB driver (USB-COM Driver) will be downloaded together with the utility software, so install this USB driver on the computer that is to be used.

Refer to the EMP Link21L User's Guide that is downloaded together with the utility software for instructions on installing the USB driver.

- 3** Change the "COM Port" setting in the "Advanced2" menu to "USB".

- 4** Turn the projector off.

- 5** After the [cool-down](#) period has finished, turn the projector's power back on.

Once the projector's power has turned back on, communication via a USB connection will then be possible.



CAUTION

If the power cable is disconnected before cool-down has finished, the communication port will not be changed.

■ Computer/RGB Video

Signal	Refresh rate ^{▶▶} (Hz)	Resolution (dots)	Resolutions for
			resized display ^{▶▶} (dots)
VGA/EGA		640×350	1024×560
VGA ^{▶▶}	60/72/75/85/100/ 120, iMac ^{*1}	640×480	1024×768
SVGA ^{▶▶}	56/60/72/75/85/ 100/120, iMac ^{*1}	800×600	1024×768
XGA ^{▶▶}	60/70/75/85/100/ 120, iMac ^{*1}	1024×768	1024×768
SXGA ^{▶▶}	70/75/85/100	1152×864 ^{*2}	1024×768
SXGA	60/75/85	1280×960 ^{*2}	1024×768
		1280×1024 ^{*2}	960×768
SXGA+	60/75/85	1400×1050 ^{*2}	1024×768
UXGA ^{▶▶}	60/65/70/75/80/85	1600×1200 ^{*2}	1024×768
MAC13"		640×480	1024×768
MAC16"		832×624	1024×768
MAC19"		1024×768	1024×768
MAC21"		1152×870 ^{*2}	1016×768
SDTV ^{▶▶} (525i, 525p, 625i, 625p)			1024×768 (4:3 aspect ratio ^{▶▶}) 1024×576 (16:9 aspect ratio)
HDTV ^{▶▶} (750p)			1024×576
HDTV (1125i, 1125p)			1024×576

*1 Connection is not possible if the equipment does not have a VGA output port.

*2 The resolution for real display is the virtual (window) display resolution.

It may be possible to project signals which are not listed in the above table. However, not all functions may be supportable with such signals.

■ Component Video

Signal	Display mode (dots)	
	4:3 aspect ratio ^{▶▶} display	16:9 aspect ratio display
SDTV ^{▶▶} (525i, 525p, 625i, 625p)	1024×768	1024×576
HDTV ^{▶▶} (750p) 16:9	–	1024×576
HDTV(1125i) 16:9	–	1024×576

■ Composite Video/S-Video

Signal	Display mode (dots)	
	4:3 aspect ratio ^{▶▶} display	16:9 aspect ratio display
TV(NTSC)	1024×768	1024×576
TV (PAL,SECAM)	1024×768	1024×576

Product name	Multimedia Projector EMP-8300/8300NL
Dimensions	349 (W) × 179 (H) × 491 (D) mm (13.7 (W) × 7.0 (H) × 19.3 (D) in.) (not including feet)
Panel size	1.4 inches
Display method	Polysilicon TFT
Resolution	XGA ▶ 786,432 pixels (1024 (W) × 768 (H) dots) × 3
Focus adjustment*1	Electronic
Zoom adjustment*1	Electronic (approx. 1:1.35)
Lens shift*1	Electronic (10:0–0:10)
Lamp (light source)	UHE lamp, Rated 320 W, Model No.: ELPLP23
Max. audio output	7 W monaural
Speaker	1
Power supply	100–240 VAC 5.4–2.5 A 50/60 Hz
Operating temperature	+5°– +40°C (41°–95°F) (No condensation)
Storage temperature	-10°– +60°C (14°–140°F) (No condensation)
Weight	EMP-8300 : Approx. 11.2 kg (24.7 lbs) EMP-8300NL : Approx. 9.2 kg (20.3 lbs) (without lens)

Connectors	DVI:	1	DVI-D
	Audio input:	1	Stereo mini jack
	Computer 1:	1	Mini D-Sub 15-pin (female) Blue
	Audio input:	1	Stereo mini jack
	Computer 2:	1	Mini D-Sub 15-pin (female) Blue
	Audio input:	1	Stereo mini jack
	USB *2:	1	USB connector (type B)
	BNC:	1	5BNC (female)
	Audio input:	1	RCA pin jack × 2 (L, R)
	S-Video:	1	Mini DIN 4-pin
	Audio input:	1	RCA pin jack × 2 (L, R)
	Video:	1	RCA pin jack
	Audio input:	1	RCA pin jack × 2 (L, R)
	Control (RS-232C):	1	D-Sub 9-pin (male)
Remote:	1	Stereo mini jack	
Monitor Out:	1	Mini D-sub 15-pin (female) Black	
Audio Out:	1	Stereo mini jack	
Network:	1	RJ-45	

*1 These values are for when the standard lens is fitted. Refer to the documentation supplied with optional lenses for details on those lenses.

*2 The USB connector is not guaranteed to operate correctly with all USB-compatible devices.



Safety

USA

UL1950 3rd Edition

Canada

CSA C22.2 No.950-95 (cUL)

European Community

The Low Voltage Directive (73/23/EEC)

IEC60950 2nd Edition, +Amd.1, +Amd.2, +Amd.3, +Amd.4

EMC

USA

FCC 47CFR Part15B Class B (DoC)

Canada

ICES-003 Class B

European Community

The EMC Directive (89/336/EEC)

EN55022, 1998 Class B

EN55024, 1998

IEC61000-4-2, IEC61000-4-3, IEC61000-4-4, IEC61000-4-5,

IEC61000-4-6, IEC61000-4-8, IEC61000-4-11,

IEC61000-3-2, IEC61000-3-3

Australia/New Zealand

AS/NZS 3548:1995, A1:1997, A2:1997 Class B

CISPR Pub.22:1993, A1:1995, A2:1996, Class B



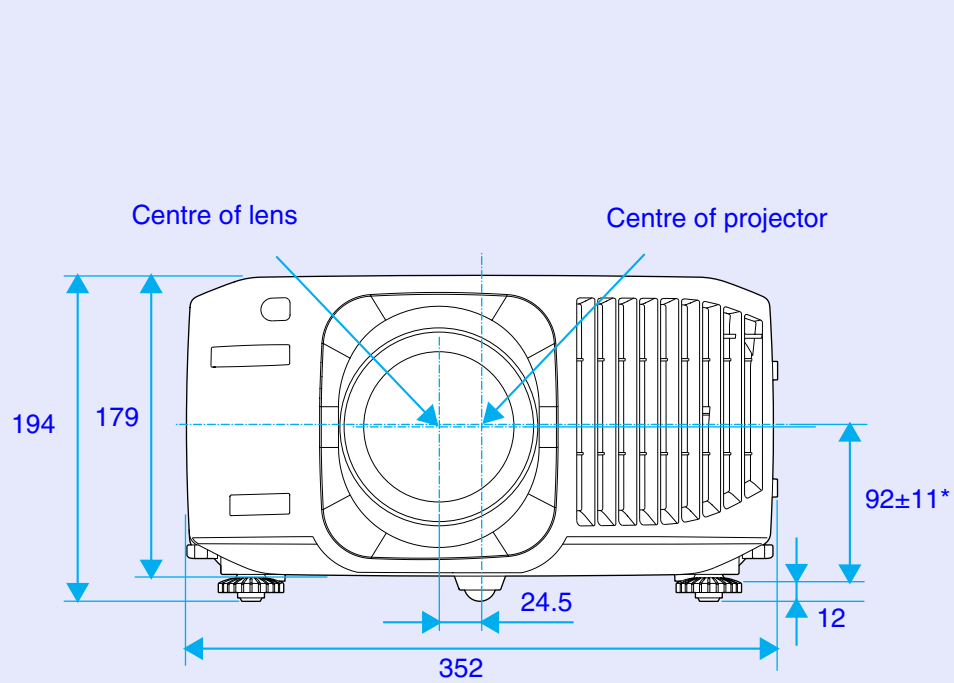

*Distance from center of lens to suspension bracket fixing point
(The centre of the lens moves vertically when using the lens shift.)

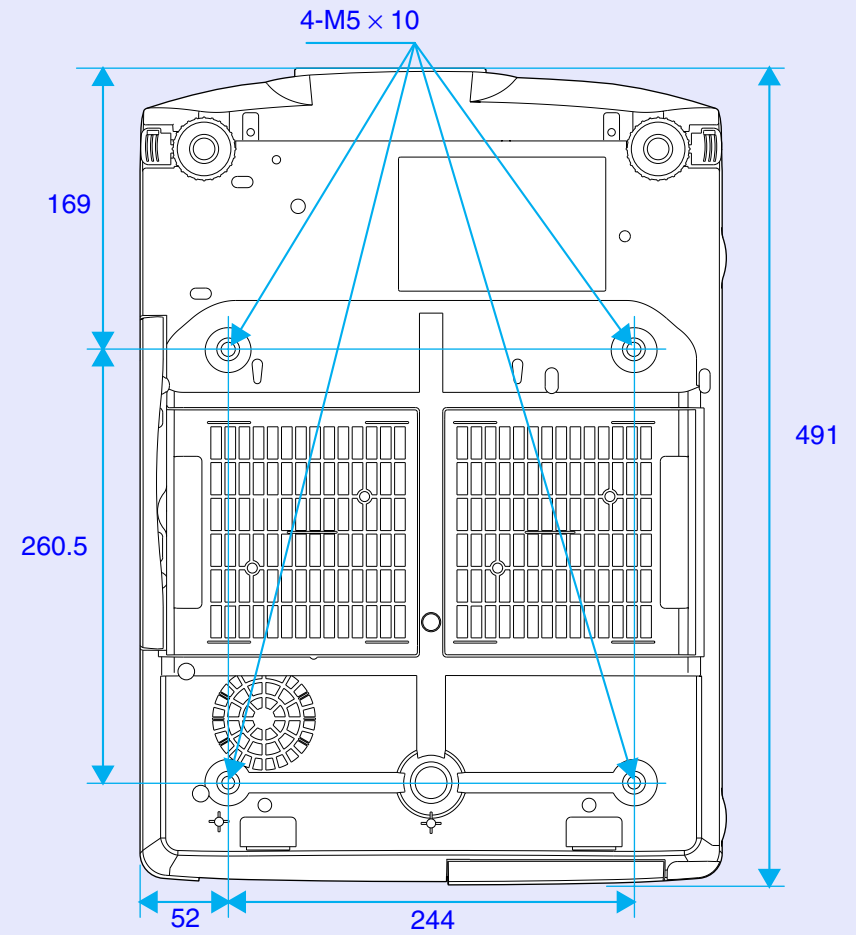

Units: mm

General Terms

13w3 port..... 19
5BNC port 20

A

A/V Mute..... 58, 80
"About" Menu..... 88
"Advanced 1" Menu 83
"Advanced 2" Menu 86
Air exhaust vent..... 7
Air filter 8
Air intake vent 7
Analogue-RGB 73, 88
Aspect ratio..... 68
Audio cable..... 29
Audio port..... 11, 29
"Audio" Menu..... 78
Audio out port..... 11, 29
Auto Setup 52, 86

B

Bass..... 78
Battery insertion and replacement
period 12
Black Level..... 84
BNC Input 81

BNC Sync Termination 86
Brightness..... 73, 76
Brightness Control 86

C

Cable cover..... 34
Ceiling 15, 85
Cleaning the Air Filter 122
Cleaning the Lens..... 122
Cleaning the Projector Case 122
Color..... 76
Color Adjustment..... 84
Color Mode 55, 74, 77
Color temperature..... 84
COM Port..... 86
Component video 26
Computer1 Input 80
Computer 1 port 11
Computer2 Input 81
Computer 2 port 11
Composite video..... 25
Computer cable 18
Connecting to a Computer 17
Connecting to a Video Source..... 25
Contrast 73, 76
Control (RS-232C) port..... 11
Control panel..... 9

Cool-down 41, 111
Correcting keystone distortion..... 47
Cross 59
Curved Line 63

D

DHCP..... 95
Digital-RGB..... 73, 88
Dynamic..... 55, 74, 77

E

Effect Function 62
Eligible computers 17
EMP Link21L 139
EMP Monitor function..... 101
EMP NetworkManager 96
ESC/VP21 137
External monitor 32
E-Zoom 59

F

Focus..... 44
Focus Adjustment 44
Foot adjustment..... 46
Freeze..... 59
Frequency..... 88

Front adjustable foot..... 7

G

Gateway Address..... 95
Glossary..... 134

H

Handle 7
HDTV 140
Height correction..... 50
Help function..... 107
High..... 86

I

Image size..... 16, 43
Indicators 7, 109
Input Signal 88
Installation 93
IP address 95

K

Keystone 47, 49, 80

L

Lamp..... 88
Lamp cover 8



Lamp indicator..... 7, 109
 Lamp replacement period 123
 Language 85
 Lens cover..... 7
 Lens Shift Adjustment..... 45
 Low 86
 Living Room..... 55, 74, 77

M

MAC address 96
 Mail notification function..... 96
 Main menu..... 72
 Menu..... 72
 Message 80
 Mini D-Sub 15-pin port..... 18
 Monitor Out port..... 11
 Mouse pointer 24

N

Network 92
 Network port..... 11
 No-Signal Msg..... 80
 Numeric buttons 10, 95

O

Operating environment 92

Operation indicator.....7, 109
 Operating distance
 (Remote control) 14
 Operating range
 (Remote control) 14
 Operating temperature..... 141
 Optional Accessories..... 132
 Overheating 110

P

Part Names and Functions.....7
 P in P function.....60
 Pointer62
 Pointer Speed79
 Port 11, 38
 Position.....52, 73, 76
 Power cable36
 Power inlet.....8
 Presentation55, 74, 77
 Preset74
 Preset Function.....64
 Preview Function.....39
 Problem Solving.....109
 Progressive83
 Projection36
 Projection angle.....44
 Projection distance16
 Projector ID.....69

Projector name 97
 Projector Software 93

Q

Quick Corner 47

R

Real display 67
 Rear Proj. 15, 84
 Refresh Rate..... 88
 Remote control..... 10, 12, 13, 23
 Remote Control ID 69
 Remote control
 light-emitting area..... 10
 Remote control
 light-receiving area 7, 8
 R/C switch 10, 13
 Remote port 10, 11
 Replacing the Air Filter 127
 Replacing the Lamp 124
 "Reset All" Menu..... 89
 Reset Lamp Timer 88, 126
 Resized display 67
 Resolution 74, 140
 RGB 84
 RGB Video..... 27

S

Screen size 16
 Security lock.....7
 "Setting" Menu80
 Setting Up the Projector 15
 Sharpness.....73, 76
 Sleep Mode.....81
 SNMP96
 Source.....88
 Speaker7, 29, 31
 Specifications141
 Squeeze mode.....68
 sRGB55, 74, 77
 Standby Mode 85
 Standby monitor out function.....33
 Startup screen 83
 Storage temperature.....141
 Straight line63
 Sub-menu72
 Subnet mask95
 Supported Monitor Displays140
 Suspension bracket
 fixing point8, 143
 S-Video26, 76, 88
 S-Video port 11
 Sync52, 73

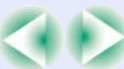

SYNC Mode 88
SYNC Polarity 88

T

Temperature indicator 7, 109
Theatre 55, 74, 77
Tint 76
Tracking 52, 73
Translucent screen 15
Transmission event 98
Treble 78
Turning off 41

U

USB cable 23
USB connection setup 139
USB mouse 23
USB port 11
User's Logo 58, 129
"User's Logo" Menu 82
Using the Configuration Menu
 Functions 72
Uninstalling 94

V

Vertical keystone correction 49
Video 76, 88

"Video" Menu 73
Video port 11
Video Signal 77, 88
Volume 56

W

White Level 84
Wide-screen Projection 68
Wireless Mouse Function 23
Workstation 19

Y

YCbCr 38, 76, 88
YPbPr 38, 76, 88

Z

Zoom Function 43



DECLARATION of CONFORMITY

According to 47CFR, Part 2 and 15
Class B Personal Computers and Peripherals; and/or
CPU Boards and Power Supplies used with Class B
Personal Computers

We :EPSON AMERICA, INC.
Located at :3840 Kilroy Airport Way
MS: 3-13
Long Beach, CA 90806
Tel :562-290-5254

Declare under sole responsibility that the product identified herein, complies with 47CFR Part 2 and 15 of the FCC rules as a Class B digital device. Each product marketed, is identical to the representative unit tested and found to be compliant with the standards. Records maintained continue to reflect the equipment being produced can be expected to be within the variation accepted, due to quantity production and testing on a statistical basis as required by 47CFR 2.909. Operation is subject to the following two conditions : (1) this device may not cause harmful interference, and (2) this device must accept any interference received, including interference that may cause undesired operation.

Trade Name :EPSON
Type of Product :Projector
Model :EMP-8300 / EMP-8300NL

**FCC Compliance Statement
For United States Users**

This equipment has been tested and found to comply with the limits for a Class B digital device, pursuant to Part 15 of the FCC Rules. These limits are designed to provide reasonable protection against harmful interference in a residential installation. This equipment generates, uses, and can radiate radio frequency energy and, if not installed and used in accordance with the instructions, may cause harmful interference to radio or television reception. However, there is no guarantee that interference will not occur in a particular installation. If this equipment does cause interference to radio and television reception, which can be determined by turning the equipment off and on, the user is encouraged to try to correct the interference by one or more of the following measures.

- Reorient or relocate the receiving antenna.
- Increase the separation between the equipment and receiver.
- Connect the equipment into an outlet on a circuit different from that to which the receiver is connected.
- Consult the dealer or an experienced radio/TV technician for help.

WARNING

The connection of a non-shielded equipment interface cable to this equipment will invalidate the FCC Certification or Declaration of this device and may cause interference levels which exceed the limits established by the FCC for this equipment. It is the responsibility of the user to obtain and use a shielded equipment interface cable with this device. If this equipment has more than one interface connector, do not leave cables connected to unused interfaces. Changes or modifications not expressly approved by the manufacturer could void the user's authority to operate the equipment.

All rights reserved. No part of this publication may be reproduced, stored in a retrieval system, or transmitted in any form or by any means, electronic, mechanical, photocopying, recording, or otherwise, without the prior written permission of SEIKO EPSON CORPORATION. No patent liability is assumed with respect to the use of the information contained herein. Neither is any liability assumed for damages resulting from the use of the information contained herein.

Neither SEIKO EPSON CORPORATION nor its affiliates shall be liable to the purchaser of this product or third parties for damages, losses, costs, or expenses incurred by purchaser or third parties as a result of: accident, misuse, or abuse of this product or unauthorized modifications, repairs, or alterations to this product, or (excluding the U.S.) failure to strictly comply with SEIKO EPSON CORPORATION's operating and maintenance instructions.

SEIKO EPSON CORPORATION shall not be liable against any damages or problems arising from the use of any options or any consumable products other than those designated as Original EPSON Products or EPSON Approved Products by SEIKO EPSON CORPORATION.

General Notice:

EPSON is a registered trademark of SEIKO EPSON CORPORATION. Macintosh, Mac, and iMac are registered trademarks of Apple Computer, Inc.

IBM is a registered trademark of International Business Machines Corporation.

Windows and Windows NT are trademarks of Microsoft Corporation in the United States of America.

Dolby is registered trademarks of Dolby Laboratories.

Other product names used herein are also for identification purposes only and may be trademarks of their respective owners. EPSON disclaims any and all rights in those marks.